

DIY CATALOGUE



— europe
pgb

4 INTRODUCTION

10 LEXICON

12 FASTENERS FOR WOOD

80 BLACKTOP

90 FASTENERS FOR METAL

138 STAINLESS STEEL FASTENERS

180 NYLON FASTENERS

190 NAILS

214 HOOKS & EYES

230 HAPAX WOOD SCREWS

pgb - Europe

EN Fasteners and fixings. From small screws to ETA approved construction bolts. From nylon plugs to seismic tested anchors. These are the visible or invisible connections that keep building projects together. They are indispensable links. For pgb it is our daily aim to provide our customers with quality products and a matching service. We have been an established supplier and manufacturer of fasteners and fixings for more than 60 years. It has been in our DNA for 3 generations.

“A perfect mix of 60 years of experience, a high product quality and a professional approach”

With our extensive range of products, we provide everything our customers need for their everyday and specific needs when it comes to fasteners. pgb-Europe has been active for a long time in various committees at a local and European level so that we are always up to date with specific guidelines and standards.

In order to distinguish our wide product range, pgb-Europe has seven of its own brands with their own look and feel. There is always one constant: the commitment 'Quality by pgb'.

NL Bevestigingsmaterialen. Van kleine schroefjes tot Europees genormeerde constructiebouten. Van nylon pluggen tot seismisch gekeurde verankeringen. Het zijn de zichtbare of onzichtbare verbindingen die bouwprojecten tesamen houden. Het zijn onmisbare schakels. Voor pgb is het ons dagelijks streven onze klanten te voorzien van kwaliteitsproducten en een bijpassende service. Al meer dan 60 jaar zijn wij een gevestigde waarde als leverancier en fabrikant van bevestigingsmaterialen. Het zit al 3 generaties in onze genen.

“Een perfecte mix van 60 jaar ervaring, een hoge productkwaliteit en een professionele aanpak”

Met ons uitgebreide assortiment voorzien wij onze klanten in hun alledaagse en specifieke behoeften aan bevestigingsmaterialen. pgb-Europe is reeds lange tijd actief in diverse commissies op lokaal en Europees niveau zodat we steeds op de hoogte zijn van richtlijnen en normen.

Om de brede waaier van ons productassortiment te kunnen onderscheiden, heeft pgb-Europe een 7-tal eigen merken met een eigen uitstraling. Er is telkens één constante: de commitment 'Quality by pgb'.



FR Visserie et fixations. De petites vis aux boulon de construction normalisés, des chevilles nylon aux ancrages homologués anti-sismiques, nos fixations, visibles ou invisibles permettent d'assembler toute forme de construction. Ce sont des liens indispensables. Pour pgb, notre objectif quotidien est de fournir à nos clients des produits de qualité et un service approprié. Depuis plus de 60 ans, nous sommes fournisseur et fabricant renommé d'éléments de fixations. C'est dans nos gènes depuis 3 générations.

***“Un mélange parfait de
60 ans d'expérience,
de produits de haute
qualité et d'une approche
professionnelle”***

Avec notre vaste gamme de produits, nous répondons aux besoins quotidiens et spécifiques de nos clients en matière de fixations. pgb-Europe participe activement à divers comités au niveau local et européen afin de toujours être au courant des directives et des normes en vigueur.

Afin de distinguer les groupes de produits de notre assortiment, pgb-Europe dispose de 7 marques propres clairement identifiées. Il y a toujours une constante: l'engagement 'Quality by pgb'.

DE Befestigungen und Verbindungen. Von kleinen Schrauben bis hin zu ETA-zugelassenen Baubolzen. Von Nylon-Steckern bis zu erdbebensicheren Ankern. Dies sind die sichtbaren oder unsichtbaren Verbindungen, die Bauprojekte zusammenhalten. Sie sind unentbehrliche Verbindungen. Für pgb ist es unser tägliches Ziel, unseren Kunden Qualitätsprodukte und einen entsprechenden Service zu bieten. Wir sind seit mehr als 60 Jahren ein etablierter Lieferant und Hersteller von Befestigungen und Verbindungen. Es ist in unseren Genen seit 3 Generationen.

***“Eine perfekte Mischung
aus 60 Jahren Erfahrung,
hoher Produktqualität und
professioneller Ansatz”***

Mit unserem umfangreichen Produktsortiment bieten wir alles, was unsere Kunden für ihre täglichen und spezifischen Bedürfnisse bei Schnellelementen benötigen. pgb-Europe ist seit langer Zeit in verschiedenen Gremien auf lokaler und europäischer Ebene tätig, so dass wir immer auf dem neuesten Stand spezifischer Richtlinien und Standards sind.

Um unsere breite Produktpalette zu unterscheiden, hat pgb-Europe sieben eigene Marken mit eigenem Look und Feel. Es gibt immer eine Konstante: das Engagement 'Quality by pgb'.

Stock



EN Stock Management

Unleash the power of Stock Management with pgb-Europe. In partnership with our trusted partners in the Far East and Europe, pgb-Europe's efficient purchasing management we strive to a delivery rate of 97%. With over 35,000 items in stock, 25.000 pallet locations and 40.000 bin locations in our state-of-the-art automated warehouse.

Streamline your operations with our solutions. Our expertise and investment in cutting-edge technology ensures that we consistently meet the highest standards. Our fully automated storage system guarantees accurate and speedy order processing.

NL Stock Management

Beheers uw voorraad met pgb-Europe. In samenwerking met onze vertrouwde partners in het Verre Oosten en Europa garandeert het efficiënt aankoopbeheer van pgb-Europe een hoge uitleveringsgraad tot 97%. Met meer dan 35.000 artikelen op voorraad, 25.000 palletlocaties en 40.000 baklocaties in ons geavanceerde geautomatiseerde magazijn.

Optimaliseer uw bedrijfsprocessen met onze oplossingen. Onze deskundigheid en investering in de nieuwste technologieën zorgen ervoor dat we altijd aan de hoogste eisen voldoen. Ons volledig geautomatiseerde opslagsysteem garandeert een nauwkeurige en snelle afhandeling van bestellingen.

FR Stock Management

Gérez votre stock avec pgb-Europe. En collaboration avec nos partenaires de confiance en Asie et en Europe, la gestion efficace de l'achat de pgb-Europe garantit un taux de livraison de 97%. Avec plus de 35.000 articles en stock, 25.000 emplacements de palette et 40.000 emplacements de boîte dans notre entrepôt automatisé avancé.

Optimisez vos processus d'entreprise avec nos solutions. Notre expertise et notre investissement dans les dernières technologies nous permettent de toujours répondre aux plus hautes exigences. Notre système de stockage entièrement automatisé garantit une gestion rapide et précise des commandes.

DE Stock Management

Verwalten Sie Ihre Lagerbestände mit pgb-Europe. In Zusammenarbeit mit unseren vertrauenswürdigen Partnern im Fernen Osten und Europa garantiert das effiziente Einkaufsmanagement von pgb-Europe eine Lieferquote von 97%. Mit mehr als 35.000 Artikeln auf Lager, 25.000 Palettenplätzen und 40.000 Kartonplätzen in unserem fortschrittlichen, automatisierten Lager.

Optimieren Sie Ihre Geschäftsprozesse mit unserem System. Dank unseres Fachwissens und unserer Investitionen in die neuesten Technologien können wir stets den höchsten Anforderungen gerecht werden. Unser vollautomatisches Lagersystem Maestro garantiert eine schnelle und präzise Auftragsabwicklung.

Merchandising



EN At pgb-Europe, we are here to support and advise you. Through our merchandising service, we can also help you with your shop layout and replenish your stock.

By mutual agreement, we propose tailor-made shelf plans. You can count on our many years of experience to preselect the most current fasteners for your customers.

Naturally, pgb-Europe provides the necessary marketing communication tools. Some examples include: flyers, visual material, POS material, customised labels and tags.

NL Bij pgb-Europe zijn we er om u te ondersteunen en te adviseren. Via onze merchandising service kunnen wij u ook helpen met winkelinrichting en het aanvullen van de voorraad.

In overleg stellen wij schappenplannen op maat voor. U kunt rekenen op onze jarenlange ervaring om de meest actuele bevestigingsmaterialen voor uw klanten te selecteren.

Natuurlijk zorgt pgb-Europe voor de nodige marketingcommunicatie-instrumenten. Enkele voorbeelden hiervan zijn: flyers, beeldmateriaal, POS-materiaal, labels en etiketten op maat.

FR Chez pgb-Europe, nous sommes là pour vous soutenir et vous conseiller. Grâce à notre service merchandising, nous pouvons également vous aider dans l'aménagement de votre magasin et le réapprovisionnement de votre stock.

En concertation avec vous, nous proposons des plans de rayonnage sur mesure. Vous pouvez compter sur nos nombreuses années d'expérience pour présélectionner les fixations les plus utiles pour vos clients.

Naturellement, pgb-Europe fournit les outils de communication marketing nécessaires. Quelques exemples : flyers, matériel visuel, matériel de PLV, étiquettes personnalisées et tags.

DE Bei pgb-Europe sind wir für Sie da, um Sie zu unterstützen und zu beraten. Dank unserer Merchandising-Abteilung können wir Ihnen auch bei der Einrichtung Ihres Ladens und der Auffüllung Ihrer Bestände helfen.

In Absprache mit Ihnen bieten wir maßgeschneiderte Regalpläne an. Sie können sich auf unsere langjährige Erfahrung verlassen, wenn es darum geht, eine Vorauswahl der für Ihre Kunden nützlichsten Befestigungen zu treffen.

Selbstverständlich stellt pgb-Europe die notwendigen Marketingkommunikationsmittel zur Verfügung. Einige Beispiele sind: Flyer, visuelles Material, POS-Material, maßgeschneiderte Etiketten und Anhänger.

E-shop & app



E-shop

Order easily and quickly with our e-shop. Once you are logged in, you will have access to your personal dashboard where you will have an overview of all your orders. Furthermore, you will receive exclusive news and update messages about products and events that are relevant to you. We try to optimize the ordering process as much as possible to fit your needs.

You will find our most recent catalogs, brochures, and inspections in the download section of our website.

pgb app

At pgb, we believe in the constantly evolving technology to improve your shopping experience. Our integrated barcode scanner allows you to reorder products in an instant. You can complete your orders immediately or save them for later in the shopping cart.

Never miss a thing with real-time access to product information, stock availability, and delivery status via the pgb app. Upgrade your shopping experience with pgb today.

E-shop

Bestel eenvoudig en snel met onze e-shop. Zodra je bent ingelogd, krijg je toegang tot je persoonlijke dashboard waar je een overzichtelijk beeld krijgt van al je bestellingen. Bovendien ontvang je exclusieve nieuws- en updateberichten over producten en evenementen die voor jou relevant zijn. We proberen het bestelproces zo maximaal mogelijk op jouw maat te optimaliseren.

Je vindt onze meest recente catalogi, brochures en keuringen onder de downloadsectie van onze website.

pgb app

Bij pgb geloven we in de constant evoluerende technologie om jouw winkelervaring te verbeteren. Onze geïntegreerde barcodescanner stelt je in staat om producten in een oogwenk opnieuw te bestellen. Je kunt je bestellingen direct afronden of bewaren voor later in het winkelwagentje.

Mis nooit meer iets met real-time toegang tot productinformatie, voorraadbeschikbaarheid en leverstatus via de pgb-app. Upgrade je winkelervaring met pgb vandaag.

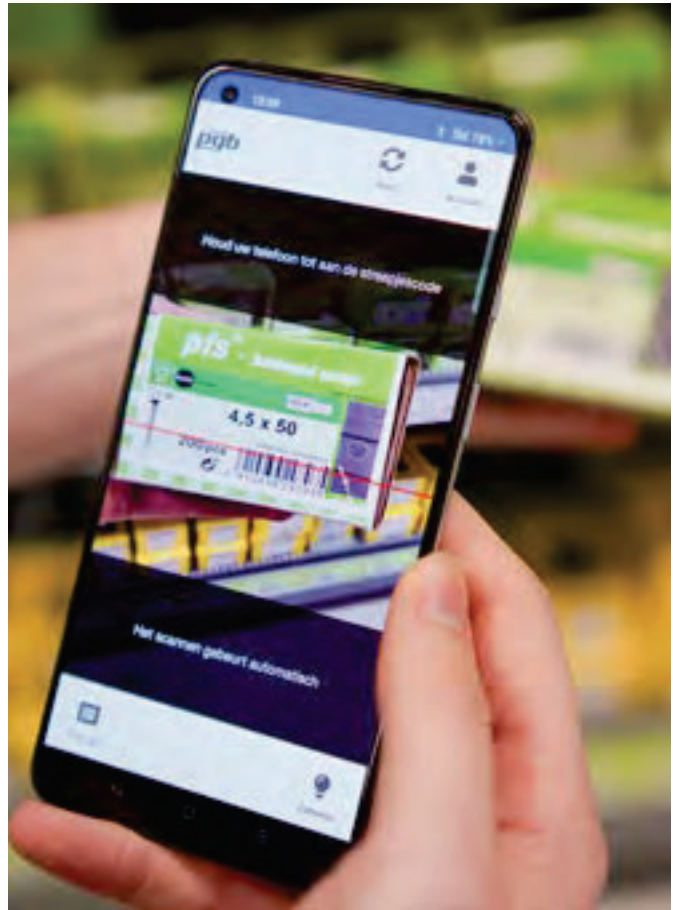

FR E-shop

Commandez facilement et rapidement avec notre e-boutique. Une fois connecté, vous aurez accès à votre tableau de bord personnel où vous aurez un aperçu de toutes vos commandes. De plus, vous recevrez des nouvelles et des mises à jour exclusives sur les produits et les événements pertinents pour vous. Nous essayons d'optimiser le processus de commande autant que possible pour répondre à vos besoins.

Vous trouverez nos catalogues, brochures et inspections les plus récents dans la section de téléchargement de notre site web.

pgb app

Chez pgb, nous croyons en la technologie en constante évolution pour améliorer votre expérience d'achat. Notre scanner de code-barres intégré vous permet de commander des produits instantanément. Vous pouvez compléter vos commandes immédiatement ou les enregistrer pour plus tard dans le panier d'achat.

Ne manquez rien grâce à un accès en temps réel à des informations sur les produits, la disponibilité en stock et le statut de livraison via l'application pgb. Améliorez votre expérience d'achat avec pgb dès aujourd'hui.

DE E-shop

Bestelle bequem und schnell über unseren E-Shop. Sobald Sie angemeldet sind, haben Sie Zugang zu Ihrem persönlichen Dashboard, auf dem Sie einen Überblick über alle Ihre Bestellungen haben. Darüber hinaus erhalten Sie exklusive Nachrichten und Updates zu Produkten und Veranstaltungen, die für Sie relevant sind. Wir versuchen, den Bestellprozess so weit wie möglich an Ihre Bedürfnisse anzupassen.

Sie finden unsere aktuellsten Kataloge, Broschüren und Überprüfungen im Downloadbereich unserer Website.

pgb app

Bei pgb glauben wir an die ständig evolvierende Technologie, um Ihr Einkaufserlebnis zu verbessern. Unser integrierter Barcode-Scanner ermöglicht es Ihnen, Produkte sofort nachzubestellen. Sie können Ihre Bestellungen sofort abschließen oder sie für später im Warenkorb speichern.

Mit Echtzeit-Zugang zu Produktinformationen, Lagerverfügbarkeit und Lieferstatus über die pgb-App verpassen Sie nichts. Upgrade dein Einkaufserlebnis mit pgb heute.

BLISTER TYPES

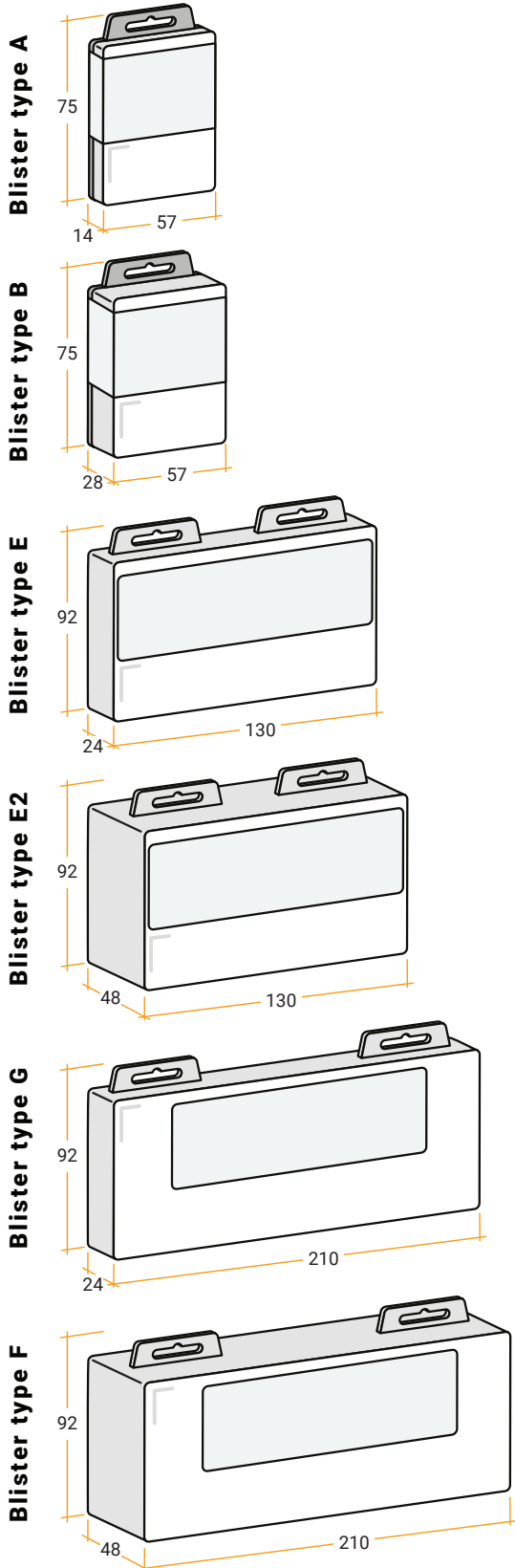

PLASTIC BOX TYPES

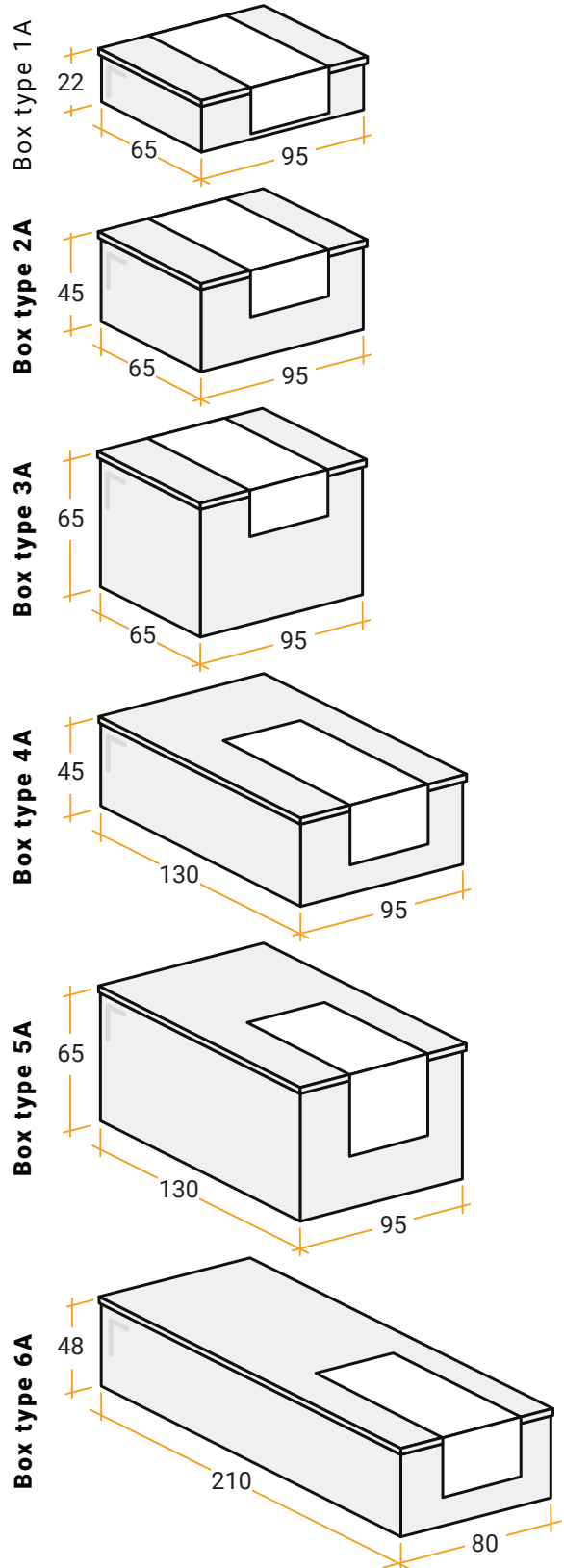

ICONS

	Verzinkt Zinguée Zinc plated Verzinkt		RVS C2 Inox C2 Stainless steel C2 Edelstahl C2		Sterkteklasse 4 Classe de résistance 4 Property class 4 Fertigkeitsklasse 4
	Geelverzinkt Zingué jaune Yellow zinc plated Gelbverzinkt		RVS A2 Inox A2 Stainless steel A2 Edelstahl A2		Sterkteklasse 4.8 Classe de résistance 4.8 Property class 4.8 Fertigkeitsklasse 4.8
	Vuurverzinkt Galvanisé à chaud Hot dip galvanised Feuerverzinkt		RVS A4 Inox A4 Stainless steel A4 Edelstahl A4		Sterkteklasse 5 Classe de résistance 5 Property class 5 Fertigkeitsklasse 5
	Gefosfateerd Phosphaté Phosphated Fosfatiert		Aluminium-staal Aluminium-acier Aluminum-steel Aluminium-Stahl		Sterkteklasse 6 Classe de résistance 6 Property class 6 Fertigkeitsklasse 6
	BlackTop coating BlackTop coating BlackTop coating BlackTop coating		RVS A2-RVS A2 Inox A2-inox A2 Stainless steel A2-A2 Edelstahl A2-Edelstahl A2		Sterkteklasse 8 Classe de résistance 8 Property class 8 Fertigkeitsklasse 8
	Blank staal Acier brut Plain steel Blank Stahl		Aluminium-RVS A2 Aluminium-inox A2 Aluminum-stainless steel A2 Aluminium-Edelstahl A2		Sterkteklasse 8 Classe de résistance 8 Property class 8 Fertigkeitsklasse 8
	Gehard staal Acier trempé Hardened steel Gehärteter Stahl		Messing Laiton Brass Messing		Sterkteklasse 8.8 Classe de résistance 8.8 Property class 8.8 Fertigkeitsklasse 8.8
	Wit geplastificeerd Plastifié blanc White plastified Weiß plastifiziert		Messing-nickel Laiton-nickel Brass-nickel Messing-nickel		Hardheidsklasse 45H Dureté 45H Hardness 45H Härte 45H
	Nylon-PA6 Nylon-PA6 Nylon-PA6 Nylon-PA6		Vernikkeld Nickelé Nickel-plated Vernickelt		Hardheidsklasse 100HV Dureté 100HV Hardness 100HV Härte 100HV
	Koper Cuivre Copper Kupfer		Ral-gekleurd Couleur Ral Ral coloured Ral-farbig		Hardheidsklasse 140HV Dureté 140HV Hardness 140HV Härte 140HV
	Brons Bronzé Burnished Brüniert		CE-gecertificeerd Certifié CE CE certified CE-zertifiziert		Hardheidsklasse 200HV Dureté 200HV Hardness 200HV Härte 200HV



**HOUTBEVESTIGINGEN
FIXATIONS POUR LE BOIS
FASTENERS FOR WOOD
BEFESTIGUNGSMITTEL FÜR HOLZ**

CHIPBOARD SCREWS

GG10WP		16
GG20WP		17
GG30WP		18
GG00WP		18
GG10WP		20
GG20WP		20
GG30WP		21
GG00WP		21
GZ1TWP		21
GZ1TWP		22
GG1TWP		24
GG1TWP		23

WOOD SCREWS

GZ1571		25
GZ0571		26
GZ5571		27
GZ0A71		28
GZ0E71		28
GZ1603		28
GZ0603		29
GM1095		30
GM1096		31
GM1097		32
GN1095		33
GM0995		34
GN0995		34
GS0995		34
GB0995		34
GZ10WC		35
GZ00WC		36
GZ00DW		36
GZ11DW		37
GZ12DW		37
GZ01DW		38
GZ02DW		38

GZ08DW		38
GG0AWP		39
GZ1S-P		39
GZ2S-P		39
GZ0S-M		41
GZ0S-P		42
GZ1S-M		44
GZ0S-P		42

CAPS FOR SCREWS

GK10AF		45
GK20AF		45
GK00AF		46
GK30AF		46
GK10AF		46
GK10AF		47
GK1AF4		47
GZ0AFD		47

WOOD CONSTRUCTION SCREWS

GZ1TTG		48
GZ1VTG		49

PLASTERBOARD SCREWS





























































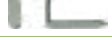







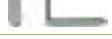

























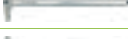











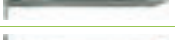



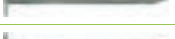



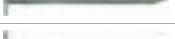



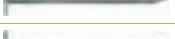



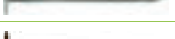



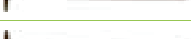

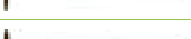



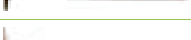

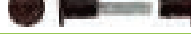



GP10GP		50
GP00GP		50

CLADDING SCREWS

GZ0L16		51
GZ00ER		51

HOOKS

GW10SO		52
GZ10SO		52
GZ00SO		53
GM10SO		53
GW10SD		53
GZ10SD		54
GZ00SD		54
GZ1ZSD		54
GM10SD		55

GW10SH			55	GZ50KR			68
GZ10SH			55	GZ1GYN			68
GZ00SH			56	GZ0GYN			69
GM10SH			56	GZ5GYN			69
GZ10WH			56	GZ10PN			69
NAILS							
GS1NPK			57	GS10BN			70
GS0NPK			57	GS00BN			70
GS1NRK			58	GZ1SNP			70
GS0NRK			59	GZ0SNP			71
GZ0NRK			60	GZ00RN			71
GM1NBK			60	GZ10PD			71
GM0NBK			60	GZ00PD			72
GT1NKK			61	GZ10BH			72
GT0NKK			61	GZ00BH			72
GT5NKK			61	GZ50BH			73
GT1NPK			62	GT1VKH			73
GT0NPK			62	GT0VKH			73
GT5NPK			63	GT1SHV			74
GS10GN			63	GT0SHV			74
GS00GN			63	GS1SZK			74
GS50GN			64	GZ0KLE			75
GZ0STN			64	GZ0NPK			75
GZ5STN			64	GK10PP			75
GZ1SNB			65	GM1DSP			76
GZ1SNE			65	GM1SIN			76
GZ0SNB			65	GM10KH			76
GZ0SNE			65	GM1XWH			77
GZ5SNB			66	GM1XWH			77
GZ5SNE			66	GM1ZKH			77
GM1SNE			66	FURNITURE FIXINGS			
GM0SNE			66	GK10PH			78
GM5SNE			67	GK1VSB			78
GM0SKR			67	GK1VSW			78
GZ10KR			67	GK1WPL			79
GZ00KR			68	GZ1ME3			79
				GK1ME1			79

SPAANPLAATSCHROEVEN
VIS AGGLO
CHIPBOARD SCREWS
SPANLATTENSCHRAUBE





GG10WP



Spaanderplaatschroef met verzonken kop
 Vis agglo à tête fraisée
 Chipboard screw with countersunk head
 Spanplattenschraube mit Senkkopf





d [mm]	l [mm]	Art. ref.	EAN code			Price code	Packaging
2,5	16	GG10WP025016	5410439553018	24	12	GA1	Blister A
2,5	20	GG10WP025020	5410439553025	24	12	GA1	Blister A
3	12	GG10WP030012	5410439553032	36	12	GA1	Blister A
3	16	GG10WP030016	5410439553049	32	12	GA1	Blister A
3	20	GG10WP030020	5410439553056	30	12	GA1	Blister A
3	25	GG10WP030025	5410439553063	21	12	GA1	Blister A
3	30	GG10WP030030	5410439553070	22	12	GA1	Blister A
3,5	16	GG10WP035016	5410439553100	27	12	GA1	Blister A
3,5	20	GG10WP035020	5410439553117	24	12	GA1	Blister A
3,5	25	GG10WP035025	5410439553124	21	12	GA1	Blister A
3,5	30	GG10WP035030	5410439553131	18	12	GA1	Blister A
3,5	40	GG10WP035040	5410439553155	14	12	GA1	Blister A
4	16	GG10WP040016	5410439553162	25	12	GA1	Blister A
4	20	GG10WP040020	5410439553179	20	12	GA1	Blister A
4	25	GG10WP040025	5410439553186	19	12	GA1	Blister A
4	30	GG10WP040030	5410439553193	17	12	GA1	Blister A
4	35	GG10WP040035	5410439553209	15	12	GA1	Blister A
4	40	GG10WP040040	5410439553216	12	12	GA1	Blister A
4	50	GG10WP040050	5410439553223	10	12	GA1	Blister A
4	60	GG10WP040060	5410439397858	5	12	GA1	Blister A
4,5	40	GG10WP045040	5410439553254	10	12	GA1	Blister A
4,5	50	GG10WP045050	5410439553261	8	12	GA1	Blister A
4,5	60	GG10WP045060	5410439553278	6	12	GA1	Blister A
5	50	GG10WP050050	5410439553308	6	12	GA1	Blister A
5	60	GG10WP050060	5410439553315	6	12	GA1	Blister A
5	70	GG10WP050070	5410439553322	5	12	GA1	Blister A
6	50	GG10WP060050	5410439553353	5	12	GA1	Blister A
6	60	GG10WP060060	5410439553360	3	12	GA1	Blister A
6	70	GG10WP060070	5410439120814	3	3	GA1	Blister E
6	80	GG10WP060080	5410439120821	2	3	GA1	Blister E

GG20WP



Spaanderplaatschroef met verzonken kop
 Vis agglo à tête fraisée
 Chipboard screw with countersunk head
 Spanplattenschraube mit Senkkopf



d [mm]	l [mm]	Art. ref.	EAN code			Price code	Packaging
2,5	12	GG20WP025012	5410439557009	100	12	GC1	Blister A
2,5	16	GG20WP025016	5410439557016	100	12	GD1	Blister A
3	16	GG20WP030016	5410439557047	100	12	GD1	Blister A
3	20	GG20WP030020	5410439557054	100	12	GD1	Blister A
3	25	GG20WP030025	5410439557061	100	6	GE1	Blister B
3	30	GG20WP030030	5410439557078	100	6	GF1	Blister B
3,5	16	GG20WP035016	5410439557115	100	6	GD1	Blister B
3,5	20	GG20WP035020	5410439557122	100	6	GE1	Blister B
3,5	25	GG20WP035025	5410439557139	100	6	GF1	Blister B
3,5	30	GG20WP035030	5410439557146	100	6	GF1	Blister B
3,5	40	GG20WP035040	5410439557160	75	6	GF1	Blister B
4	16	GG20WP040016	5410439557207	100	6	GF1	Blister B
4	20	GG20WP040020	5410439557214	100	6	GF1	Blister B
4	25	GG20WP040025	5410439557221	100	6	GF1	Blister B
4	30	GG20WP040030	5410439557238	90	6	GF1	Blister B
4	35	GG20WP040035	5410439557245	80	6	GF1	Blister B
4	40	GG20WP040040	5410439557252	65	6	GF1	Blister B
4	50	GG20WP040050	5410439557276	50	6	GF1	Blister B
4,5	16	GG20WP045016	5410439244060	90	6	GF1	Blister B
4,5	20	GG20WP045020	5410439244077	80	6	GF1	Blister B
4,5	25	GG20WP045025	5410439244084	75	6	GF1	Blister B
4,5	30	GG20WP045030	5410439123440	70	6	GF1	Blister B
4,5	40	GG20WP045040	5410439557344	50	6	GF1	Blister B
4,5	50	GG20WP045050	5410439557351	40	6	GF1	Blister B
4,5	60	GG20WP045060	5410439557368	35	6	GF1	Blister B
5	20	GG20WP050020	5410439244091	65	6	GF1	Blister B
5	25	GG20WP050025	5410439244107	60	6	GF1	Blister B
5	30	GG20WP050030	5410439557405	55	6	GF1	Blister B
5	40	GG20WP050040	5410439557429	45	6	GF1	Blister B
5	50	GG20WP050050	5410439557443	35	6	GF1	Blister B
5	60	GG20WP050060	5410439557450	30	6	GF1	Blister B
5	70	GG20WP050070	5410439120838	27	3	GG1	Blister E





GG30WP



Spaanderplaatschroef met verzonken kop
 Vis agglo à tête fraisée
 Chipboard screw with countersunk head
 Spanplattenschraube mit Senkkopf





d [mm]	l [mm]	Art. ref.	EAN code			Price code	Packaging
4	30	GG30WP040030	5410439123570	100	3	GH1	Blister E
4	35	GG30WP040035	5410439123587	100	3	GH3	Blister E
4	40	GG30WP040040	5410439110389	100	3	GH3	Blister E
4	45	GG30WP040045	5410439110396	100	3	GH3	Blister E
4	50	GG30WP040050	5410439110402	100	3	GJ1	Blister E
4,5	20	GG30WP045020	5410439123594	100	3	GH1	Blister E
4,5	25	GG30WP045025	5410439123600	100	3	GH1	Blister E
4,5	30	GG30WP045030	5410439123662	100	3	GH3	Blister E
4,5	35	GG30WP045035	5410439123679	100	3	GH3	Blister E
4,5	40	GG30WP045040	5410439123686	100	3	GJ1	Blister E
4,5	45	GG30WP045045	5410439123693	100	1	GJ1	Blister G
4,5	50	GG30WP045050	5410439123709	100	1	GK1	Blister G
4,5	60	GG30WP045060	5410439123716	100	1	GL1	Blister H
5	30	GG30WP050030	5410439123723	100	3	GJ1	Blister E
5	40	GG30WP050040	5410439123730	100	1	GK1	Blister G
5	45	GG30WP050045	5410439110518	100	1	GK1	Blister G
5	50	GG30WP050050	5410439123747	100	1	GK1	Blister H
5	60	GG30WP050060	5410439123754	100	1	GM1	Blister H
5	70	GG30WP050070	5410439123761	100	1	GN1	Blister H
6	50	GG30WP060050	5410439123785	100	1	GO1	Blister H
6	60	GG30WP060060	5410439123792	50	1	GK1	Blister G
6	70	GG30WP060070	5410439123808	50	1	GK1	Blister G

GG00WP

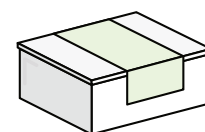

Spaanderplaatschroef met verzonken kop
 Vis agglo à tête fraisée
 Chipboard screw with countersunk head
 Spanplattenschraube mit Senkkopf



d [mm]	l [mm]	Art. ref.	EAN code			Price code	Packaging
2,5	12	GG00WP025012	5410439507004	200	3	GF1	Box 1A
2,5	16	GG00WP025016	5410439507011	200	3	GG1	Box 1A
2,5	20	GG00WP025020	5410439507028	200	3	GH1	Box 1A
3	12	GG00WP030012	5410439507035	200	3	GF1	Box 1A
3	16	GG00WP030016	5410439507042	200	3	GG1	Box 1A
3	20	GG00WP030020	5410439507059	200	3	GH1	Box 1A
3	25	GG00WP030025	5410439507066	200	3	GH1	Box 1A
3	30	GG00WP030030	5410439507073	200	3	GH3	Box 2A

GG00WP





Spaanderplaatschroef met verzonken kop

Vis agglo à tête fraisée

Chipboard screw with countersunk head

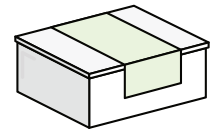
Spanplattenschraube mit Senkkopf



d [mm]	l [mm]	Art. ref.	EAN code			Price code	Packaging
3	35	GG00WP030035	5410439507080	200	3	GH3	Box 2A
3	40	GG00WP030040	5410439507097	200	3	GI1	Box 2A
3,5	12	GG00WP035012	5410439507103	200	3	GG1	Box 1A
3,5	16	GG00WP035016	5410439507110	200	3	GH1	Box 1A
3,5	20	GG00WP035020	5410439507127	200	3	GH1	Box 1A
3,5	25	GG00WP035025	5410439507134	200	3	GH3	Box 2A
3,5	30	GG00WP035030	5410439507141	200	3	GH3	Box 2A
3,5	35	GG00WP035035	5410439507158	200	3	GI1	Box 2A
3,5	40	GG00WP035040	5410439507165	200	1	GJ1	Box 3A
3,5	45	GG00WP035045	5410439507172	200	1	GK1	Box 4A
3,5	50	GG00WP035050	5410439507189	200	1	GK1	Box 4A
4	12	GG00WP040012	5410439507219	200	3	GH3	Box 1A
4	16	GG00WP040016	5410439507226	200	3	GH1	Box 1A
4	20	GG00WP040020	5410439507233	200	3	GH3	Box 1A
4	25	GG00WP040025	5410439507240	200	3	GH3	Box 2A
4	30	GG00WP040030	5410439507257	200	3	GI1	Box 2A
4	35	GG00WP040035	5410439507264	200	1	GJ1	Box 3A
4	40	GG00WP040040	5410439507271	200	1	GK1	Box 4A
4	45	GG00WP040045	5410439507288	200	1	GL1	Box 4A
4	50	GG00WP040050	5410439507295	200	1	GM1	Box 4A
4	60	GG00WP040060	5410439507318	200	1	GN1	Box 4A
4,5	16	GG00WP045016	5410439507363	200	3	GH3	Box 1A
4,5	20	GG00WP045020	5410439507370	200	3	GI1	Box 2A
4,5	25	GG00WP045025	5410439507387	200	3	GJ1	Box 2A
4,5	30	GG00WP045030	5410439507394	200	1	GK1	Box 3A
4,5	35	GG00WP045035	5410439507400	200	1	GK1	Box 3A
4,5	40	GG00WP045040	5410439507417	200	1	GL1	Box 4A
4,5	45	GG00WP045045	5410439507424	200	1	GM1	Box 4A
4,5	50	GG00WP045050	5410439507431	200	1	GN1	Box 4A
4,5	60	GG00WP045060	5410439507455	200	1	GP1	Box 5A
4,5	70	GG00WP045070	5410439507462	100	1	GL1	Box 4A
5	20	GG00WP050020	5410439507516	200	3	GJ1	Box 2A
5	25	GG00WP050025	5410439507523	200	3	GK1	Box 2A
5	30	GG00WP050030	5410439507530	200	1	GL1	Box 3A
5	35	GG00WP050035	5410439507547	200	1	GM1	Box 4A
5	40	GG00WP050040	5410439507554	200	1	GN1	Box 4A
5	45	GG00WP050045	5410439507561	200	1	GO1	Box 4A
5	50	GG00WP050050	5410439507578	200	1	GQ1	Box 5A
5	60	GG00WP050060	5410439507592	200	1	GR1	Box 5A
5	70	GG00WP050070	5410439507608	100	1	GM1	Box 4A





GG00WP

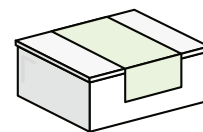

Spaanderplaatschroef met verzonken kop
 Vis agglo à tête fraisée
 Chipboard screw with countersunk head
 Spanplattenschraube mit Senkkopf





d [mm]	l [mm]	Art. ref.	EAN code			Price code	Packaging
6	40	GG00WP060040	5410439507653	200	1	GS1	Box 5A
6	45	GG00WP060045	5410439507660	200	1	GS1	Box 5A
6	50	GG00WP060050	5410439507677	100	1	GM1	Box 4A
6	60	GG00WP060060	5410439507691	100	1	GN1	Box 4A
6	70	GG00WP060070	5410439507707	100	1	GP1	Box 4A

GG10WP



Spaanderplaatschroef met verzonken kop
 Vis agglo à tête fraisée
 Chipboard screw with countersunk head
 Spanplattenschraube mit Senkkopf





d [mm]	l [mm]	Art. ref.	EAN code			Price code	Packaging
5	80	GG10WP050080	5410439120807	4	3	GA1	Blister E
5	100	GG10WP050100	5410439120456	3	3	GB1	Blister E

GG20WP



Spaanderplaatschroef met verzonken kop
 Vis agglo à tête fraisée
 Chipboard screw with countersunk head
 Spanplattenschraube mit Senkkopf



d [mm]	l [mm]	Art. ref.	EAN code			Price code	Packaging
5	80	GG20WP050080	5410439120845	23	3	GG1	Blister E
5	100	GG20WP050100	5410439124416	12	3	GG1	Blister E
6	50	GG20WP060050	5410439557528	20	6	GF1	Blister B
6	60	GG20WP060060	5410439557535	20	6	GF1	Blister B
6	70	GG20WP060070	5410439120852	20	3	GG1	Blister E
6	80	GG20WP060080	5410439120869	17	3	GG1	Blister E
6	100	GG20WP060100	5410439122146	12	3	GG1	Blister E
6	120	GG20WP060120	5410439120876	10	3	GG1	Blister E
6	140	GG20WP060140	5410439122191	5	1	GF1	Blister G
6	150	GG20WP060150	5410439122092	5	1	GG1	Blister G
6	160	GG20WP060160	5410439123365	5	1	GH1	Blister G

GG30WP



Spaanderplaatschroef met verzonken kop
 Vis agglo à tête fraisée
 Chipboard screw with countersunk head
 Spanplattenschraube mit Senkkopf

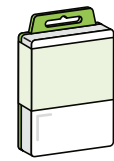

d [mm]	l [mm]	Art. ref.	EAN code			Price code	Packaging
5	80	GG30WP050080	5410439123778	100	1	GO1	Blister H
6	80	GG30WP060080	5410439123815	50	1	GK1	Blister H
6	90	GG30WP060090	5410439123822	50	1	GM1	Blister H
6	100	GG30WP060100	5410439123839	50	1	GO1	Blister H
6	120	GG30WP060120	5410439123846	50	1	GP1	Blister H
6	140	GG30WP060140	5410439123853	20	1	GK1	Blister G
6	150	GG30WP060150	5410439123877	20	1	GL1	Blister H
6	160	GG30WP060160	5410439123884	20	1	GN1	Blister H

GG00WP



Spaanderplaatschroef met verzonken kop
 Vis agglo à tête fraisée
 Chipboard screw with countersunk head
 Spanplattenschraube mit Senkkopf

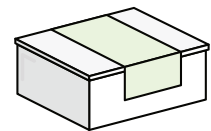

d [mm]	l [mm]	Art. ref.	EAN code			Price code	Packaging
5	80	GG00WP050080	5410439507615	100	1	GN1	Box 4A
5	90	GG00WP050090	5410439507622	100	1	GR1	Box 4A
5	100	GG00WP050100	5410439507639	100	1	GS1	Box 4A
6	80	GG00WP060080	5410439507714	100	1	GQ1	Box 4A
6	90	GG00WP060090	5410439507721	90	1	GS1	Box 5A
6	100	GG00WP060100	5410439507738	80	1	GS1	Box 5A
6	110	GG00WP060110	5410439507745	70	1	GS1	Box 4A
6	120	GG00WP060120	5410439507752	65	1	GS1	Box 4A

GZ1TWP



Spaanderplaatschroef PFS+ met verzonken kop
 Vis agglo PFS+ à tête fraisée
 Chipboard screw PFS+ with countersunk head
 Spanplattenschraube PFS+ mit Senkkopf

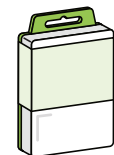

d [mm]	l [mm]	Art. ref.	EAN code			Price code	Packaging
3	12	GZ1TWP030012	5410439076050	40	12	GC1	Blister A
3	16	GZ1TWP030016	5410439076067	40	12	GC1	Blister A
3	20	GZ1TWP030020	5410439076074	40	12	GC1	Blister A
3,5	16	GZ1TWP035016	5410439076081	40	12	GC1	Blister A

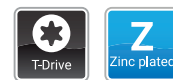

GZ1TWP



Spaanderplaatschroef PFS+ met verzonken kop
 Vis agglo PFS+ à tête fraisée
 Chipboard screw PFS+ with countersunk head
 Spanplattenschraube PFS+ mit Senkkopf



d [mm]	l [mm]	Art. ref.	EAN code			Price code	Packaging
3,5	20	GZ1TWP035020	5410439076098	40	12	GD1	Blister A
3,5	25	GZ1TWP035025	5410439076104	40	12	GD1	Blister A
3,5	30	GZ1TWP035030	5410439076111	40	12	GD1	Blister A
3,5	35	GZ1TWP035035	5410439076128	40	12	GD1	Blister A
3,5	50	GZ1TWP035050	5410439076135	25	12	GD1	Blister A
4	16	GZ1TWP040016	5410439076142	40	12	GC1	Blister A
4	20	GZ1TWP040020	5410439076159	40	12	GD1	Blister A
4	25	GZ1TWP040025	5410439076166	40	12	GD1	Blister A
4	30	GZ1TWP040030	5410439076173	40	12	GD1	Blister A
4	35	GZ1TWP040035	5410439076180	40	12	GD1	Blister A
4	40	GZ1TWP040040	5410439076197	25	12	GC1	Blister A
4,5	20	GZ1TWP045020	5410439076203	25	12	GC1	Blister A
4,5	25	GZ1TWP045025	5410439076210	25	12	GC1	Blister A
4,5	30	GZ1TWP045030	5410439076227	25	12	GC1	Blister A
4,5	35	GZ1TWP045035	5410439076234	25	12	GC1	Blister A
4,5	40	GZ1TWP045040	5410439076241	20	12	GC1	Blister A
5	25	GZ1TWP050025	5410439076258	20	12	GC1	Blister A
5	30	GZ1TWP050030	5410439076265	20	12	GC1	Blister A
5	40	GZ1TWP050040	5410439076272	25	6	GD1	Blister B
6	30	GZ1TWP060030	5410439076289	20	6	GD1	Blister B
6	40	GZ1TWP060040	5410439076296	20	6	GE1	Blister B
6	45	GZ1TWP060045	5410439076302	20	6	GF1	Blister B
6	50	GZ1TWP060050	5410439076319	20	6	GF1	Blister B
6	60	GZ1TWP060060	5410439076326	20	6	GG1	Blister B

GZ1TWP

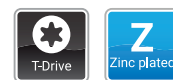

Spaanderplaatschroef PFS+ met verzonken kop
 Vis agglo PFS+ à tête fraisée
 Chipboard screw PFS+ with countersunk head
 Spanplattenschraube PFS+ mit Senkkopf



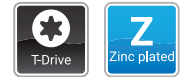

d [mm]	l [mm]	Art. ref.	EAN code			Price code	Packaging
3,5	40	GZ1TWP035040	5410439075817	25	12	GC1	Blister A
4	45	GZ1TWP040045	5410439075824	25	12	GD1	Blister A
4	50	GZ1TWP040050	5410439075831	25	12	GD1	Blister A
4	60	GZ1TWP040060	5410439075848	20	12	GD1	Blister A
4	70	GZ1TWP040070	5410439075855	20	12	GD1	Blister A
4,5	45	GZ1TWP045045	5410439075862	20	12	GC1	Blister A

GZ1TWP



Spaanderplaatschroef PFS+ met verzonken kop
 Vis agglo PFS+ à tête fraisée
 Chipboard screw PFS+ with countersunk head
 Spanplattenschraube PFS+ mit Senkkopf





d [mm]	l [mm]	Art. ref.	EAN code			Price code	Packaging
4,5	50	GZ1TWP045050	5410439075879	20	12	GD1	Blister A
4,5	60	GZ1TWP045060	5410439075886	25	6	GE1	Blister B
4,5	70	GZ1TWP045070	5410439075893	20	6	GE1	Blister B
4,5	80	GZ1TWP045080	5410439075909	10	6	GD1	Blister B
5	50	GZ1TWP050050	5410439075916	25	6	GE1	Blister B
5	60	GZ1TWP050060	5410439075923	25	6	GF1	Blister B
5	70	GZ1TWP050070	5410439075930	20	3	GH1	Blister E
5	80	GZ1TWP050080	5410439075947	20	3	GH3	Blister E
5	90	GZ1TWP050090	5410439075954	20	3	GI1	Blister E
5	100	GZ1TWP050100	5410439075961	20	3	GJ1	Blister E
5	120	GZ1TWP050120	5410439075978	20	3	GK1	Blister E
6	70	GZ1TWP060070	5410439075985	20	3	GH3	Blister E
6	80	GZ1TWP060080	5410439075992	10	3	GH1	Blister E
6	90	GZ1TWP060090	5410439076005	10	3	GG1	Blister E
6	100	GZ1TWP060100	5410439076012	10	3	GH1	Blister E
6	110	GZ1TWP060110	5410439076029	10	3	GH1	Blister E
6	120	GZ1TWP060120	5410439076036	10	3	GH3	Blister E
6	150	GZ1TWP060150	5410439076043	10	1	GK1	Blister G

GG1TWP

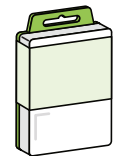

Spaanderplaatschroef PFS+ met verzonken kop
 Vis agglo PFS+ à tête fraisée
 Chipboard screw PFS+ with countersunk head
 Spanplattenschraube PFS+ mit Senkkopf



d [mm]	l [mm]	Art. ref.	EAN code			Price code	Packaging
5	80	GG1TWP050080	5410439122481	20	3	GH1	Blister E
5	90	GG1TWP050090	5410439122498	20	3	GH3	Blister E
5	100	GG1TWP050100	5410439122504	15	3	GH1	Blister E
6	60	GG1TWP060060	5410439122511	20	6	GH1	Blister B
6	80	GG1TWP060080	5410439122528	20	3	GH3	Blister E
6	90	GG1TWP060090	5410439122535	18	3	GH3	Blister E
6	100	GG1TWP060100	5410439122542	15	3	GH3	Blister E
6	120	GG1TWP060120	5410439122214	12	3	GH3	Blister E





GG1TWP



Spaanderplaatschroef PFS+ met verzonken kop
 Vis agglo PFS+ à tête fraisée
 Chipboard screw PFS+ with countersunk head
 Spanplattenschraube PFS+ mit Senkkopf



d [mm]	l [mm]	Art. ref.	EAN code			Price code	Packaging
3	16	GG1TWP030016	5410439122269	185	6	GH3	Blister B
3,5	16	GG1TWP035016	5410439122252	125	6	GG1	Blister B
3,5	25	GG1TWP035025	5410439122290	110	6	GH1	Blister B
3,5	30	GG1TWP035030	5410439122306	95	6	GH1	Blister B
3,5	35	GG1TWP035035	5410439122313	80	6	GG1	Blister B
3,5	40	GG1TWP035040	5410439122320	70	6	GG1	Blister B
4	16	GG1TWP040016	5410439122337	95	6	GG1	Blister B
4	20	GG1TWP040020	5410439122344	90	6	GG1	Blister B
4	25	GG1TWP040025	5410439122351	85	6	GG1	Blister B
4	30	GG1TWP040030	5410439122368	75	6	GG1	Blister B
4	40	GG1TWP040040	5410439122375	60	6	GG1	Blister B
4	50	GG1TWP040050	5410439122382	42	6	GF1	Blister B
4,5	40	GG1TWP045040	5410439122399	42	6	GF1	Blister B
4,5	45	GG1TWP045045	5410439122405	38	6	GF1	Blister B
4,5	50	GG1TWP045050	5410439122412	34	6	GF1	Blister B
4,5	60	GG1TWP045060	5410439122429	30	6	GG1	Blister B
5	25	GG1TWP050025	5410439122436	50	6	GF1	Blister B
5	30	GG1TWP050030	5410439122443	45	6	GF1	Blister B
5	40	GG1TWP050040	5410439122450	35	6	GF1	Blister B
5	50	GG1TWP050050	5410439122467	30	6	GF1	Blister B
5	60	GG1TWP050060	5410439122474	25	6	GF1	Blister B
3	20	GG1TWP030020	5410439122276	150	6	GH1	Blister B
3	25	GG1TWP030025	5410439122283	125	6	GH1	Blister B
3,5	20	GG1TWP035020	5410439110709	120	6	GH1	Blister B



HOUTSCHROEVEN
VIS À BOIS
WOOD SCREWS
HOLZSCHRAUBEN

GZ1571

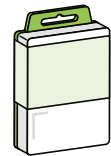

Houtdraadbout DIN 571
 Tirefond tête hexagonal DIN 571
 Hexagon coach screw DIN 571
 Sechskant-Holzschraube DIN 571



d [mm]	l [mm]	Art. ref.	EAN code			Price code	Packaging
5	40	GZ1571050040	5410439553674	14	6	GC1	Blister B
5	50	GZ1571050050	5410439553681	12	6	GC1	Blister B
5	60	GZ1571050060	5410439553698	8	6	GF1	Blister B
6	30	GZ1571060030	5410439553711	14	6	GC1	Blister B
6	40	GZ1571060040	5410439553728	12	6	GC1	Blister B
6	50	GZ1571060050	5410439553735	10	6	GC1	Blister B
6	60	GZ1571060060	5410439553742	9	6	GC1	Blister B
6	70	GZ1571060070	5410439553759	8	6	GC1	Blister B
6	80	GZ1571060080	5410439120975	12	3	GD1	Blister E
6	90	GZ1571060090	5410439120982	10	3	GD1	Blister E
6	100	GZ1571060100	5410439120999	10	3	GD1	Blister E
6	110	GZ1571060110	5410439121002	8	3	GD1	Blister E
6	120	GZ1571060120	5410439121019	6	3	GD1	Blister E
7	40	GZ1571070040	5410439402583	10	6	GD1	Blister B
7	50	GZ1571070050	5410439402590	10	6	GD1	Blister B
7	60	GZ1571070060	5410439403207	10	6	GD1	Blister B
7	70	GZ1571070070	5410439121026	10	3	GD1	Blister E
7	80	GZ1571070080	5410439121033	10	3	GE1	Blister E
7	90	GZ1571070090	5410439121040	10	3	GF1	Blister E
7	100	GZ1571070100	5410439121057	10	3	GE1	Blister E
7	110	GZ1571070110	5410439121064	10	3	GF1	Blister E
7	120	GZ1571070120	5410439121071	10	3	GF1	Blister E
8	30	GZ1571080030	5410439553810	10	6	GD1	Blister B
8	40	GZ1571080040	5410439553827	10	6	GD1	Blister B
8	50	GZ1571080050	5410439553834	8	6	GD1	Blister B
8	60	GZ1571080060	5410439553841	7	6	GD1	Blister B
8	70	GZ1571080070	5410439121088	6	3	GD1	Blister E
8	80	GZ1571080080	5410439121095	6	3	GE1	Blister E
8	90	GZ1571080090	5410439121101	8	3	GE1	Blister E
8	100	GZ1571080100	5410439121118	8	3	GG1	Blister E
8	110	GZ1571080110	5410439121125	8	3	GG1	Blister E
8	120	GZ1571080120	5410439121132	8	3	GG1	Blister E
10	50	GZ1571100050	5410439403306	5	6	GD1	Blister B



GZ1571



Houtdraadbout DIN 571
Tirefond tête hexagonal DIN 571
Hexagon coach screw DIN 571
Sechskant-Holzschraube DIN 571



d [mm]	l [mm]	Art. ref.	EAN code			Price code	Packaging
10	60	GZ1571100060	5410439403313	4	6	GD1	Blister B
10	70	GZ1571100070	5410439121149	8	3	GF1	Blister E
10	80	GZ1571100080	5410439121156	4	3	GD1	Blister E
10	90	GZ1571100090	5410439121163	4	3	GE1	Blister E
10	100	GZ1571100100	5410439121170	4	3	GE1	Blister E
10	120	GZ1571100120	5410439121187	4	3	GG1	Blister E
10	140	GZ1571100140	5410439121194	4	1	GH3	Blister G
10	160	GZ1571100160	5410439121200	4	1	GJ1	Blister H
10	180	GZ1571100180	5410439122160	4	1	GJ1	Blister H
10	200	GZ1571100200	5410439122177	4	1	GJ1	Blister H

GZ0571



Houtdraadbout DIN 571
Tirefond tête hexagonal DIN 571
Hexagon coach screw DIN 571
Sechskant-Holzschraube DIN 571

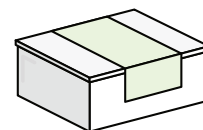

d [mm]	l [mm]	Art. ref.	EAN code			Price code	Packaging
5	40	GZ0571050040	5410439510950	50	3	GG1	Box 2A
5	50	GZ0571050050	5410439510967	50	3	GH1	Box 2A
5	60	GZ0571050060	5410439510974	50	3	GI1	Box 2A
6	30	GZ0571060030	5410439511018	50	3	GG1	Box 2A
6	40	GZ0571060040	5410439511025	50	3	GH1	Box 2A
6	50	GZ0571060050	5410439511032	50	1	GJ1	Box 4A
6	60	GZ0571060060	5410439511049	50	1	GI1	Box 4A
6	70	GZ0571060070	5410439511056	50	1	GJ1	Box 4A
6	80	GZ0571060080	5410439511063	50	1	GK1	Box 4A
6	90	GZ0571060090	5410439511070	50	1	GL1	Box 4A
6	100	GZ0571060100	5410439511087	25	1	GH3	Box 4A
6	110	GZ0571060110	5410439511094	25	1	GH3	Box 4A
6	120	GZ0571060120	5410439511100	25	1	GJ1	Box 4A
7	40	GZ0571070040	5410439511308	50	1	GJ1	Box 3A
7	50	GZ0571070050	5410439511315	50	1	GK1	Box 4A
7	60	GZ0571070060	5410439511322	50	1	GL1	Box 4A
7	70	GZ0571070070	5410439511339	50	1	GM1	Box 4A
7	80	GZ0571070080	5410439511346	50	1	GN1	Box 4A
7	90	GZ0571070090	5410439511353	50	1	GN1	Box 4A
7	100	GZ0571070100	5410439511360	25	1	GJ1	Box 4A



GZ0571



Houtdraadbout DIN 571
Tirefond tête hexagonal DIN 571
Hexagon coach screw DIN 571
Sechskant-Holzschraube DIN 571

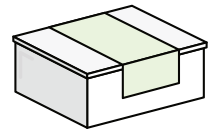

d [mm]	l [mm]	Art. ref.	EAN code			Price code	Packaging
7	110	GZ0571070110	5410439511377	25	1	GJ1	Box 4A
7	120	GZ0571070120	5410439511384	25	1	GK1	Box 4A
8	30	GZ0571080030	5410439511902	50	1	GK1	Box 4A
8	40	GZ0571080040	5410439511506	50	1	GK1	Box 4A
8	50	GZ0571080050	5410439511513	50	1	GL1	Box 4A
8	60	GZ0571080060	5410439511520	50	1	GL1	Box 4A
8	70	GZ0571080070	5410439511537	50	1	GO1	Box 4A
8	80	GZ0571080080	5410439511544	50	1	GQ1	Box 4A
8	90	GZ0571080090	5410439511551	50	1	GR1	Box 4A
8	100	GZ0571080100	5410439511568	25	1	GJ1	Box 4A
8	110	GZ0571080110	5410439511575	25	1	GM1	Box 4A
8	120	GZ0571080120	5410439511582	25	1	GL1	Box 4A
10	50	GZ0571100050	5410439511797	50	1	GQ1	Box 5A
10	60	GZ0571100060	5410439511803	50	1	GR1	Box 5A
10	70	GZ0571100070	5410439511810	25	1	GN1	Box 4A
10	80	GZ0571100080	5410439511827	25	1	GO1	Box 4A
10	90	GZ0571100090	5410439511834	25	1	GO1	Box 4A
10	100	GZ0571100100	5410439511841	25	1	GQ1	Box 4A
10	110	GZ0571100110	5410439511858	25	1	GQ1	Box 5A
10	120	GZ0571100120	5410439511865	25	1	GQ1	Box 5A

GZ5571



Houtdraadbout DIN 571
Tirefond tête hexagonal DIN 571
Hexagon coach screw DIN 571
Sechskant-Holzschraube DIN 571

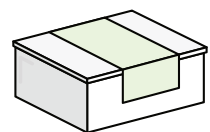

d [mm]	l [mm]	Art. ref.	EAN code			Price code	Packaging
6	40	GZ5571060040	5410439511216	100	1	GL1	Box 4A
6	50	GZ5571060050	5410439511223	100	1	GM1	Box 4A
6	60	GZ5571060060	5410439511230	100	1	GN1	Box 4A
6	80	GZ5571060080	5410439511247	100	1	GP1	Box 5B
7	110	GZ5571070110	5410439511391	50	1	GP1	Box 4A
8	40	GZ5571080040	5410439511605	100	1	GQ1	Box 5A
8	50	GZ5571080050	5410439511612	100	1	GS1	Box 5A
8	60	GZ5571080060	5410439511629	90	1	GS1	Box 5A



GZ0A71



Houtdraadbout DIN 571 & afdekkap
Tirefond DIN 571 & capuchon
Hexagon coach screw DIN 571 & cover cap
Sechskant-Holzschraube DIN 571 & Kombikappen

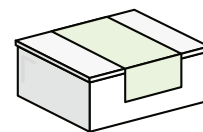

d [mm]	l [mm]	Art. ref.	EAN code			Price code	Packaging
7	90	GZ0A71070090	5410439510011	25	1	GL1	Box 5A
7	100	GZ0A71070100	5410439510028	25	1	GL1	Box 5A
7	110	GZ0A71070110	5410439510035	25	1	GL1	Box 5A

GZ0E71



Houtdraadbout DIN 571 & ermetic rondel
Tirefond DIN 571 & rondelle ermetic
Hexagon coach screw DIN 571 & bitumen washer
Sechskant-Holzschraube DIN 571 & Bitumen Scheibe

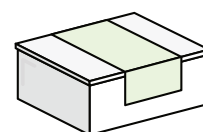

d [mm]	l [mm]	Art. ref.	EAN code			Price code	Packaging
7	70	GZ0E71070070	5410439510080	50	1	GP1	Box 5A
7	110	GZ0E71070110	5410439510097	50	1	GZ1	Box 5A

GZ1603



Houtbout DIN 603/555
Boulon à bois DIN 603/555
Carriage bolt DIN 603/555
Flachrundschrabe DIN 603/555



d [mm]	l [mm]	Art. ref.	EAN code			Price code	Packaging
M 5	25	GZ1603050025	5410439553940	12	6	GC1	Blister B
M 5	30	GZ1603050030	5410439553957	11	6	GC1	Blister B
M 5	40	GZ1603050040	5410439553964	9	6	GC1	Blister B
M 5	50	GZ1603050050	5410439553971	8	6	GC1	Blister B
M 5	60	GZ1603050060	5410439553988	8	6	GC1	Blister B
M 5	70	GZ1603050070	5410439553995	6	6	GC1	Blister B
M 6	20	GZ1603060020	5410439403399	11	6	GC1	Blister B
M 6	30	GZ1603060030	5410439403962	9	6	GC1	Blister B
M 6	40	GZ1603060040	5410439554022	7	6	GC1	Blister B
M 6	50	GZ1603060050	5410439554039	6	6	GC1	Blister B
M 6	60	GZ1603060060	5410439554046	5	6	GC1	Blister B
M 6	70	GZ1603060070	5410439121217	10	3	GE1	Blister E
M 6	80	GZ1603060080	5410439121224	8	3	GD1	Blister E
M 6	90	GZ1603060090	5410439121231	7	3	GD1	Blister E
M 6	100	GZ1603060100	5410439121248	6	3	GD1	Blister E



GZ1603



Houtbout DIN 603/555
 Boulon à bois DIN 603/555
 Carriage bolt DIN 603/555
 Flachrundschraube DIN 603/555



d [mm]	l [mm]	Art. ref.	EAN code			Price code	Packaging
M 6	110	GZ1603060110	5410439121255	6	3	GD1	Blister E
M 6	120	GZ1603060120	5410439121262	6	3	GD1	Blister E
M 8	30	GZ1603080030	5410439403382	7	6	GD1	Blister B
M 8	40	GZ1603080040	5410439554121	6	6	GD1	Blister B
M 8	50	GZ1603080050	5410439554138	5	6	GD1	Blister B
M 8	60	GZ1603080060	5410439554145	4	6	GD1	Blister B
M 8	70	GZ1603080070	5410439121279	6	3	GE1	Blister E
M 8	80	GZ1603080080	5410439121286	6	3	GF1	Blister E
M 8	90	GZ1603080090	5410439121293	5	3	GE1	Blister E
M 8	100	GZ1603080100	5410439121309	5	3	GE1	Blister E
M 8	120	GZ1603080120	5410439121316	5	3	GF1	Blister E
M 10	40	GZ1603100040	5410439403290	5	6	GD1	Blister B
M 10	50	GZ1603100050	5410439403900	4	6	GD1	Blister B
M 10	60	GZ1603100060	5410439403917	4	6	GE1	Blister B
M 10	70	GZ1603100070	5410439121323	8	1	GH1	Blister H
M 10	80	GZ1603100080	5410439121330	8	1	GH1	Blister H
M 10	90	GZ1603100090	5410439121347	8	1	GH1	Blister H
M 10	100	GZ1603100100	5410439121354	8	1	GH3	Blister H
M 10	120	GZ1603100120	5410439121361	4	1	GG1	Blister H
M 10	140	GZ1603100140	5410439121378	4	1	GJ1	Blister H
M 10	160	GZ1603100160	5410439121385	4	1	GH3	Blister H
M 10	180	GZ1603100180	5410439121392	4	1	GJ1	Blister H
M 10	200	GZ1603100200	5410439122139	4	1	GK1	Blister H

GZ0603



Houtbout DIN 603/555
 Boulon à bois DIN 603/555
 Carriage bolt DIN 603/555
 Flachrundschraube DIN 603/555

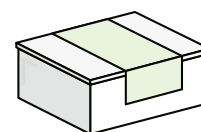

d [mm]	l [mm]	Art. ref.	EAN code			Price code	Packaging
M 5	25	GZ0603050025	5410439512503	50	3	GH1	Box 2A
M 5	30	GZ0603050030	5410439512510	50	3	GH3	Box 2A
M 5	40	GZ0603050040	5410439512527	50	3	GH3	Box 2A
M 5	50	GZ0603050050	5410439512534	50	3	GI1	Box 2A
M 5	60	GZ0603050060	5410439512541	50	1	GJ1	Box 3A
M 5	70	GZ0603050070	5410439512558	50	1	GJ1	Box 4A
M 6	20	GZ0603060020	5410439512602	50	3	GI1	Box 2A



GZ0603



Houtbout DIN 603/555
 Boulon à bois DIN 603/555
 Carriage bolt DIN 603/555
 Flachrundsraube DIN 603/555

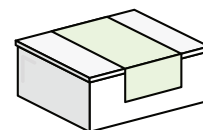

d [mm]	l [mm]	Art. ref.	EAN code			Price code	Packaging
M 6	30	GZ0603060030	5410439512619	50	1	GJ1	Box 3A
M 6	40	GZ0603060040	5410439512626	50	1	GJ1	Box 4A
M 6	50	GZ0603060050	5410439512633	50	1	GK1	Box 4A
M 6	60	GZ0603060060	5410439512640	50	1	GL1	Box 4A
M 6	70	GZ0603060070	5410439512657	50	1	GL1	Box 4A
M 6	80	GZ0603060080	5410439512664	50	1	GM1	Box 5A
M 6	90	GZ0603060090	5410439512671	25	1	GJ1	Box 4A
M 6	100	GZ0603060100	5410439512688	25	1	GJ1	Box 4A
M 6	110	GZ0603060110	5410439512695	25	1	GJ1	Box 4A
M 6	120	GZ0603060120	5410439512701	25	1	GK1	Box 4A
M 8	30	GZ0603080030	5410439512749	50	1	GO1	Box 4A
M 8	40	GZ0603080040	5410439512756	50	1	GP1	Box 4A
M 8	50	GZ0603080050	5410439512763	50	1	GQ1	Box 5A
M 8	60	GZ0603080060	5410439512770	50	1	GR1	Box 5A
M 8	70	GZ0603080070	5410439512787	50	1	GS1	Box 5A
M 8	80	GZ0603080080	5410439512794	45	1	GS1	Box 5A
M 8	90	GZ0603080090	5410439512800	25	1	GN1	Box 4A
M 8	100	GZ0603080100	5410439512817	25	1	GN1	Box 4A
M 8	120	GZ0603080120	5410439512831	25	1	GP1	Box 5A
M 10	40	GZ0603100040	5410439512862	25	1	GN1	Box 4A
M 10	50	GZ0603100050	5410439512879	25	1	GO1	Box 4A
M 10	60	GZ0603100060	5410439512886	25	1	GP1	Box 4A
M 10	70	GZ0603100070	5410439512893	25	1	GQ1	Box 5A
M 10	80	GZ0603100080	5410439512909	25	1	GR1	Box 5A
M 10	90	GZ0603100090	5410439512916	25	1	GS1	Box 5A
M 10	100	GZ0603100100	5410439512923	20	1	GQ1	Box 5A
M 10	120	GZ0603100120	5410439512947	15	1	GO1	Box 5A

GM1095



Houtschroef met bolle verzonken kop DIN 95
 Vis à bois à tête ronde fraisée DIN 95
 Wood screw with round countersunk head DIN 95
 Holzschraube mit Linsensenkopf DIN 95



d [mm]	l [mm]	Art. ref.	EAN code			Price code	Packaging
3	16	GM1095030016	5410439552028	20	12	GD1	Blister A
3	20	GM1095030020	5410439552035	19	12	GD1	Blister A
3	25	GM1095030025	5410439552042	16	12	GD1	Blister A





GM1095



Houtschroef met bolle verzonken kop DIN 95
 Vis à bois à tête ronde fraisée DIN 95
 Wood screw with round countersunk head DIN 95
 Holzschraube mit Linsensenkopf DIN 95





d [mm]	l [mm]	Art. ref.	EAN code			Price code	Packaging
3	30	GM1095030030	5410439552059	15	12	GD1	Blister A
3	35	GM1095030035	5410439552066	10	12	GD1	Blister A
3,5	16	GM1095035016	5410439552080	19	12	GD1	Blister A
3,5	20	GM1095035020	5410439552097	17	12	GD1	Blister A
3,5	25	GM1095035025	5410439552103	15	12	GD1	Blister A
3,5	30	GM1095035030	5410439552110	13	12	GD1	Blister A
3,5	40	GM1095035040	5410439552134	8	12	GD1	Blister A
4	25	GM1095040025	5410439552158	11	12	GD1	Blister A
4	30	GM1095040030	5410439552165	10	12	GD1	Blister A
4	35	GM1095040035	5410439552172	9	12	GD1	Blister A
4	40	GM1095040040	5410439552189	8	12	GD1	Blister A
4	45	GM1095040045	5410439552196	8	12	GD1	Blister A
4	50	GM1095040050	5410439552202	7	12	GE1	Blister A
5	30	GM1095050030	5410439552301	7	12	GE1	Blister A
5	40	GM1095050040	5410439552318	6	12	GE1	Blister A
5	50	GM1095050050	5410439552325	5	12	GE1	Blister A
5	60	GM1095050060	5410439552332	4	12	GE1	Blister A

GM1096



Houtschroef met ronde kop DIN 96
 Vis à bois à tête ronde DIN 96
 Wood screw with round head DIN 96
 Holzschraube mit Rundkopf DIN 96





d [mm]	l [mm]	Art. ref.	EAN code			Price code	Packaging
2,5	12	GM1096025012	5410439551403	17	12	GE1	Blister A
3	16	GM1096030016	5410439551427	17	12	GE1	Blister A
3	20	GM1096030020	5410439551434	17	12	GE1	Blister A
3	25	GM1096030025	5410439551441	15	12	GE1	Blister A
3	30	GM1096030030	5410439551601	13	12	GE1	Blister A
3,5	16	GM1096035016	5410439551618	16	12	GE1	Blister A
3,5	20	GM1096035020	5410439551458	15	12	GE1	Blister A
3,5	25	GM1096035025	5410439551465	13	12	GE1	Blister A
3,5	30	GM1096035030	5410439551472	13	12	GE1	Blister A
3,5	35	GM1096035035	5410439551489	10	12	GE1	Blister A
3,5	40	GM1096035040	5410439551496	8	12	GE1	Blister A
4	20	GM1096040020	5410439551502	11	12	GE1	Blister A
4	25	GM1096040025	5410439551519	9	12	GE1	Blister A

GM1096



Hout Schroef met ronde kop DIN 96
 Vis à bois à tête ronde DIN 96
 Wood screw with round head DIN 96
 Holzschraube mit Rundkopf DIN 96





d [mm]	l [mm]	Art. ref.	EAN code			Price code	Packaging
4	30	GM1096040030	5410439551526	8	12	GE1	Blister A
4	35	GM1096040035	5410439551533	8	12	GE1	Blister A
4	40	GM1096040040	5410439551540	7	12	GE1	Blister A
4	50	GM1096040050	5410439551649	5	12	GE1	Blister A
4,5	30	GM1096045030	5410439551557	6	12	GE1	Blister A
4,5	40	GM1096045040	5410439551564	5	12	GE1	Blister A
4,5	50	GM1096045050	5410439551571	4	12	GE1	Blister A
4,5	60	GM1096045060	5410439551588	4	12	GE1	Blister A
5	30	GM1096050030	5410439551656	6	12	GE1	Blister A
5	40	GM1096050040	5410439551663	5	12	GE1	Blister A
5	50	GM1096050050	5410439551670	4	12	GE1	Blister A
5	60	GM1096050060	5410439551687	4	12	GF1	Blister A

GM1097



Hout Schroef met verzonken platte kop DIN 97
 Vis à bois à tête plate fraisée DIN 97
 Wood screw with countersunk flat head DIN 97
 Holzschraube mit Senkkopf DIN 97



d [mm]	l [mm]	Art. ref.	EAN code			Price code	Packaging
2,5	12	GM1097025012	5410439551007	17	12	GD1	Blister A
3	16	GM1097030016	5410439551021	17	12	GD1	Blister A
3	20	GM1097030020	5410439551038	17	12	GD1	Blister A
3	25	GM1097030025	5410439551045	15	12	GD1	Blister A
3	30	GM1097030030	5410439551052	13	12	GD1	Blister A
3,5	16	GM1097035016	5410439404020	16	12	GD1	Blister A
3,5	20	GM1097035020	5410439551069	15	12	GD1	Blister A
3,5	25	GM1097035025	5410439551076	13	12	GD1	Blister A
3,5	30	GM1097035030	5410439551083	12	12	GD1	Blister A
3,5	35	GM1097035035	5410439551090	10	12	GD1	Blister A
3,5	40	GM1097035040	5410439551106	8	12	GD1	Blister A
4	20	GM1097040020	5410439551137	11	12	GD1	Blister A
4	25	GM1097040025	5410439551144	9	12	GD1	Blister A
4	30	GM1097040030	5410439551151	8	12	GD1	Blister A
4	35	GM1097040035	5410439551168	8	12	GD1	Blister A
4	40	GM1097040040	5410439551175	7	12	GD1	Blister A
4	50	GM1097040050	5410439551199	5	12	GD1	Blister A
4,5	30	GM1097045030	5410439551229	6	12	GD1	Blister A



GM1097





Houtschroef met verzonken platte kop DIN 97

Vis à bois à tête plate fraisée DIN 97

Wood screw with countersunk flat head DIN 97

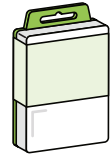
Holzschraube mit Senkkopf DIN 97



d [mm]	l [mm]	Art. ref.	EAN code			Price code	Packaging
4,5	40	GM1097045040	5410439551236	5	12	GD1	Blister A
4,5	50	GM1097045050	5410439551243	4	12	GD1	Blister A
4,5	60	GM1097045060	5410439551250	4	12	GD1	Blister A
5	30	GM1097050030	5410439551304	6	12	GD1	Blister A
5	40	GM1097050040	5410439551311	5	12	GD1	Blister A
5	50	GM1097050050	5410439551328	4	12	GD1	Blister A
5	60	GM1097050060	5410439551335	4	12	GD1	Blister A

GN1095





Houtschroef met bolle verzonken kop DIN 95

Vis à bois à tête ronde fraisée DIN 95

Wood screw with round countersunk head DIN 95

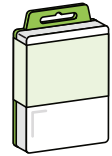
Holzschraube mit Linsensenkkopf DIN 95



d [mm]	l [mm]	Art. ref.	EAN code			Price code	Packaging
3	16	GN1095030016	5410439551700	18	12	GD1	Blister A
3	20	GN1095030020	5410439551717	16	12	GD1	Blister A
3	25	GN1095030025	5410439551724	14	12	GD1	Blister A
3,5	20	GN1095035020	5410439551755	14	12	GD1	Blister A
3,5	25	GN1095035025	5410439551731	12	12	GD1	Blister A
3,5	30	GN1095035030	5410439551762	10	12	GE1	Blister A
4	25	GN1095040025	5410439551809	10	12	GE1	Blister A
4	30	GN1095040030	5410439551816	9	12	GE1	Blister A
4	35	GN1095040035	5410439551823	9	12	GE1	Blister A
4	40	GN1095040040	5410439551830	9	12	GE1	Blister A
5	40	GN1095050040	5410439551908	5	12	GF1	Blister A
5	50	GN1095050050	5410439551915	4	12	GF1	Blister A
5	60	GN1095050060	5410439551922	4	12	GF1	Blister A



GM0995



Houtschroef DIN 7995Z
 Vis à bois DIN 7995Z
 Countersunk wood screw DIN 7995Z
 Spenglerschraube DIN 7995Z

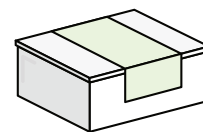

d [mm]	l [mm]	Art. ref.	EAN code			Price code	Packaging
4,5	45	GM0995045045	5410439343022	20	3	GH3	Box 1A
4,5	50	GM0995045050	5410439343039	20	3	GO1	Box 1A
4,5	60	GM0995045060	5410439343046	20	3	GR1	Box 1A



GN0995



Houtschroef DIN 7995Z
 Vis à bois DIN 7995Z
 Countersunk wood screw DIN 7995Z
 Spenglerschraube DIN 7995Z

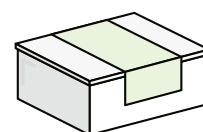

d [mm]	l [mm]	Art. ref.	EAN code			Price code	Packaging
4,5	45	GN0995045045	5410439342988	20	3	GI1	Box 1A
4,5	50	GN0995045050	5410439342995	20	3	GR1	Box 1A
4,5	60	GN0995045060	5410439343015	20	3	GR1	Box 1A



GS0995



Houtschroef DIN 7995Z
 Vis à bois DIN 7995Z
 Countersunk wood screw DIN 7995Z
 Spenglerschraube DIN 7995Z

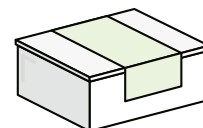

d [mm]	l [mm]	Art. ref.	EAN code			Price code	Packaging
4,5	45	GS0995045045	5410439343084	20	3	GK1	Box 1A
4,5	50	GS0995045050	5410439343091	20	3	GL1	Box 1A
4,5	60	GS0995045060	5410439343107	20	3	GK1	Box 1A



GB0995



Houtschroef DIN 7995Z
 Vis à bois DIN 7995Z
 Countersunk wood screw DIN 7995Z
 Spenglerschraube DIN 7995Z

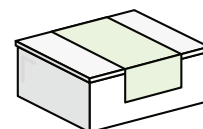

d [mm]	l [mm]	Art. ref.	EAN code			Price code	Packaging
4,5	45	GB0995045045	5410439343053	20	3	GJ1	Box 1A
4,5	50	GB0995045050	5410439343060	20	3	GK1	Box 1A



GB0995



Houtschroef DIN 7995Z
Vis à bois DIN 7995Z
Countersunk wood screw DIN 7995Z
Spenglerschraube DIN 7995Z

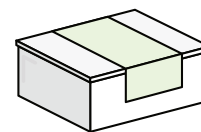



d [mm]	l [mm]	Art. ref.	EAN code			Price code	Packaging
4,5	60	GB0995045060	5410439343077	20	3	GM1	Box 1A

GZ10WC



Spaanderplaatschroef met halfronde kop
Vis aggio à tête cylindrique
Chipboard screw with panhead
Spanplattenschraube mit Zylinderkopf



d [mm]	l [mm]	Art. ref.	EAN code			Price code	Packaging
3	16	GZ10WC030016	5410439122825	36	12	GA1	Blister A
3	20	GZ10WC030020	5410439123051	32	12	GA1	Blister A
3	25	GZ10WC030025	5410439122832	30	12	GA1	Blister A
3,5	16	GZ10WC035016	5410439122849	24	12	GA1	Blister A
3,5	20	GZ10WC035020	5410439122856	24	12	GA1	Blister A
3,5	25	GZ10WC035025	5410439122863	22	12	GA1	Blister A
3,5	30	GZ10WC035030	5410439122870	20	12	GA1	Blister A
3,5	35	GZ10WC035035	5410439122887	18	12	GA1	Blister A
4	20	GZ10WC040020	5410439122894	22	12	GA1	Blister A
4	25	GZ10WC040025	5410439122900	20	12	GA1	Blister A
4	30	GZ10WC040030	5410439122917	18	12	GA1	Blister A
4	35	GZ10WC040035	5410439122924	15	12	GA1	Blister A
4	40	GZ10WC040040	5410439122931	13	12	GA1	Blister A
4	50	GZ10WC040050	5410439122948	9	12	GA1	Blister A
4,5	30	GZ10WC045030	5410439122955	12	12	GA1	Blister A
4,5	40	GZ10WC045040	5410439122962	10	12	GA1	Blister A
4,5	50	GZ10WC045050	5410439122979	9	12	GB1	Blister A
5	30	GZ10WC050030	5410439122993	10	12	GA1	Blister A
5	40	GZ10WC050040	5410439123006	9	12	GB1	Blister A
5	50	GZ10WC050050	5410439123013	8	12	GB1	Blister A
5	60	GZ10WC050060	5410439123020	6	12	GB1	Blister A
5	70	GZ10WC050070	5410439120906	5	12	GB1	Blister A
5	80	GZ10WC050080	5410439120913	5	3	GC1	Blister E
6	50	GZ10WC060050	5410439123037	6	12	GB1	Blister A
6	60	GZ10WC060060	5410439123044	5	12	GB1	Blister A
6	70	GZ10WC060070	5410439120920	4	3	GB1	Blister E
6	80	GZ10WC060080	5410439120937	4	3	GB1	Blister E





GZ00WC

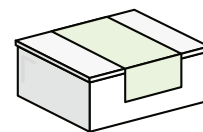

Spaanderplaatschroef met halfronde kop
 Vis agglo à tête cylindrique
 Chipboard screw with panhead
 Spanplattenschraube mit Zylinderkopf





d [mm]	l [mm]	Art. ref.	EAN code			Price code	Packaging
3	16	GZ00WC030016	5410439122580	200	3	GH3	Box 1A
3	20	GZ00WC030020	5410439122597	200	3	GH3	Box 1A
3	25	GZ00WC030025	5410439122603	200	3	GI1	Box 1A
3	30	GZ00WC030030	5410439122610	200	3	GK1	Box 2A
3,5	16	GZ00WC035016	5410439122627	200	3	GI1	Box 1A
3,5	20	GZ00WC035020	5410439122634	200	3	GJ1	Box 1A
3,5	25	GZ00WC035025	5410439122641	200	3	GK1	Box 1A
3,5	30	GZ00WC035030	5410439122658	200	3	GK1	Box 2A
3,5	35	GZ00WC035035	5410439122665	200	3	GN1	Box 2A
4	20	GZ00WC040020	5410439122672	200	3	GK1	Box 2A
4	25	GZ00WC040025	5410439122689	200	3	GK1	Box 2A
4	30	GZ00WC040030	5410439122696	200	3	GM1	Box 2A
4	35	GZ00WC040035	5410439122702	200	3	GN1	Box 2A
4	40	GZ00WC040040	5410439122719	200	1	GO1	Box 3A
4	50	GZ00WC040050	5410439122726	200	1	GQ1	Box 3A
4,5	30	GZ00WC045030	5410439122733	200	1	GN1	Box 3A
4,5	40	GZ00WC045040	5410439122740	200	1	GR1	Box 4A
4,5	50	GZ00WC045050	5410439122757	200	1	GU1	Box 4A
5	20	GZ00WC050020	5410439199049	200	3	GN1	Box 2A
5	30	GZ00WC050030	5410439122764	200	1	GQ1	Box 3A
5	35	GZ00WC050035	5410439122771	200	1	GT1	Box 3A
5	40	GZ00WC050040	5410439122788	200	1	GT1	Box 4A
5	50	GZ00WC050050	5410439122795	200	1	GW1	Box 5A
5	60	GZ00WC050060	5410439122801	200	1	GY1	Box 5A
5	70	GZ00WC050070	5410439369312	100	1	GR1	Box 4A
5	80	GZ00WC050080	5410439122818	100	1	GV1	Box 4A

GZ00DW

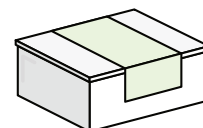

Schroef met kopboring
 Vis à panneaux à tête percée
 Chipboard screw with centre drill
 Spanplattenschraube mit Kopfbohrung



d [mm]	l [mm]	Art. ref.	EAN code			Price code	Packaging
4,5	20	GZ00DW045020	5410439338905	100	3	G01	Box 1A
4,5	25	GZ00DW045025	5410439338912	100	3	G01	Box 1A
4,5	30	GZ00DW045030	5410439338929	100	3	G01	Box 1A
4,5	35	GZ00DW045035	5410439338936	100	3	GP1	Box 2A

GZ00DW



Schroef met kopboring
 Vis à panneaux à tête percée
 Chipboard screw with centre drill
 Spanplattenschraube mit Kopfbohrung

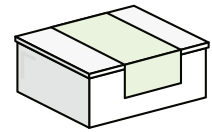

d [mm]	l [mm]	Art. ref.	EAN code			Price code	Packaging
4,5	40	GZ00DW045040	5410439338943	100	3	GQ1	Box 2A
4,5	45	GZ00DW045045	5410439338950	100	3	GQ1	Box 2A
4,5	50	GZ00DW045050	5410439338967	100	1	GR1	Box 3A
4,5	60	GZ00DW045060	5410439338974	100	1	GT1	Box 3A
4,5	70	GZ00DW045070	5410439338981	100	1	GV1	Box 4A
4,5	80	GZ00DW045080	5410439338998	100	1	GZ1	Box 4A

GZ11DW



Schroef met verzonken kop & witte afdekkap
 Vis à tête fraisée & capuchon blanc
 Screw with countersunk head & white cap
 Spanplattenschraube & Zierkap Weiss

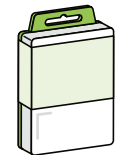

d [mm]	l [mm]	Art. ref.	EAN code			Price code	Packaging
4,5	30	GZ11DW045030	5410439552431	6	12	GB1	Blister A
4,5	35	GZ11DW045035	5410439552448	6	12	GB1	Blister A
4,5	40	GZ11DW045040	5410439552455	6	12	GB1	Blister A
4,5	45	GZ11DW045045	5410439552462	6	12	GB1	Blister A
4,5	50	GZ11DW045050	5410439552479	5	12	GB1	Blister A

GZ12DW



Schroef met verzonken kop & bruine afdekkap
 Vis à tête fraisée & capuchon brun
 Screw with countersunk head & brown cap
 Spanplattenschraube & Zierkap Braun

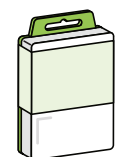

d [mm]	l [mm]	Art. ref.	EAN code			Price code	Packaging
4,5	30	GZ12DW045030	5410439552530	6	12	GB1	Blister A
4,5	35	GZ12DW045035	5410439552547	6	12	GB1	Blister A
4,5	40	GZ12DW045040	5410439552554	6	12	GB1	Blister A
4,5	45	GZ12DW045045	5410439552561	6	12	GB1	Blister A
4,5	50	GZ12DW045050	5410439552578	5	12	GB1	Blister A

GZ01DW



Schroef met verzonken kop & witte afdekkap
 Vis à tête fraisée & capuchon blanc
 Screw with countersunk head & white cap
 Splanlattenschraube & Zierkap Weiss

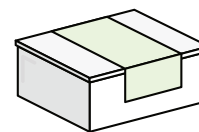

d [mm]	l [mm]	Art. ref.	EAN code			Price code	Packaging
4,5	20	GZ01DW045020	5410439504706	100	3	GP1	Box 2A
4,5	25	GZ01DW045025	5410439504713	100	3	GP1	Box 2A
4,5	30	GZ01DW045030	5410439504720	100	3	GQ1	Box 2A
4,5	35	GZ01DW045035	5410439504737	100	3	GR1	Box 2A
4,5	40	GZ01DW045040	5410439504744	100	1	GS1	Box 3A
4,5	45	GZ01DW045045	5410439504751	100	1	GS1	Box 3A
4,5	50	GZ01DW045050	5410439504768	90	1	GS1	Box 3A
4,5	60	GZ01DW045060	5410439128032	75	1	GS1	Box 3A



GZ02DW



Schroef met verzonken kop & bruine afdekkap
 Vis à tête fraisée & capuchon brun
 Screw with countersunk head & brown cap
 Splanlattenschraube & Zierkap Braun

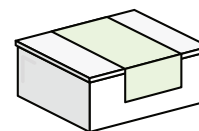

d [mm]	l [mm]	Art. ref.	EAN code			Price code	Packaging
4,5	20	GZ02DW045020	5410439504805	100	3	GP1	Box 2A
4,5	25	GZ02DW045025	5410439504812	100	3	GP1	Box 2A
4,5	30	GZ02DW045030	5410439504829	100	1	GQ1	Box 3A
4,5	35	GZ02DW045035	5410439504836	100	3	GR1	Box 2A
4,5	40	GZ02DW045040	5410439504843	100	1	GS1	Box 3A
4,5	45	GZ02DW045045	5410439504850	100	1	GS1	Box 3A
4,5	50	GZ02DW045050	5410439504867	90	1	GS1	Box 3A



GZ08DW



Schroef met verzonken kop & grijze afdekkap
 Vis à tête fraisée & capuchon gris
 Screw with countersunk head & grey cap
 Splanlattenschraube & Zierkap Gris

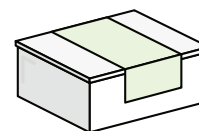

d [mm]	l [mm]	Art. ref.	EAN code			Price code	Packaging
4,5	30	GZ08DW045030	5410439147682	50	3	GJ1	Box 2A
4,5	40	GZ08DW045040	5410439147590	50	3	GJ1	Box 2A
4,5	45	GZ08DW045045	5410439147606	50	3	GJ1	Box 2A
4,5	50	GZ08DW045050	5410439147613	50	3	GJ1	Box 2A

GG0AWP



Houtschroef met verzonken kop & afdekkap
 Vis à bois à tête fraisée & capuchon
 Wood screw with countersunk head & cover cap
 Holzschraube & Kombikappen

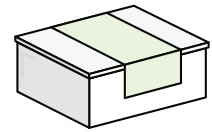

d [mm]	l [mm]	Art. ref.	EAN code			Price code	Packaging
5	50	GG0AWP050050	5410439510004	25	1	GH3	Box 4A

GZ1S-P



Houtschroef PFS+ met verzonken kop met groen glijmiddel
 Vis à bois à tête fraisée PFS+ avec lubrifiant vert
 Wood screw with countersunk head PFS+ with green lubricant
 Holzschraube mit Senkkopf PFS+ grün gefärbt

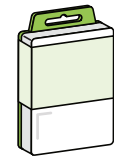

d [mm]	l [mm]	Art. ref.	EAN code			Price code	Packaging
3,5	16	GZ1S-P035016	5410439148221	12	12	GB1	Blister A
3,5	20	GZ1S-P035020	5410439148238	12	12	GB1	Blister A
3,5	25	GZ1S-P035025	5410439148245	12	12	GB1	Blister A
3,5	30	GZ1S-P035030	5410439148252	11	12	GB1	Blister A
3,5	35	GZ1S-P035035	5410439148269	11	12	GB1	Blister A
3,5	40	GZ1S-P035040	5410439148276	10	12	GB1	Blister A
4	20	GZ1S-P040020	5410439148283	10	12	GB1	Blister A
4	25	GZ1S-P040025	5410439148290	9	12	GB1	Blister A
4	30	GZ1S-P040030	5410439148306	9	12	GB1	Blister A
4	35	GZ1S-P040035	5410439148313	8	12	GB1	Blister A
4	40	GZ1S-P040040	5410439148320	7	12	GB1	Blister A
4	50	GZ1S-P040050	5410439148337	5	12	GB1	Blister A
4,5	30	GZ1S-P045030	5410439148344	7	12	GB1	Blister A
4,5	40	GZ1S-P045040	5410439148351	6	12	GB1	Blister A
4,5	50	GZ1S-P045050	5410439148368	5	12	GB1	Blister A
5	40	GZ1S-P050040	5410439148375	5	12	GB1	Blister A
5	50	GZ1S-P050050	5410439148382	5	12	GB1	Blister A

GZ2S-P



Houtschroef PFS+ met verzonken kop met groen glijmiddel
 Vis à bois à tête fraisée PFS+ avec lubrifiant vert
 Wood screw with countersunk head PFS+ with green lubricant
 Holzschraube mit Senkkopf PFS+ grün gefärbt



d [mm]	l [mm]	Art. ref.	EAN code			Price code	Packaging
3	16	GZ2S-P030016	5410439147781	100	12	GG1	Blister A
3	20	GZ2S-P030020	5410439147798	100	12	GG1	Blister A



GZ2S-P





Hout Schroef PFS+ met verzonken kop met groen glijmiddel

Vis à bois à tête fraisée PFS+ avec lubrifiant vert

Wood screw with countersunk head PFS+ with green lubricant

Holzschraube mit Senkkopf PFS+ grün gefärbt



d [mm]	l [mm]	Art. ref.	EAN code			Price code	Packaging
3	25	GZ2S-P030025	5410439147804	95	6	GH1	Blister B
3	30	GZ2S-P030030	5410439147811	95	6	GH1	Blister B
3	35	GZ2S-P030035	5410439149303	88	6	GH1	Blister B
3	40	GZ2S-P030040	5410439149310	78	6	GH1	Blister B
3,5	16	GZ2S-P035016	5410439147828	90	6	GG1	Blister B
3,5	20	GZ2S-P035020	5410439147835	100	6	GH1	Blister B
3,5	25	GZ2S-P035025	5410439147842	95	6	GH1	Blister B
3,5	30	GZ2S-P035030	5410439147859	85	6	GH1	Blister B
3,5	35	GZ2S-P035035	5410439147866	80	6	GH1	Blister B
3,5	40	GZ2S-P035040	5410439147873	70	6	GH1	Blister B
3,5	45	GZ2S-P035045	5410439149327	60	6	GH1	Blister B
3,5	50	GZ2S-P035050	5410439149334	53	6	GH1	Blister B
4	16	GZ2S-P040016	5410439147880	90	6	GH1	Blister B
4	20	GZ2S-P040020	5410439147897	85	6	GH1	Blister B
4	25	GZ2S-P040025	5410439148191	80	6	GH1	Blister B
4	30	GZ2S-P040030	5410439147903	75	6	GH1	Blister B
4	35	GZ2S-P040035	5410439147910	70	6	GH1	Blister B
4	40	GZ2S-P040040	5410439147927	58	6	GH1	Blister B
4	45	GZ2S-P040045	5410439147934	50	6	GH1	Blister B
4	50	GZ2S-P040050	5410439147941	45	6	GH1	Blister B
4	55	GZ2S-P040055	5410439149341	40	6	GH1	Blister B
4	60	GZ2S-P040060	5410439147958	37	6	GH1	Blister B
4	70	GZ2S-P040070	5410439149358	31	6	GH1	Blister B
4,5	20	GZ2S-P045020	5410439149365	75	6	GH1	Blister B
4,5	25	GZ2S-P045025	5410439147965	75	6	GH1	Blister B
4,5	30	GZ2S-P045030	5410439147972	63	6	GH1	Blister B
4,5	35	GZ2S-P045035	5410439147989	58	6	GH1	Blister B
4,5	40	GZ2S-P045040	5410439148207	50	6	GH1	Blister B
4,5	45	GZ2S-P045045	5410439147996	45	6	GH1	Blister B
4,5	50	GZ2S-P045050	5410439148009	40	6	GH1	Blister B
4,5	55	GZ2S-P045055	5410439149525	35	6	GH1	Blister B
4,5	60	GZ2S-P045060	5410439148016	33	6	GH1	Blister B
4,5	70	GZ2S-P045070	5410439149372	22	3	GH1	Blister E
4,5	80	GZ2S-P045080	5410439149389	17	3	GH1	Blister E
5	20	GZ2S-P050020	5410439149396	63	6	GH1	Blister B
5	25	GZ2S-P050025	5410439148023	58	6	GH1	Blister B
5	30	GZ2S-P050030	5410439148030	54	6	GH1	Blister B
5	35	GZ2S-P050035	5410439148214	47	6	GH1	Blister B
5	40	GZ2S-P050040	5410439148047	42	6	GH1	Blister B
5	45	GZ2S-P050045	5410439148054	37	6	GH1	Blister B

GZ2S-P





Hout Schroef PFS+ met verzonken kop met groen glijmiddel

Vis à bois à tête fraisée PFS+ avec lubrifiant vert

Wood screw with countersunk head PFS+ with green lubricant

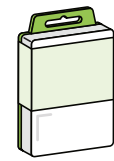
Holzschraube mit Senkkopf PFS+ grün gefärbt



d [mm]	l [mm]	Art. ref.	EAN code			Price code	Packaging
5	50	GZ2S-P050050	5410439148061	33	6	GH1	Blister B
5	55	GZ2S-P050055	5410439149464	30	6	GH1	Blister B
5	60	GZ2S-P050060	5410439148078	28	6	GH1	Blister B
5	70	GZ2S-P050070	5410439148085	24	3	GH1	Blister E
5	80	GZ2S-P050080	5410439148092	19	3	GH1	Blister E
5	90	GZ2S-P050090	5410439149402	13	3	GH3	Blister E
5	100	GZ2S-P050100	5410439148108	16	3	GH3	Blister E
6	30	GZ2S-P060030	5410439149280	30	6	GG1	Blister B
6	35	GZ2S-P060035	5410439149273	28	6	GG1	Blister B
6	40	GZ2S-P060040	5410439148115	25	6	GG1	Blister B
6	45	GZ2S-P060045	5410439149297	23	6	GG1	Blister B
6	50	GZ2S-P060050	5410439148122	20	6	GG1	Blister B
6	55	GZ2S-P060055	5410439149266	22	6	GH1	Blister B
6	60	GZ2S-P060060	5410439148139	19	6	GH1	Blister B
6	70	GZ2S-P060070	5410439148146	20	3	GH3	Blister E
6	80	GZ2S-P060080	5410439148153	17	3	GH3	Blister E
6	90	GZ2S-P060090	5410439149259	14	3	GH3	Blister E
6	100	GZ2S-P060100	5410439148160	12	3	GH3	Blister E
6	110	GZ2S-P060110	5410439148177	12	3	GI1	Blister E
6	120	GZ2S-P060120	5410439148184	11	3	GI1	Blister E
6	130	GZ2S-P060130	5410439149242	11	1	GJ1	Blister G
6	140	GZ2S-P060140	5410439149235	10	1	GJ1	Blister G
6	150	GZ2S-P060150	5410439149228	9	1	GJ1	Blister G
6	160	GZ2S-P060160	5410439149211	9	1	GK1	Blister G
6	180	GZ2S-P060180	5410439149204	8	1	GM1	Blister G
6	200	GZ2S-P060200	5410439149198	8	1	GO1	Blister G

GZ0S-M





MDF-schroef PFS+ met verzonken kop met groen glijmiddel

Vis pour MDF à tête fraisée PFS+ avec lubrifiant vert

MDF-screw with countersunk head PFS+ with green lubricant

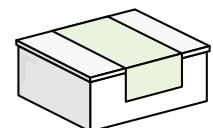
MDF-Schraube mit Senkkopf PFS+ grün gefärbt



d [mm]	l [mm]	Art. ref.	EAN code			Price code	Packaging
3,5	45	GZ0S-M035045	5410439149112	200	1	GQ1	Box 4A
3,5	50	GZ0S-M035050	5410439149129	200	1	GS1	Box 4A
4	40	GZ0S-M040040	5410439149136	200	1	GQ1	Box 4A
4	45	GZ0S-M040045	5410439149143	200	1	GR1	Box 4A





GZ0S-M

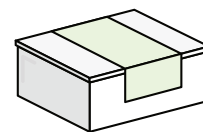

MDF-schroef PFS+ met verzonken kop met groen glijmiddel
 Vis pour MDF à tête fraisée PFS+ avec lubrifiant vert
 MDF-screw with countersunk head PFS+ with green lubricant
 MDF-Schraube mit Senkkopf PFS+ grün gefärbt





d [mm]	l [mm]	Art. ref.	EAN code			Price code	Packaging
4	50	GZ0S-M040050	5410439149150	200	1	GS1	Box 4A
4	60	GZ0S-M040060	5410439149167	200	1	GY1	Box 4A
4,5	45	GZ0S-M045045	5410439149174	200	1	GV1	Box 4A
4,5	50	GZ0S-M045050	5410439149181	200	1	GX1	Box 4A

GZ0S-P

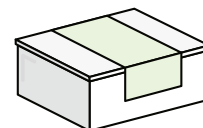

Houtschroef PFS+ met verzonken kop met groen glijmiddel
 Vis à bois à tête fraisée PFS+ avec lubrifiant vert
 Wood screw with countersunk head PFS+ with green lubricant
 Holzschraube mit Senkkopf PFS+ grün gefärbt



d [mm]	l [mm]	Art. ref.	EAN code			Price code	Packaging
3	16	GZ0S-P030016	5410439148405	200	3	GI1	Box 1A
3	20	GZ0S-P030020	5410439148399	200	3	GI1	Box 1A
3	25	GZ0S-P030025	5410439148429	200	3	GJ1	Box 1A
3	30	GZ0S-P030030	5410439148443	200	3	GK1	Box 2A
3	35	GZ0S-P030035	5410439148450	200	3	GK1	Box 2A
3	40	GZ0S-P030040	5410439148467	200	3	GL1	Box 2A
3,5	16	GZ0S-P035016	5410439148474	200	3	GJ1	Box 1A
3,5	20	GZ0S-P035020	5410439148481	200	3	GJ1	Box 1A
3,5	25	GZ0S-P035025	5410439148498	200	3	GK1	Box 2A
3,5	30	GZ0S-P035030	5410439148511	200	3	GK1	Box 2A
3,5	35	GZ0S-P035035	5410439148504	200	3	GL1	Box 2A
3,5	40	GZ0S-P035040	5410439148528	200	1	GM1	Box 3A
3,5	45	GZ0S-P035045	5410439148559	200	1	GO1	Box 4A
3,5	50	GZ0S-P035050	5410439148566	200	1	GP1	Box 4A
4	16	GZ0S-P040016	5410439148573	200	3	GK1	Box 1A
4	20	GZ0S-P040020	5410439148580	200	3	GK1	Box 1A
4	25	GZ0S-P040025	5410439148597	200	3	GL1	Box 2A
4	30	GZ0S-P040030	5410439148603	200	3	GL1	Box 2A
4	35	GZ0S-P040035	5410439148610	200	1	GM1	Box 3A
4	40	GZ0S-P040040	5410439148627	200	1	GN1	Box 3A
4	45	GZ0S-P040045	5410439148634	200	1	GO1	Box 4A
4	50	GZ0S-P040050	5410439148641	200	1	GR1	Box 4A
4	55	GZ0S-P040055	5410439148658	200	1	GT1	Box 5A
4	60	GZ0S-P040060	5410439148665	200	1	GU1	Box 5A
4	70	GZ0S-P040070	5410439148672	100	1	GO1	Box 4A
4,5	20	GZ0S-P045020	5410439148689	200	3	GL1	Box 2A

GZOS-P





Houtschroef PFS+ met verzonken kop met groen glijmiddel

Vis à bois à tête fraisée PFS+ avec lubrifiant vert

Wood screw with countersunk head PFS+ with green lubricant

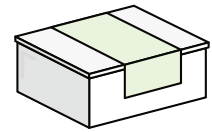
Holzschraube mit Senkkopf PFS+ grün gefärbt



d [mm]	l [mm]	Art. ref.	EAN code			Price code	Packaging
4,5	25	GZOS-P045025	5410439149471	200	3	GL1	Box 2A
4,5	30	GZOS-P045030	5410439148696	200	1	GN1	Box 3A
4,5	35	GZOS-P045035	5410439148702	200	1	GN1	Box 3A
4,5	40	GZOS-P045040	5410439148719	200	1	GP1	Box 4A
4,5	45	GZOS-P045045	5410439148726	200	1	GR1	Box 4A
4,5	50	GZOS-P045050	5410439148733	200	1	GT1	Box 5A
4,5	55	GZOS-P045055	5410439148740	200	1	GV1	Box 5A
4,5	60	GZOS-P045060	5410439148757	200	1	GW1	Box 5A
4,5	70	GZOS-P045070	5410439148764	100	1	GP1	Box 4A
4,5	80	GZOS-P045080	5410439148771	100	1	GS1	Box 4A
5	20	GZOS-P050020	5410439148788	200	3	GN1	Box 2A
5	25	GZOS-P050025	5410439148795	200	3	GO1	Box 2A
5	30	GZOS-P050030	5410439148801	200	1	GO1	Box 3A
5	35	GZOS-P050035	5410439148818	200	1	GR1	Box 4A
5	40	GZOS-P050040	5410439148825	200	1	GS1	Box 4A
5	45	GZOS-P050045	5410439148832	200	1	GU1	Box 4A
5	50	GZOS-P050050	5410439148849	200	1	GV1	Box 5A
5	55	GZOS-P050055	5410439148856	200	1	GX1	Box 5A
5	60	GZOS-P050060	5410439148863	200	1	GY1	Box 5A
5	70	GZOS-P050070	5410439148870	100	1	GQ1	Box 4A
5	80	GZOS-P050080	5410439148887	100	1	GT1	Box 4A
5	90	GZOS-P050090	5410439148894	80	1	GU1	Box 4A
5	100	GZOS-P050100	5410439148900	100	1	GY1	Box 4A
6	30	GZOS-P060030	5410439148917	100	1	GN1	Box 4A
6	35	GZOS-P060035	5410439148924	100	1	GN1	Box 4A
6	40	GZOS-P060040	5410439148931	100	1	GO1	Box 4A
6	45	GZOS-P060045	5410439148948	100	1	GP1	Box 4A
6	50	GZOS-P060050	5410439148955	100	1	GQ1	Box 4A
6	55	GZOS-P060055	5410439148962	100	1	GS1	Box 5A
6	60	GZOS-P060060	5410439148979	100	1	GT1	Box 5A
6	70	GZOS-P060070	5410439148986	100	1	GV1	Box 5A
6	80	GZOS-P060080	5410439148993	100	1	GX1	Box 5A
6	90	GZOS-P060090	5410439149006	80	1	GX1	Box 5A
6	100	GZOS-P060100	5410439149013	85	1	GZ1	Box 5A
6	110	GZOS-P060110	5410439149020	70	1	GZ1	Box 5A
6	120	GZOS-P060120	5410439149037	60	1	GZ1	Box 5A
6	130	GZOS-P060130	5410439149044	50	1	GZ1	Box 6B



GZ1S-M



MDF-schroef PFS+ met verzonken kop met groen glijmiddel
 Vis pour MDF à tête fraisée PFS+ avec lubrifiant vert
 MDF-screw with countersunk head PFS+ with green lubricant
 MDF-Schraube mit Senkkopf PFS+ grün gefärbt



d [mm]	l [mm]	Art. ref.	EAN code			Price code	Packaging
3,5	45	GZ1S-M035045	5410439147316	100	3	GK1	Blister E
3,5	50	GZ1S-M035050	5410439147323	100	3	GL1	Blister E
4	40	GZ1S-M040040	5410439147330	100	3	GK1	Blister E
4	45	GZ1S-M040045	5410439147347	100	3	GL1	Blister E
4	50	GZ1S-M040050	5410439147354	100	3	GL1	Blister E
4	60	GZ1S-M040060	5410439147361	80	3	GL1	Blister E
4,5	45	GZ1S-M045045	5410439147378	80	3	GK1	Blister E
4,5	50	GZ1S-M045050	5410439147385	80	3	GL1	Blister E

GZ0S-P



Houtschroef PFS+ met verzonken kop met groen glijmiddel
 Vis à bois à tête fraisée PFS+ avec lubrifiant vert
 Wood screw with countersunk head PFS+ with green lubricant
 Holzschraube mit Senkkopf PFS+ grün gefärbt

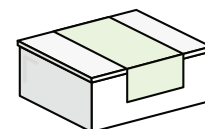

d [mm]	l [mm]	Art. ref.	EAN code			Price code	Packaging
6	140	GZ0S-P060140	5410439149051	45	1	GZ1	Box 6B
6	150	GZ0S-P060150	5410439149068	39	1	GZ1	Box 6B
6	160	GZ0S-P060160	5410439149075	36	1	GZ1	Box 6B
6	180	GZ0S-P060180	5410439149082	24	1	GZ1	Box 6B
6	200	GZ0S-P060200	5410439149099	18	1	GZ1	Box 6B

AFDEKKAPJES VOOR SCHROEVEN
 CAPOUCHONS POUR VIS
 CAPS FOR SCREWS
 ABDECKKAPPEN FÜR SCHRAUBEN

GK10AF_PIN



Afdekkapje met pin
 Cappuchon avec pointe
 Cap for screw with pin
 Zierkappen mit stift



d [mm]	l [mm]	Art. ref.	EAN code	Colour			Price code	Packaging
12	2,5	GK11AF010000	5410439175418	RAL 9010	30	12	GC1	Blister A
12	2,5	GK12AF010000	5410439175425	RAL 8011	30	12	GC1	Blister A
12	2,5	GK13AF010000	5410439175432	RAL 9005	30	12	GC1	Blister A
12	2,5	GK14AF010000	5410439175449	RAL 7001	30	12	GC1	Blister A
12	2,5	GK15AF010000	5410439175456	RAL 8001	30	12	GC1	Blister A
12	2,5	GK16AF010000	5410439241892	RAL 1001	30	12	GC1	Blister A
12	2,5	GK17AF010000	5410439241885	RAL 9001	30	12	GC1	Blister A
12	2,5	GK18AF010000	5410439241908	RAL 7016	30	12	GC1	Blister A
12	2,5	GK19AF010000	5410439241915	RAL 8016	30	12	GC1	Blister A

GK20AF



Afdekkapje met pin
 Cappuchon avec pointe
 Cap for screw with pin
 Zierkappen mit stift



d [mm]	l [mm]	Art. ref.	EAN code	Colour			Price code	Packaging
12	2,5	GK20AF010000	5410439241939	RAL 5011	30	12	GC1	Blister A
12	2,5	GK21AF010000	5410439241922	RAL 6009	30	12	GC1	Blister A
12	2,5	GK22AF010000	5410439241946	RAL 9016	30	12	GC1	Blister A
12	2,5	GK23AF010000	5410439241953	RAL 3004	30	12	GC1	Blister A



GK00AF



Afdekkapje met pin
Cappuchon avec pointe
Cap for screw with pin
Zierkappen mit stift

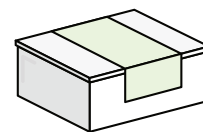

d [mm]	l [mm]	Art. ref.	EAN code	Colour			Price code	Packaging
12	2,5	GK01AF010000	5410439504904	RAL 9010	100	3	GH1	Box 1A
12	2,5	GK02AF010000	5410439504928	RAL 8011	100	3	GH1	Box 1A
12	2,5	GK03AF010000	5410439504911	RAL 9005	100	3	GH1	Box 1A
12	2,5	GK04AF010000	5410439504935	RAL 7001	100	3	GH1	Box 1A
12	2,5	GK05AF010000	5410439147675	RAL 8001	100	3	GH1	Box 1A
12	2,5	GK06AF010000	5410439242011	RAL 1001	100	3	GH1	Box 1A
12	2,5	GK07AF010000	5410439241977	RAL 9001	100	3	GH1	Box 1A
12	2,5	GK08AF010000	5410439242004	RAL 7016	100	3	GH1	Box 1A
12	2,5	GK09AF010000	5410439241991	RAL 8016	100	3	GH1	Box 1A

GK30AF



Afdekkapje met pin
Cappuchon avec pointe
Cap for screw with pin
Zierkappen mit stift

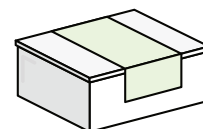

d [mm]	l [mm]	Art. ref.	EAN code	Colour			Price code	Packaging
12	2,5	GK30AF010000	5410439242028	RAL 5011	100	3	GH1	Box 1A
12	2,5	GK31AF010000	5410439242035	RAL 6009	100	3	GH1	Box 1A
12	2,5	GK32AF010000	5410439241984	RAL 9016	100	3	GH1	Box 1A
12	2,5	GK33AF010000	5410439242042	RAL 3004	100	3	GH1	Box 1A

GK10AF_PZ2



Afdekkapje voor schroef PZ2
Cappuchon pour vis PZ2
Cap for screw PZ2
Zierkappen für Schraube PZ2



d [mm]	l [mm]	Art. ref.	EAN code	Colour			Price code	Packaging
12	2,5	GK11AF020000	5410439553506	RAL 9010	30	12	GC1	Blister A
12	2,5	GK12AF020000	5410439553537	RAL 8011	30	12	GC1	Blister A
12	2,5	GK13AF020000	5410439553544	RAL 9005	30	12	GC1	Blister A
12	2,5	GK15AF020000	5410439553520	RAL 7001	30	12	GC1	Blister A
12	2,5	GK16AF020000	5410439553513	RAL 1001	30	12	GC1	Blister A



GK10AF_PZ3



Afdekkapje voor schroef PZ3
Cappuchon pour vis PZ3
Cap for screw PZ3
Zierkappen für Schraube PZ3

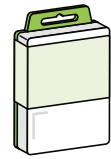

d [mm]	l [mm]	Art. ref.	EAN code	Colour			Price code	Packaging
12	2,5	GK11AF030000	5410439553605	RAL 9010	30	12	GD1	Blister A
12	2,5	GK12AF030000	5410439553636	RAL 8011	30	12	GD1	Blister A
12	2,5	GK13AF030000	5410439553643	RAL 9005	30	12	GD1	Blister A
12	2,5	GK15AF030000	5410439553629	RAL 7001	30	12	GD1	Blister A
12	2,5	GK16AF030000	5410439553612	RAL 1001	30	12	GD1	Blister A



GK1AF4



Afdekkap voor zeskant moer
Cache-écrou hexagonale
Cap for hexagon bolt & nut
Sechskantschutzkappe

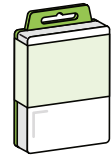

d [mm]	Art. ref.	EAN code			Price code	Packaging
M 6	GK1AF4060000	5410439074858	20	6	GD1	Blister B
M 8	GK1AF4080000	5410439074865	12	6	GD1	Blister B



GZ0AFD



Afdekkap voor houtdraadbout
Capuchon pour tirefond
Cover cap for hexagonal coach screw
Kombikappen für Sechskant Holzschraube

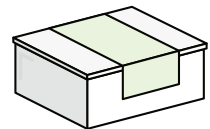

d [mm]	Art. ref.	EAN code			Price code	Packaging
5 mm	GZ0AFD050000	5410439510042	100	1	GN1	Box 5A
7 mm	GZ0AFD070000	5410439510059	50	1	GJ1	Box 5B

HOUTCONSTRUCTIESCHROEVEN
VIS POUR CONSTRUCTION À BOIS
WOOD CONSTRUCTION SCREWS
HOLZBAUSCHRAUBEN





GZ1TTG



Houtconstructieschroef met flenskop PFS+
 Vis pour construction en bois tête disque PFS+
 Wood construction screw with flange head PFS+
 Holzbauschraube mit Tellerkopf PFS+



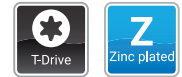

d [mm]	l [mm]	Art. ref.	EAN code			Price code	Packaging
6	30	GZ1TTG060030	5410439075398	10	6	GD1	Blister B
6	40	GZ1TTG060040	5410439075404	10	6	GD1	Blister B
6	50	GZ1TTG060050	5410439075411	10	6	GE1	Blister B
6	60	GZ1TTG060060	5410439075428	10	3	GF1	Blister E
6	70	GZ1TTG060070	5410439075435	10	3	GG1	Blister E
6	80	GZ1TTG060080	5410439075442	10	3	GH1	Blister E
6	100	GZ1TTG060100	5410439075459	10	3	GH3	Blister E
6	120	GZ1TTG060120	5410439075466	10	3	GJ1	Blister E
6	140	GZ1TTG060140	5410439075473	10	1	GK1	Blister G
6	160	GZ1TTG060160	5410439075480	10	1	GL1	Blister G
6	180	GZ1TTG060180	5410439075497	10	1	GM1	Blister G
6	200	GZ1TTG060200	5410439075503	10	1	GN1	Blister G
8	40	GZ1TTG080040	5410439075510	10	6	GH3	Blister B
8	50	GZ1TTG080050	5410439075527	10	3	GI1	Blister E
8	60	GZ1TTG080060	5410439075534	10	3	GJ1	Blister E
8	80	GZ1TTG080080	5410439075541	8	3	GJ1	Blister E
8	100	GZ1TTG080100	5410439075558	6	3	GJ1	Blister E
8	120	GZ1TTG080120	5410439075565	6	3	GK1	Blister E
8	140	GZ1TTG080140	5410439075572	6	1	GL1	Blister G
8	160	GZ1TTG080160	5410439075589	6	1	GM1	Blister G
8	180	GZ1TTG080180	5410439075596	6	1	GN1	Blister G
8	200	GZ1TTG080200	5410439075602	6	1	GO1	Blister G
10	100	GZ1TTG100100	5410439075619	6	1	GK1	Blister 2
10	120	GZ1TTG100120	5410439075626	6	1	GL1	Blister 2
10	140	GZ1TTG100140	5410439075633	6	1	GM1	Blister H
10	160	GZ1TTG100160	5410439075640	6	1	GN1	Blister H
10	180	GZ1TTG100180	5410439075657	6	1	GP1	Blister H
10	200	GZ1TTG100200	5410439075664	6	1	GR1	Blister H

GZ1VTG



Houtconstructieschroef met verzonken kop PFS+
 Vis à bois à tête fraisée PFS+
 Countersunk head wood screw PFS+
 Holzbauschraube Senkkopf PFS+



d [mm]	l [mm]	Art. ref.	EAN code			Price code	Packaging
6	80	GZ1VTG060080	5410439075671	10	3	GG1	Blister E
6	100	GZ1VTG060100	5410439075688	10	3	GH1	Blister E
6	120	GZ1VTG060120	5410439075695	10	3	GH3	Blister E
6	140	GZ1VTG060140	5410439075701	10	1	GJ1	Blister G
6	160	GZ1VTG060160	5410439075718	10	1	GK1	Blister G
6	180	GZ1VTG060180	5410439075725	10	1	GL1	Blister G
6	200	GZ1VTG060200	5410439075732	10	1	GM1	Blister G
8	80	GZ1VTG080080	5410439075749	10	3	GJ1	Blister E
8	100	GZ1VTG080100	5410439075756	10	3	GJ1	Blister E
8	120	GZ1VTG080120	5410439075763	10	3	GK1	Blister E
8	140	GZ1VTG080140	5410439075770	10	1	GL1	Blister G
8	160	GZ1VTG080160	5410439075787	10	1	GM1	Blister G
8	180	GZ1VTG080180	5410439075794	10	1	GN1	Blister G
8	200	GZ1VTG080200	5410439075800	10	1	GO1	Blister G

SNELBOUWSCHROEVEN
VIS À MONTAGE RAPIDE
DRYWALL SCREWS
SCHNELLBAUSCHRAUBE





GP10GP



Snelbouwschroef met fijne draad
 Vis à montage rapide à filetage fin
 Drywall screw with fine thread
 Schnellbauschraube mit Feingewinde



d [mm]	l [mm]	Art. ref.	EAN code			Price code	Packaging
3,5	25	GP10GP036025	5410439650014	30	12	GB1	Blister A
3,5	35	GP10GP036035	5410439650021	25	12	GB1	Blister A
3,5	45	GP10GP036045	5410439650038	20	12	GB1	Blister A
3,5	55	GP10GP039055	5410439650045	15	12	GB1	Blister A
4,2	65	GP10GP042065	5410439650052	12	12	GB1	Blister A





GP00GP

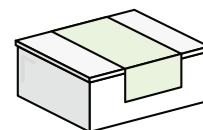

Snelbouwschroef met fijne draad
 Vis à montage rapide à filetage fin
 Drywall screw with fine thread
 Schnellbauschraube mit Feingewinde



d [mm]	l [mm]	Art. ref.	EAN code			Price code	Packaging
3,5	25	GP00GP036025	5410439600101	200	3	GI1	Box 2A
3,5	35	GP00GP036035	5410439600118	200	1	GJ1	Box 3A
3,5	45	GP00GP036045	5410439600125	200	1	GM1	Box 4A
3,5	55	GP00GP036055	5410439600132	200	1	GO1	Box 5A
4,2	65	GP00GP042065	5410439600149	100	1	GM1	Box 4A
4,2	75	GP00GP042075	5410439600156	100	1	GO1	Box 4A
4,2	85	GP00GP042085	5410439600163	100	1	GR1	Box 4A

GEVELSCHROEVEN
VIS DE BARDAGE
CLADDING SCREWS
FASSADENSCHRAUBEN

GZOL16



Zeskants gevelschroef
 Vis de bardage hexagonale
 Selftapping hexagon screw with flat collar
 Fassadenschraube mit Löffelspitze

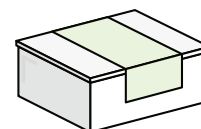

d [mm]	l [mm]	Art. ref.	EAN code			Price code	Packaging
6,5	19	GZOL16065019	5410439324847	20	3	GB1	Box 1A
6,5	25	GZOL16065025	5410439325097	20	3	GC1	Box 1A
6,5	32	GZOL16065032	5410439325103	20	3	GD1	Box 2A
6,5	38	GZOL16065038	5410439325110	20	3	GE1	Box 2A
6,5	50	GZOL16065050	5410439325127	20	3	GF1	Box 2A
6,5	75	GZOL16065075	5410439325134	20	3	GG1	Box 2A
6,5	90	GZOL16065090	5410439325141	20	1	GH1	Box 4A
6,5	115	GZOL16065115	5410439325158	20	1	GH3	Box 4A
6,5	64	GZOL16065064	5410439157506	20	3	GG1	Box 2A
6,5	130	GZOL16065130	5410439157513	20	1	GK1	Box 6B

GZ00ER



Rondel ERMETIC
 Rondelle ERMETIC
 Sealing washer with bitumen
 Scheibe mit Bitumen

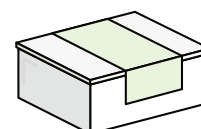

d [mm]	l [mm]	Art. ref.	EAN code			Price code	Packaging
9	22	GZ00ER090022	5410439510066	50	3	GI1	Box 1A
9	30	GZ00ER090030	5410439510073	30	3	GJ1	Box 2A

HAKEN
CROCHETS
HOOKS
HAKEN



GP
Plasticized

GW10SO



Schroefoog wit
Piton ordinaire blanc
Screw eye white
Schrauböse Weiss



d [mm]	l [mm]	Art. ref.	EAN code			Price code	Packaging
2,4	10	GW10SO025010	5410439555104	9	12	GC1	Blister A
3,2	16	GW10SO030016	5410439555111	6	12	GC1	Blister A
3,45	20	GW10SO035020	5410439555128	4	12	GC1	Blister A
4	30	GW10SO040030	5410439555135	3	12	GC1	Blister A
4,4	40	GW10SO050040	5410439555142	3	12	GC1	Blister A



Z
Zinc plated

GZ10SO

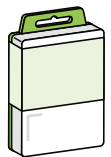

Schroefoog
Piton ordinaire
Screw eye
Schrauböse



d [mm]	l [mm]	Art. ref.	EAN code			Price code	Packaging
2,65	12	GZ10SO027512	5410439554503	18	12	GB1	Blister A
2,65	16	GZ10SO030016	5410439554510	12	12	GB1	Blister A
3,2	20	GZ10SO030020	5410439554527	8	12	GB1	Blister A
4	25	GZ10SO040025	5410439554534	6	12	GB1	Blister A
4	30	GZ10SO040030	5410439554541	6	12	GC1	Blister A
4,4	40	GZ10SO045040	5410439554558	5	12	GC1	Blister A
5,25	60	GZ10SO052560	5410439124775	4	3	GD1	Blister E
7	60	GZ10SO070060	5410439431774	4	3	GJ1	Blister E
7	100	GZ10SO070100	5410439431781	4	1	GK1	Blister G
7	140	GZ10SO070140	5410439431798	4	1	GK1	Blister G



GZ00SO



Schroefoog
Piton ordinaire
Screw eye
Schrauböse

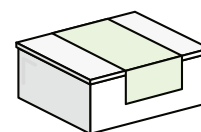

d [mm]	l [mm]	Art. ref.	EAN code			Price code	Packaging
2,15	12	GZ00SO027512	5410439554206	60	3	GH3	Box 1A
3,2	16	GZ00SO030016	5410439554213	40	3	GH3	Box 1A
3,2	20	GZ00SO030020	5410439554220	30	3	GH3	Box 1A
4	25	GZ00SO040025	5410439554237	24	3	GH3	Box 1A
4	30	GZ00SO040030	5410439554244	16	3	GH3	Box 1A
4,4	40	GZ00SO045040	5410439554251	10	3	GG1	Box 1A
5,25	60	GZ00SO052560	5410439554268	8	3	GI1	Box 1A

GM10SO



Schroefoog
Piton ordinaire
Screw eye
Schrauböse



d [mm]	l [mm]	Art. ref.	EAN code			Price code	Packaging
2,65	12	GM10SO022010	5410439575003	8	12	GF1	Blister A
2,5	12	GM10SO025012	5410439575010	5	12	GF1	Blister A
2,65	16	GM10SO027016	5410439575027	3	12	GF1	Blister A
3	20	GM10SO030020	5410439575034	3	12	GF1	Blister A
3,5	25	GM10SO035025	5410439575041	2	12	GF1	Blister A
4	30	GM10SO035030	5410439575058	2	12	GF1	Blister A

GW10SD



Schroefduim
Gonds à vis
Square hook
Gerade Schraubhaken



d [mm]	l [mm]	Art. ref.	EAN code			Price code	Packaging
2,4	25	GW10SD025025	5410439555302	7	12	GC1	Blister A
3,2	30	GW10SD030030	5410439555319	6	12	GC1	Blister A
3,2	40	GW10SD030040	5410439555326	4	12	GC1	Blister A
3,45	50	GW10SD035050	5410439555333	3	12	GC1	Blister A
4	60	GW10SD040060	5410439555340	2	12	GC1	Blister A



GZ10SD



Schroefduim
Gonds à vis
Square hook
Gerade Schraubhaken



d [mm]	l [mm]	Art. ref.	EAN code			Price code	Packaging
2,15	20	GZ10SD022520	5410439554701	18	12	GC1	Blister A
2,4	25	GZ10SD025025	5410439554718	16	12	GC1	Blister A
3,2	30	GZ10SD030030	5410439554725	13	12	GC1	Blister A
3,2	40	GZ10SD030040	5410439554732	8	12	GC1	Blister A
3,45	50	GZ10SD035050	5410439554749	6	12	GC1	Blister A
4	60	GZ10SD040060	5410439554756	5	12	GC1	Blister A
4,4	80	GZ10SD045080	5410439554763	4	12	GC1	Blister A

GZ00SD



Schroefduim
Gonds à vis
Square hook
Gerade Schraubhaken

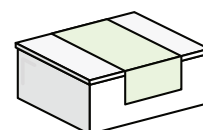

d [mm]	l [mm]	Art. ref.	EAN code			Price code	Packaging
2,15	20	GZ00SD022520	5410439554336	80	3	GH3	Box 1A
2,4	25	GZ00SD025025	5410439554343	70	3	GG1	Box 1A
3,2	30	GZ00SD030030	5410439554350	50	3	GH1	Box 1A
3,2	40	GZ00SD030040	5410439554367	27	3	GG1	Box 1A
3,45	50	GZ00SD035050	5410439554374	21	3	GG1	Box 1A
4	60	GZ00SD040060	5410439554381	14	3	GG1	Box 1A
4,4	80	GZ00SD045080	5410439554398	13	3	GG1	Box 1A

GZ1ZSD



Schroefduim met gleuf
Gonds à vis avec fente
Square hook type slotted
Schraubhaken mit Schlitz



d [mm]	l [mm]	Art. ref.	EAN code			Price code	Packaging
5,25	40	GZ1ZSD050040	5410439555029	4	12	GC1	Blister A
5,25	50	GZ1ZSD050050	5410439555036	3	12	GC1	Blister A
6	65	GZ1ZSD060065	5410439555043	4	12	GD1	Blister A
6	80	GZ1ZSD060080	5410439120883	4	3	GG1	Blister E





GM10SD



Schroefduim
Gonds à vis
Square hook
Gerade Schraubhaken





d [mm]	l [mm]	Art. ref.	EAN code			Price code	Packaging
2,15	20	GM10SD025020	5410439577007	7	12	GF1	Blister A
2,5	25	GM10SD025025	5410439577014	6	12	GF1	Blister A
3	30	GM10SD030030	5410439577021	5	12	GF1	Blister A
3,5	40	GM10SD035040	5410439577038	3	12	GF1	Blister A

GW10SH

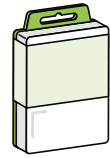

Schroefhaak
Crochet d'armoire
Cup hook
Gebogene Schraubhaken





d [mm]	l [mm]	Art. ref.	EAN code			Price code	Packaging
2,15	10	GW10SH022510	5410439555203	9	12	GC1	Blister A
2,4	16	GW10SH025016	5410439555210	6	12	GC1	Blister A
3,2	20	GW10SH030020	5410439555227	4	12	GC1	Blister A
3,45	30	GW10SH035030	5410439555234	3	12	GC1	Blister A

GZ10SH



Schroefhaak
Crochet d'armoire
Cup hook
Gebogene Schraubhaken



d [mm]	l [mm]	Art. ref.	EAN code			Price code	Packaging
2,4	12	GZ10SH024012	5410439554602	18	12	GD1	Blister A
2,4	16	GZ10SH025016	5410439554619	12	12	GC1	Blister A
3,2	20	GZ10SH030020	5410439554626	8	12	GC1	Blister A
3,45	30	GZ10SH035030	5410439554633	6	12	GC1	Blister A
4,4	30	GZ10SH045030	5410439554640	6	12	GC1	Blister A
5	40	GZ10SH050040	5410439554657	5	6	GC1	Blister B
5	50	GZ10SH050050	5410439120890	4	3	GD1	Blister E



GZ00SH



Schroefhaak
Crochet d'armoire
Cup hook
Gebogene Schraubhaken

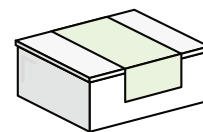

d [mm]	l [mm]	Art. ref.	EAN code			Price code	Packaging
2,4	12	GZ00SH024012	5410439554275	60	3	GG1	Box 1A
2,4	16	GZ00SH025016	5410439554282	40	3	GG1	Box 1A
3,2	20	GZ00SH030020	5410439554299	25	3	GG1	Box 1A
3,45	30	GZ00SH035030	5410439554305	21	3	GG1	Box 1A
4,4	30	GZ00SH045030	5410439554312	15	3	GG1	Box 1A
4,4	50	GZ00SH045050	5410439554329	10	3	GH3	Box 1A



GM10SH



Schroefhaak
Crochet d'armoire
Cup hook
Gebogene Schraubhaken



d [mm]	l [mm]	Art. ref.	EAN code			Price code	Packaging
2,25	10	GM10SH022010	5410439576000	7	12	GB1	Blister A
2,5	12	GM10SH025012	5410439576017	5	12	GE1	Blister A
3	16	GM10SH030016	5410439576024	3	12	GE1	Blister A
3	20	GM10SH030020	5410439576031	2	12	GE1	Blister A
3,5	30	GM10SH035030	5410439576055	2	12	GE1	Blister A



GZ10WH



Windhaak
Crochet contre vent
Gate hook
Sturmhaken



d [mm]	l [mm]	Art. ref.	EAN code			Price code	Packaging
3,5	50	GZ10WH035050	5410439554909	2	12	GE1	Blister A
3,5	60	GZ10WH035060	5410439554916	2	12	GE1	Blister A
4	80	GZ10WH040080	5410439120944	4	3	GH3	Blister E
4	100	GZ10WH040100	5410439120951	4	3	GH3	Blister E
4,5	120	GZ10WH045120	5410439120968	4	3	GI1	Blister E



NAGELS
POINTES
NAILS
STIFTEN

GS1NPK



Construotionegel DIN 1151B
Pointe de construction DIN 1151B
Construction nail DIN 1151B
Flachkopfstifte DIN 1151B





d [mm]	l [mm]	Art. ref.	EAN code			Price code	Packaging
1	15	GS1NPK010015	5410439450010	100 g	6	GB1	Blister B
1,2	20	GS1NPK012020	5410439450027	120 g	6	GB1	Blister B
1,5	25	GS1NPK015025	5410439450034	140 g	6	GB1	Blister B
1,8	30	GS1NPK018030	5410439450041	160 g	6	GB1	Blister B
2	35	GS1NPK020035	5410439450058	180 g	6	GB1	Blister B
2	40	GS1NPK020040	5410439450065	180 g	6	GB1	Blister B
2,2	45	GS1NPK022045	5410439450072	220 g	6	GB1	Blister B
2,7	50	GS1NPK027050	5410439450089	220 g	6	GB1	Blister B
2,7	55	GS1NPK027055	5410439450096	220 g	6	GB1	Blister B
2,7	60	GS1NPK027060	5410439450102	220 g	6	GB1	Blister B
3	65	GS1NPK030065	5410439450119	220 g	6	GB1	Blister B
3,5	70	GS1NPK035070	5410439450126	220 g	6	GB1	Blister B
3,5	80	GS1NPK035080	5410439121446	220 g	3	GB1	Blister E
4	90	GS1NPK040090	5410439121453	220 g	3	GB1	Blister E
4	100	GS1NPK045100	5410439121460	220 g	3	GB1	Blister E
5	110	GS1NPK050110	5410439121477	220 g	3	GB1	Blister E
5	125	GS1NPK050120	5410439121484	220 g	3	GB1	Blister E
5	140	GS1NPK050140	5410439123457	500 g	1	GH1	Blister G
5,5	150	GS1NPK055150	5410439123464	500 g	1	GH1	Blister G
6	160	GS1NPK060160	5410439123471	600 g	1	GH1	Blister G
6,5	180	GS1NPK065180	5410439123488	500 g	1	GH1	Blister G
7	200	GS1NPK070200	5410439123495	500 g	1	GH1	Blister G

GS0NPK

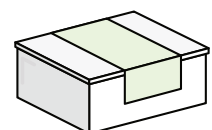

Construotionegel DIN 1151B
Pointe de construction DIN 1151B
Construction nail DIN 1151B
Flachkopfstifte DIN 1151B



d [mm]	l [mm]	Art. ref.	EAN code			Price code	Packaging
1	15	GS0NPK010015	5410439400015	300 g	3	GH1	Box 2A





GS0NPK

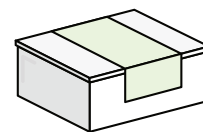

Constructienagel DIN 1151B
 Pointe de construction DIN 1151B
 Construction nail DIN 1151B
 Flachkopfstifte DIN 1151B





d [mm]	l [mm]	Art. ref.	EAN code			Price code	Packaging
1,2	20	GS0NPK012020	5410439400022	400 g	3	GH1	Box 2A
1,5	25	GS0NPK015025	5410439400039	425 g	3	GH1	Box 2A
1,8	30	GS0NPK018030	5410439400046	470 g	1	GH1	Box 3A
2	35	GS0NPK020035	5410439400053	550 g	1	GH1	Box 3A
2	40	GS0NPK020040	5410439400060	600 g	1	GH1	Box 4A
2,2	45	GS0NPK022045	5410439400077	650 g	1	GH1	Box 4A
2,7	50	GS0NPK027050	5410439400084	700 g	1	GH1	Box 4A
2,7	55	GS0NPK027055	5410439400091	725 g	1	GH1	Box 4A
2,7	60	GS0NPK027060	5410439400107	725 g	1	GH1	Box 4A
3	65	GS0NPK030065	5410439400114	750 g	1	GH1	Box 4A
3,5	70	GS0NPK035070	5410439400121	750 g	1	GH1	Box 4A
3,5	80	GS0NPK035080	5410439400138	750 g	1	GH1	Box 4A
4	90	GS0NPK040090	5410439400145	750 g	1	GH1	Box 4A
4	100	GS0NPK045100	5410439400152	750 g	1	GH1	Box 4A
5	110	GS0NPK050110	5410439400169	750 g	1	GH1	Box 4A
5	125	GS0NPK050120	5410439400176	750 g	1	GH1	Box 4A
5,5	140	GS0NPK055140	5410439307598	1000 g	1	GI1	Box 6B
5,5	150	GS0NPK055150	5410439401005	1000 g	1	GI1	Box 6B
6	160	GS0NPK060160	5410439401012	1000 g	1	GI1	Box 6B
6,5	180	GS0NPK065180	5410439401029	1000 g	1	GI1	Box 6B
7	200	GS0NPK070200	5410439401036	1000 g	1	GI1	Box 6B

GS1NRK



Nagel met ronde kop DIN 1152
 Pointe à tête ronde DIN 1152
 Finishing nail DIN 1152
 Stauchkopfstifte rund DIN 1152



d [mm]	l [mm]	Art. ref.	EAN code			Price code	Packaging
1	15	GS1NRK010015	5410439450201	100 g	6	GB1	Blister B
1,2	20	GS1NRK012020	5410439450218	120 g	6	GB1	Blister B
1,5	25	GS1NRK015025	5410439450225	140 g	6	GB1	Blister B
1,8	30	GS1NRK018030	5410439450232	160 g	6	GB1	Blister B
2	35	GS1NRK020035	5410439450249	180 g	6	GB1	Blister B
2	40	GS1NRK020040	5410439450256	180 g	6	GB1	Blister B
2,2	45	GS1NRK022045	5410439450263	200 g	6	GB1	Blister B
2,7	50	GS1NRK027050	5410439450270	220 g	6	GB1	Blister B
2,7	55	GS1NRK027055	5410439450287	220 g	6	GB1	Blister B



GS1NRK





Nagel met ronde kop DIN 1152

Pointe à tête ronde DIN 1152

Finishing nail DIN 1152

Stauchkopfstifte rund DIN 1152



d [mm]	l [mm]	Art. ref.	EAN code			Price code	Packaging
2,7	60	GS1NRK027060	5410439450294	220 g	6	GB1	Blister B
3	65	GS1NRK030065	5410439450300	220 g	6	GB1	Blister B
3,5	70	GS1NRK035070	5410439450317	220 g	6	GB1	Blister B
3,5	80	GS1NRK035080	5410439121491	220 g	3	GB1	Blister E
4	90	GS1NRK040090	5410439121507	220 g	3	GB1	Blister E
4	100	GS1NRK045100	5410439121514	220 g	3	GB1	Blister E
5	110	GS1NRK050110	5410439121521	220 g	3	GB1	Blister E
5	125	GS1NRK050120	5410439121538	220 g	3	GB1	Blister E

GS0NRK





Nagel met ronde kop DIN 1169

Pointe à tête ronde DIN 1152

Finishing nail DIN 1152

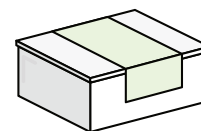
Stauchkopfstifte rund DIN 1152



d [mm]	l [mm]	Art. ref.	EAN code			Price code	Packaging
1	15	GS0NRK010015	5410439400305	300 g	3	GH1	Box 2A
1,2	20	GS0NRK012020	5410439400312	400 g	3	GH1	Box 2A
1,5	25	GS0NRK015025	5410439400329	425 g	3	GH1	Box 2A
1,8	30	GS0NRK018030	5410439400336	470 g	1	GH1	Box 3A
2	35	GS0NRK020035	5410439400343	550 g	1	GH1	Box 3A
2	40	GS0NRK020040	5410439400350	600 g	1	GH1	Box 4A
2,2	45	GS0NRK022045	5410439400367	650 g	1	GH1	Box 4A
2,7	50	GS0NRK027050	5410439400374	700 g	1	GH1	Box 4A
2,7	55	GS0NRK027055	5410439400381	725 g	1	GH1	Box 4A
2,7	60	GS0NRK027060	5410439400398	725 g	1	GH1	Box 4A
3	65	GS0NRK030065	5410439400404	750 g	1	GH1	Box 4A
3,5	70	GS0NRK035070	5410439400411	750 g	1	GH1	Box 4A
3,5	80	GS0NRK035080	5410439400428	750 g	1	GH1	Box 4A
4	90	GS0NRK040090	5410439400435	750 g	1	GH1	Box 4A
4	100	GS0NRK045100	5410439400442	750 g	1	GH1	Box 4A
5	110	GS0NRK050110	5410439400459	750 g	1	GH1	Box 4A
5	125	GS0NRK050120	5410439400466	750 g	1	GH1	Box 4A
5	140	GS0NRK050140	5410439400473	1000 g	1	GI1	Box 6B
5,5	150	GS0NRK055150	5410439123860	1000 g	1	GI1	Box 6B



GZ0NRK



Nagel met ronde kop DIN 1188
Pointe à tête ronde DIN 1152
Finishing nail DIN 1152
Stauchkopfstifte rund DIN 1152

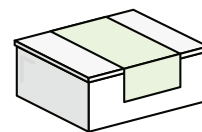

d [mm]	l [mm]	Art. ref.	EAN code			Price code	Packaging
1	15	GZ0NRK010015	5410439670722	300 g	3	GK1	Box 2A
1,2	20	GZ0NRK012020	5410439670739	400 g	3	GK1	Box 2A
1,5	25	GZ0NRK015025	5410439670746	425 g	3	GK1	Box 2A
1,8	30	GZ0NRK018030	5410439670753	470 g	3	GK1	Box 2A
2	35	GZ0NRK020035	5410439670760	550 g	1	GK1	Box 3A
2	40	GZ0NRK020040	5410439670777	600 g	1	GK1	Box 3A
2,2	45	GZ0NRK022045	5410439670784	650 g	1	GK1	Box 3A
2,7	50	GZ0NRK027050	5410439670791	700 g	1	GK1	Box 3A
2,7	55	GZ0NRK027055	5410439670807	725 g	1	GL1	Box 3A
2,7	60	GZ0NRK027060	5410439670814	725 g	1	GL1	Box 3A

GM1NBK



Nagel met bolkop
Pointe tete ronde
Finishing nail
Halbrundkopf Nägel



d [mm]	l [mm]	Art. ref.	EAN code			Price code	Packaging
1,5	15	GM1NBK015015	5410439451109	30 g	12	GD1	Blister A
1,5	20	GM1NBK015020	5410439451116	30 g	12	GD1	Blister A
1,8	25	GM1NBK018025	5410439451123	30 g	12	GD1	Blister A
1,8	30	GM1NBK018030	5410439451130	30 g	12	GD1	Blister A

GM0NBK



Nagel met bolkop
Pointe tete ronde
Finishing nail
Halbrundkopf Nägel

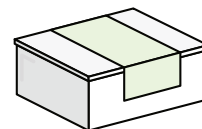

d [mm]	l [mm]	Art. ref.	EAN code			Price code	Packaging
1,5	15	GM0NBK015015	5410439670821	150 g	3	GT1	Box 1A
1,5	20	GM0NBK015020	5410439670838	150 g	3	GT1	Box 1A
1,8	30	GM0NBK018030	5410439670845	150 g	3	GT1	Box 1A





GT1NKK

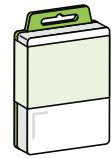

Nagel met bolle verzonken kop
 Pointe à tête convexe
 Masonry nail with convex head
 Konvexkopfstifte





d [mm]	l [mm]	Art. ref.	EAN code			Price code	Packaging
2	25	GT1NKK020025	5410439386517	70 g	12	GC1	Blister A
2,4	30	GT1NKK024030	5410439386524	70 g	12	GC1	Blister A
3	40	GT1NKK030040	5410439386531	90 g	12	GC1	Blister A
3	50	GT1NKK030050	5410439386548	90 g	12	GC1	Blister A
3,5	60	GT1NKK035060	5410439386555	90 g	12	GC1	Blister A
3,5	70	GT1NKK035070	5410439386562	90 g	12	GC1	Blister A

GT0NKK

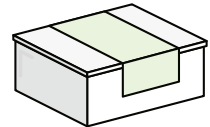

Nagel met bolle verzonken kop
 Pointe à tête convexe
 Masonry nail with convex head
 Konvexkopfstifte





d [mm]	l [mm]	Art. ref.	EAN code			Price code	Packaging
2	20	GT0NKK020020	5410439386432	200 g	3	GH3	Box 1A
2	25	GT0NKK020025	5410439386449	200 g	3	GH3	Box 1A
2,4	30	GT0NKK024030	5410439386456	200 g	3	GH3	Box 1A
3	40	GT0NKK030040	5410439386463	250 g	3	GH3	Box 1A
3	50	GT0NKK030050	5410439386470	275 g	3	GH3	Box 1A
3,5	60	GT0NKK035060	5410439386487	275 g	3	GH3	Box 1A
3,5	70	GT0NKK035070	5410439386494	275 g	3	GH3	Box 2A
3,5	80	GT0NKK035080	5410439386500	275 g	3	GH3	Box 1A

GT5NKK

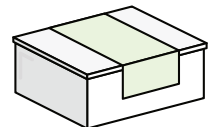

Nagel met bolle verzonken kop
 Pointe à tête convexe
 Masonry nail with convex head
 Konvexkopfstifte



d [mm]	l [mm]	Art. ref.	EAN code			Price code	Packaging
2	20	GT5NKK020020	5410439386579	700 g	1	GS1	Box 4A
2	25	GT5NKK020025	5410439386586	800 g	1	GS1	Box 4A
2,4	30	GT5NKK024030	5410439386593	850 g	1	GS1	Box 4A
3	40	GT5NKK030040	5410439386609	900 g	1	GS1	Box 4A
3	50	GT5NKK030050	5410439386616	900 g	1	GS1	Box 4A
3,5	60	GT5NKK035060	5410439386623	900 g	1	GS1	Box 4A





GT5NKK

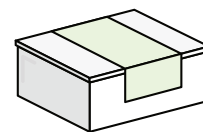

Nagel met bolle verzonken kop
Pointe à tête convexe
Masonry nail with convex head
Konvexkopfstifte





d [mm]	l [mm]	Art. ref.	EAN code			Price code	Packaging
3,5	70	GT5NKK035070	5410439386630	900 g	1	GS1	Box 4A
3,5	80	GT5NKK035080	5410439386647	900 g	1	GS1	Box 4A

GT1NPK



Nagel met platte verzonken kop
Pointe à tête fraisée plate
Masonry nail with countersunk head
Senkkopfstifte





d [mm]	l [mm]	Art. ref.	EAN code			Price code	Packaging
2	25	GT1NPK020025	5410439386739	70 g	12	GC1	Blister A
2,4	30	GT1NPK024030	5410439386746	70 g	12	GC1	Blister A
3	40	GT1NPK030040	5410439386753	90 g	12	GC1	Blister A
3	50	GT1NPK030050	5410439386760	90 g	12	GC1	Blister A
3,5	60	GT1NPK035060	5410439386777	90 g	12	GC1	Blister A
3,5	70	GT1NPK035070	5410439386784	90 g	12	GC1	Blister A

GT0NPK

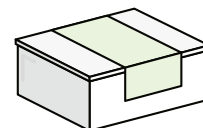

Nagel met platte verzonken kop
Pointe à tête fraisée plate
Masonry nail with countersunk head
Senkkopfstifte



d [mm]	l [mm]	Art. ref.	EAN code			Price code	Packaging
2	20	GT0NPK020020	5410439386654	200 g	3	GH3	Box 1A
2	25	GT0NPK020025	5410439386661	200 g	3	GH3	Box 1A
2,4	30	GT0NPK024030	5410439386678	200 g	3	GH3	Box 1A
3	40	GT0NPK030040	5410439386685	250 g	3	GH3	Box 2A
3	50	GT0NPK030050	5410439386692	275 g	3	GH3	Box 2A
3,5	60	GT0NPK035060	5410439386708	275 g	3	GH3	Box 1A
3,5	70	GT0NPK035070	5410439386715	275 g	3	GH3	Box 1A
3,5	80	GT0NPK035080	5410439386722	275 g	3	GH3	Box 2A



GT5NPK



Nagel met platte verzonken kop
 Pointe à tête fraisée plate
 Masonry nail with countersunk head
 Senkkopfstifte

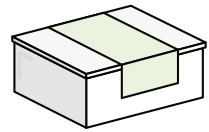

d [mm]	l [mm]	Art. ref.	EAN code			Price code	Packaging
2	20	GT5NPK020020	5410439386791	700 g	1	GS1	Box 4A
2	25	GT5NPK020025	5410439386807	800 g	1	GS1	Box 4A
2,4	30	GT5NPK024030	5410439386814	850 g	1	GS1	Box 4A
3	40	GT5NPK030040	5410439386821	900 g	1	GS1	Box 4A
3	50	GT5NPK030050	5410439386838	900 g	1	GS1	Box 4A
3,5	60	GT5NPK035060	5410439386845	900 g	1	GS1	Box 4A
3,5	70	GT5NPK035070	5410439386852	900 g	1	GS1	Box 4A
3,5	80	GT5NPK035080	5410439386869	900 g	1	GS1	Box 4A

GS10GN



Getorste nagel
 Pointe torsadées en fer
 Screw nail
 Schraubenägel

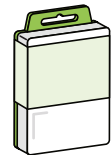

d [mm]	l [mm]	Art. ref.	EAN code			Price code	Packaging
3	50	GS10GN030050	5410439450706	125 g	6	GB1	Blister B
3	60	GS10GN030060	5410439450713	125 g	6	GB1	Blister B
3,5	65	GS10GN030070	5410439450720	125 g	6	GB1	Blister B
3,5	80	GS10GN030080	5410439121545	125 g	3	GB1	Blister E

GS00GN



Getorste nagel
 Pointe torsadées en fer
 Screw nail
 Schraubenägel

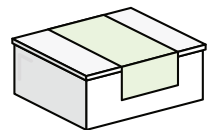

d [mm]	l [mm]	Art. ref.	EAN code			Price code	Packaging
3	50	GS00GN030050	5410439401807	370 g	3	GH1	Box 2A
3	60	GS00GN030060	5410439401814	370 g	3	GH1	Box 2A
3,5	65	GS00GN030070	5410439401821	370 g	3	GH1	Box 2A
3,5	80	GS00GN030080	5410439401838	370 g	3	GH1	Box 2A



GS50GN



Getorste nagel
Pointe torsadées en fer
Screw nail
Schraubenägel

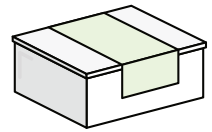

d [mm]	l [mm]	Art. ref.	EAN code			Price code	Packaging
3	50	GS50GN030050	5410439401845	1000 g	1	GO1	Box 5A
3	60	GS50GN030060	5410439401852	1000 g	1	GO1	Box 5A
3,5	65	GS50GN030070	5410439401869	1000 g	1	GO1	Box 5A
3,5	80	GS50GN030080	5410439401876	1000 g	1	GO1	Box 4A

GZ0STN



Stormnagel ronde kop
Pointe à tête embase ronde
Light board nail round
Leichtbauplattenstift

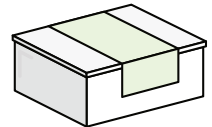

d [mm]	l [mm]	Art. ref.	EAN code			Price code	Packaging
3,5	50	GZ0STN031050	5410439401708	340 g	1	GI1	Box 4A
3,1	60	GZ0STN031060	5410439401715	340 g	1	GI1	Box 4A
3,5	70	GZ0STN031070	5410439401722	340 g	1	GI1	Box 4A
3,4	80	GZ0STN031080	5410439401739	340 g	1	GI1	Box 4A

GZ5STN



Stormnagel ronde kop
Pointe à tête embase ronde
Light board nail round
Leichtbauplattenstift

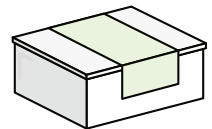

d [mm]	l [mm]	Art. ref.	EAN code			Price code	Packaging
3,5	50	GZ5STN031050	5410439401746	500 g	1	GL1	Box 4A
3,1	60	GZ5STN031060	5410439401753	500 g	1	GL1	Box 5A
3,5	70	GZ5STN031070	5410439401760	500 g	1	GL1	Box 5A
3,4	80	GZ5STN031080	5410439401777	500 g	1	GL1	Box 5A



GZ1SNB



Schalienagel met brede kop DIN 1160A
 Pointe d'ardoise à tête large DIN 1160A
 Roofing nail with large head DIN 1160A
 Schieferstifte DIN 1160A

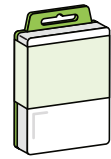

d [mm]	l [mm]	Art. ref.	EAN code			Price code	Packaging
2,7	30	GZ1SNB027030	5410439650212	100 g	6	GB1	Blister B
3	25	GZ1SNB030025	5410439650205	100 g	6	GB1	Blister B

GZ1SNE



Schalienagel met extra brede kop DIN 1160B
 Pointe d'ardoise à tête extra large DIN 1160B
 Roofing nail with extra large head DIN 1160B
 Schieferstifte DIN 1160B



d [mm]	l [mm]	Art. ref.	EAN code			Price code	Packaging
3	15	GZ1SNE030015	5410439484770	100 g	6	GC1	Blister B
3	20	GZ1SNE030020	5410439650304	100 g	6	GC1	Blister B
3	25	GZ1SNE030025	5410439650311	100 g	6	GC1	Blister B
3	40	GZ1SNE030040	5410439650328	100 g	6	GC1	Blister B

GZOSNB



Schalienagel met brede kop DIN 1160A
 Pointe d'ardoise à tête large DIN 1160A
 Roofing nail with large head DIN 1160A
 Schieferstifte DIN 1160A

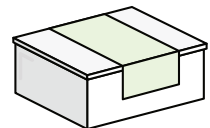

d [mm]	l [mm]	Art. ref.	EAN code			Price code	Packaging
2,7	30	GZOSNB027030	5410439600651	270 g	3	GH1	Box 2A
3	25	GZOSNB030025	5410439600644	270 g	3	GH1	Box 2A

GZOSNE



Schalienagel met extra brede kop DIN 1160B
 Pointe d'ardoise à tête extra large DIN 1160B
 Roofing nail with extra large head DIN 1160B
 Schieferstifte DIN 1160B

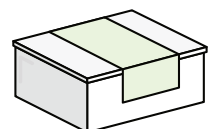

d [mm]	l [mm]	Art. ref.	EAN code			Price code	Packaging
3	20	GZOSNE030020	5410439600750	270 g	3	GH1	Box 2A
3	25	GZOSNE030025	5410439600767	270 g	3	GH1	Box 2A
3	40	GZOSNE030040	5410439600774	270 g	3	GH1	Box 2A



GZ5SNB



Schalienagel met extra brede kop DIN 1160B
 Pointe d'ardoise à tête extra large DIN 1160B
 Roofing nail with extra large head DIN 1160B
 Schieferstifte DIN 1160B

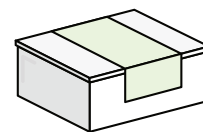

d [mm]	l [mm]	Art. ref.	EAN code			Price code	Packaging
2,7	30	GZ5SNB027030	5410439600675	1000 g	1	GL1	Box 5A





GZ5SNE

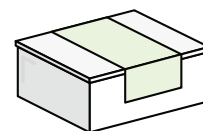

Schalienagel met extra brede kop DIN 1160B
 Pointe d'ardoise à tête extra large DIN 1160B
 Roofing nail with extra large head DIN 1160B
 Schieferstifte DIN 1160B



d [mm]	l [mm]	Art. ref.	EAN code			Price code	Packaging
3	15	GZ5SNE030015	5410439358293	1000 g	1	GL1	Box 4A
3	20	GZ5SNE030020	5410439600903	1000 g	1	GL1	Box 4A
3	25	GZ5SNE030025	5410439600910	1000 g	1	GL1	Box 5A
3	40	GZ5SNE030040	5410439600927	1000 g	1	GL1	Box 5A





GM1SNE



Schalienagel met extra brede kop DIN 1160B
 Pointe d'ardoise à tête extra large DIN 1160B
 Roofing nail with extra large head DIN 1160B
 Schieferstifte DIN 1160B



d [mm]	l [mm]	Art. ref.	EAN code			Price code	Packaging
2,5	27	GM1SNE025027	5410439297530	100 g	6	GH1	Blister B
2,5	30	GM1SNE025030	5410439297547	100 g	6	GH1	Blister B
2,8	40	GM1SNE028040	5410439297554	100 g	6	GH1	Blister B





GM0SNE

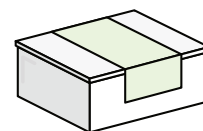

Schalienagel
 Pointe d'ardoise
 Roofing nail
 Schieferstifte



d [mm]	l [mm]	Art. ref.	EAN code			Price code	Packaging
2,5	30	GM0SNE025030	5410439401906	100	3	GM1	Box 1A
2,8	40	GM0SNE028040	5410439401913	100	3	GQ1	Box 2A
3	50	GM0SNE030050	5410439401920	100	3	GS1	Box 2A





GM5SNE

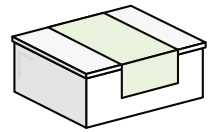

Schalienagel
Pointe d'ardoise
Roofing nail
Schieferstifte



d [mm]	l [mm]	Art. ref.	EAN code			Price code	Packaging
2,5	27	GM5SNE025027	5410439401937	500 g	1	GZ1	Box 4A
2,5	30	GM5SNE025030	5410439401944	500 g	1	GZ1	Box 4A
2,8	40	GM5SNE028040	5410439401951	500 g	1	GZ1	Box 4A



GMOSKR



Stormkram
Crampon tempête
Disc rivet
Sturmklammer

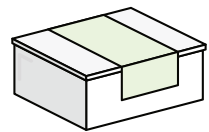

d [mm]	l [mm]	Art. ref.	EAN code			Price code	Packaging
2	20	GMOSKR020020	5410439401968	100	3	GQ1	Box 2A





GZ10KR

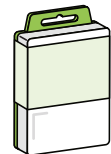

Kram Type U
Crampon type U
Cramp type U
Kram Typ U



d [mm]	l [mm]	Art. ref.	EAN code			Price code	Packaging
1,8	15	GZ10KR018015	5410439450409	40 g	12	GB1	Blister A
2	20	GZ10KR020020	5410439450805	50 g	12	GB1	Blister A
2,7	25	GZ10KR027025	5410439450812	60 g	12	GB1	Blister A
3	30	GZ10KR030030	5410439450829	60 g	12	GB1	Blister A
3,5	35	GZ10KR035035	5410439450836	60 g	12	GB1	Blister A



GZ00KR



Kram Type U
Crampon type U
Cramp type U
Kram Typ U

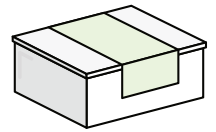

d [mm]	l [mm]	Art. ref.	EAN code			Price code	Packaging
1,8	15	GZ00KR018015	5410439401302	200 g	3	GH3	Box 1A
2	20	GZ00KR020020	5410439401319	260 g	3	GH1	Box 2A
2,7	25	GZ00KR027025	5410439401326	325 g	3	GH1	Box 2A
3	30	GZ00KR030030	5410439401333	350 g	3	GH1	Box 2A
3,5	35	GZ00KR035035	5410439401340	350 g	3	GH3	Box 2A



GZ50KR



Kram Type U
Crampon type U
Cramp type U
Kram Typ U

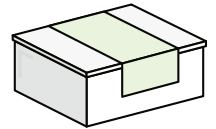

d [mm]	l [mm]	Art. ref.	EAN code			Price code	Packaging
1,8	15	GZ50KR018015	5410439401357	1000 g	1	GS1	Box 4A
2	20	GZ50KR020020	5410439401364	1000 g	1	GR1	Box 4A
2,7	25	GZ50KR027025	5410439401371	1000 g	1	GP1	Box 4A
3	30	GZ50KR030030	5410439401388	1000 g	1	GO1	Box 4A
3,5	35	GZ50KR035035	5410439401395	1000 g	1	GO1	Box 4A
4	40	GZ50KR040040	5410439145510	1000 g	1	GO1	Box 5A
4,5	45	GZ50KR045045	5410439145527	1000 g	1	GO1	Box 5A



GZ1GYN



Gipsplaatnagel
Pointe panneaux de plâtre
Plasterboard nail
Gipsplattennägel

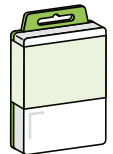

d [mm]	l [mm]	Art. ref.	EAN code			Price code	Packaging
2,2	32	GZ1GYN022032	5410439650106	100 g	6	GB1	Blister B
2,2	40	GZ1GYN022040	5410439650113	100 g	6	GB1	Blister B
2,2	50	GZ1GYN022050	5410439650120	100 g	6	GB1	Blister B
2,2	60	GZ1GYN022060	5410439650137	100 g	6	GB1	Blister B



GZ0GYN



Gipsplaatnagel
Pointe panneaux de plâtre
Plasterboard nail
Gipsplattennägel

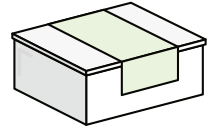

d [mm]	l [mm]	Art. ref.	EAN code			Price code	Packaging
2,2	32	GZ0GYN022032	5410439600453	300 g	3	GH1	Box 2A
2,2	40	GZ0GYN022040	5410439600460	300 g	3	GH1	Box 2A
2,2	50	GZ0GYN022050	5410439600477	300 g	3	GH1	Box 2A
2,2	60	GZ0GYN022060	5410439600484	300 g	3	GH1	Box 2A



GZ5GYN



Gipsplaatnagel
Pointe panneaux de plâtre
Plasterboard nail
Gipsplattennägel

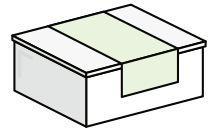

d [mm]	l [mm]	Art. ref.	EAN code			Price code	Packaging
2,2	32	GZ5GYN022032	5410439600507	1000 g	1	GL1	Box 5A
2,2	40	GZ5GYN022040	5410439600514	1000 g	1	GL1	Box 5A
2,2	50	GZ5GYN022050	5410439600521	900 g	1	GL1	Box 5A
2,2	60	GZ5GYN022060	5410439600538	800 g	1	GL1	Box 5A



GZ10PN



Plafonneernagel
Pointe plafonneur
Ceiling nail
Deckennägel

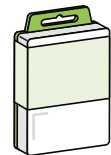

d [mm]	l [mm]	Art. ref.	EAN code			Price code	Packaging
2	25	GZ10PN020025	5410439650403	100 g	6	GB1	Blister B





GS10BN



Bloknagel
Semences hors tête
Tack
Blocknägel



d [mm]	l [mm]	Art. ref.	EAN code			Price code	Packaging
8	10	GS10BN080010	5410439450607	30 g	12	GA1	Blister A
12	12	GS10BN120012	5410439450614	30 g	12	GA1	Blister A
14	14	GS10BN140014	5410439450621	30 g	12	GA1	Blister A





GS00BN

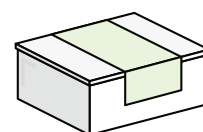

Bloknagel
Semence hors tête
Tacks
Deckennägel



d [mm]	l [mm]	Art. ref.	EAN code			Price code	Packaging
8	10	GS00BN080010	5410439401555	150 g	3	GH1	Box 1A
12	12	GS00BN120012	5410439401562	160 g	3	GH1	Box 1A
14	14	GS00BN140014	5410439401579	160 g	3	GH1	Box 1A





GZ1SNP



Schroefnagel
Pointe torsadées
Screw nail
Schraubenägel



d [mm]	l [mm]	Art. ref.	EAN code			Price code	Packaging
3,8	32	GZ1SNP038032	5410439450508	20	12	GB1	Blister A
3,8	40	GZ1SNP038040	5410439450515	15	12	GB1	Blister A
3,8	50	GZ1SNP038050	5410439127851	11	12	GB1	Blister A
3,8	60	GZ1SNP038060	5410439450539	10	12	GB1	Blister A



GZ0SNP



Schroefnagel
Pointe torsadées
Screw nail
Schraubenägel

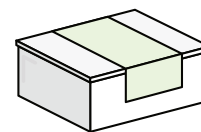

d [mm]	l [mm]	Art. ref.	EAN code			Price code	Packaging
3,8	32	GZ0SNP038032	5410439401401	85	3	GH1	Box 1A
3,8	40	GZ0SNP038040	5410439401418	60	3	GH1	Box 1A
3,8	50	GZ0SNP038050	5410439401425	50	3	GH1	Box 1A
3,8	60	GZ0SNP038060	5410439401432	40	3	GH1	Box 1A

GZ0ORN



Ribnagel met cilindrische kop
Pointe nervuré à tête cylindrique
Masonry nail ribbed Countersunk
Geriffelte Senkkopfstifte

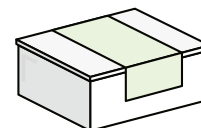

d [mm]	l [mm]	Art. ref.	EAN code			Price code	Packaging
3,5	35	GZ0ORN035035	5410439217002	250	1	GZ1	Box 3A
3,5	45	GZ0ORN035045	5410439216975	250	1	GZ1	Box 4A
3,5	55	GZ0ORN035055	5410439216982	250	1	GZ1	Box 4A
3,5	65	GZ0ORN035065	5410439216999	250	1	GZ1	Box 5A
4,5	80	GZ0ORN045080	5410439217033	200	1	GZ1	Box 5A

GZ10PD



Puntduim
Gond à pointe
Square hook pin
Stifthaken



d [mm]	l [mm]	Art. ref.	EAN code			Price code	Packaging
2,4	20	GZ10PD025020	5410439124768	18	12	GB1	Blister A
2,4	25	GZ10PD025025	5410439554817	16	12	GD1	Blister A
3,2	30	GZ10PD030030	5410439554824	13	12	GD1	Blister A
3,2	40	GZ10PD040040	5410439554831	8	12	GB1	Blister A
4	50	GZ10PD040050	5410439554848	8	12	GB1	Blister A
4	60	GZ10PD040060	5410439554855	5	12	GC1	Blister A
5	80	GZ10PD050080	5410439554862	4	12	GB1	Blister A



GZ00PD



Puntduim
Gond à pointe
Square hook pin
Stifthaken

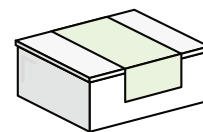

d [mm]	l [mm]	Art. ref.	EAN code			Price code	Packaging
2,25	20	GZ00PD022520	5410439554404	80	3	GH3	Box 1A
2,5	25	GZ00PD025025	5410439554411	70	3	GG1	Box 1A
3	30	GZ00PD030030	5410439554428	50	3	GH1	Box 1A
3	40	GZ00PD030040	5410439554435	27	3	GG1	Box 1A
3,5	50	GZ00PD035050	5410439554442	21	3	GG1	Box 1A
4	60	GZ00PD040060	5410439554459	14	3	GG1	Box 1A
5	70	GZ00PD050070	5410439554466	13	3	GG1	Box 1A
5	80	GZ00PD050080	5410439554473	11	3	GG1	Box 1A

GZ10BH



Balkhaak
Crampon solin
Square crooked nail
Viereckige Hakenstifte



d [mm]	l [mm]	Art. ref.	EAN code			Price code	Packaging
5	40	GZ10BH000040	5410439386913	4	12	GB1	Blister A
5	50	GZ10BH000050	5410439386920	4	12	GB1	Blister A
5	60	GZ10BH000060	5410439386937	4	12	GB1	Blister A

GZ00BH



Balkhaak
Crampon solin
Square crooked nail
Viereckige Hakenstifte

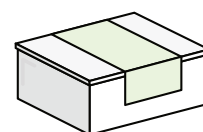

d [mm]	l [mm]	Art. ref.	EAN code			Price code	Packaging
5	40	GZ00BH000040	5410439386876	250 g	3	GH3	Box 2A
5	50	GZ00BH000050	5410439386883	250 g	3	GH3	Box 2A
5	60	GZ00BH000060	5410439386890	250 g	3	GH3	Box 2A



GZ50BH



Balkhaak
Crampon solin
Square crooked nail
Viereckige Hakenstifte

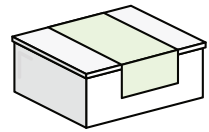

d [mm]	l [mm]	Art. ref.	EAN code			Price code	Packaging
5	40	GZ50BH000040	5410439390101	1000 g	1	GS1	Box 4A
5	50	GZ50BH000050	5410439386951	1000 g	1	GS1	Box 4A
5	60	GZ50BH000060	5410439386968	1000 g	1	GS1	Box 4A



GT1VKH



Vierkante konsoolhaak
Crochet carré
Steel hook
Konsolhaken

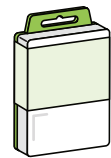

l [mm]	Art. ref.	EAN code			Price code	Packaging
40	GT1VKH000040	5410439387064	22	12	GE1	Blister A
50	GT1VKH000050	5410439387101	14	12	GE1	Blister A
60	GT1VKH000060	5410439387118	10	12	GE1	Blister A
70	GT1VKH000070	5410439387125	8	12	GE1	Blister A



GT0VKH



Vierkante konsoolhaak
Crochet carré
Steel hook
Konsolhaken

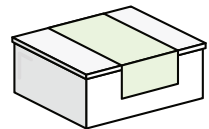

l [mm]	Art. ref.	EAN code			Price code	Packaging
40	GT0VKH000040	5410439387071	70	3	GJ1	Box 1A
50	GT0VKH000050	5410439387248	40	3	GJ1	Box 1A
60	GT0VKH000060	5410439387088	30	3	GJ1	Box 1A
70	GT0VKH000070	5410439387095	20	3	GJ1	Box 1A



GT1SHV



Haak V-vorm
Crochet forme-V
Wall hook
Stahlwandhaken



l [mm]	Art. ref.	EAN code			Price code	Packaging
40	GT1SHV000040	5410439387026	9	12	GE1	Blister A
50	GT1SHV000050	5410439387033	7	12	GE1	Blister A
60	GT1SHV000060	5410439387040	6	12	GE1	Blister A
70	GT1SHV000070	5410439387057	5	12	GE1	Blister A



GT0SHV



Haak V-vorm
Crochet forme-V
Wall hook
Stahlwandhaken

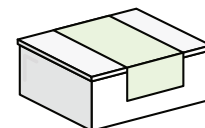

l [mm]	Art. ref.	EAN code			Price code	Packaging
40	GT0SHV000040	5410439386982	20	3	GI1	Box 1A
50	GT0SHV000050	5410439386999	16	3	GI1	Box 1A
60	GT0SHV000060	5410439387002	14	3	GI1	Box 1A
70	GT0SHV000070	5410439387019	10	3	GI1	Box 1A



GS1SZK



Stift zonder kop
Pointe sans tete
Nail without head
Goldleistenstifte



l [mm]	Art. ref.	EAN code			Price code	Packaging
9	GS1SZK009032	5410439450751	100	12	GH1	Blister A



GZOKLE



Klem met nagel
Clip pour landris avec pointe
Join claw & nail
Profilbrettkralle & Stifte

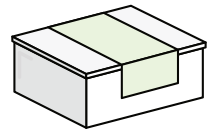

d [mm]	Art. ref.	EAN code			Price code	Packaging
1 mm	GZOKLE010000	5410439508001	200	1	GM1	Box 4A
2 mm	GZOKLE020000	5410439508100	200	1	GL1	Box 5A
3 mm	GZOKLE030000	5410439508117	200	1	GL1	Box 5A
4 mm	GZOKLE040000	5410439508124	200	1	GL1	Box 5A
5 mm	GZOKLE050000	5410439508131	100	1	GL1	Box 5A



GZ0NPK



Nagel voor klemmen
Pointe pour chrochets
Nails
Drahtstifte rund Senkkopf

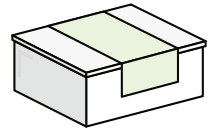

d [mm]	l [mm]	Art. ref.	EAN code			Price code	Packaging
1,8	20	GZ0NPK018020	5410439508155	200 g	3	GA1	Box 1A

GK10PP



Prikpin
Punaise
Push pin
Pinwandstifte

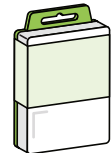

d [mm]	Art. ref.	EAN code	Colour			Price code	Packaging
1	GK10PP000000	5410439127042		24	12	GB1	Blister A
1	GK10PP010000	5410439127059		24	12	GB1	Blister A
1	GK10PP020000	5410439127066		24	12	GB1	Blister A
1	GK10PP040000	5410439127073		24	12	GB1	Blister A
1	GK10PP050000	5410439127103		24	12	GB1	Blister A
1	GK10PP060000	5410439127080		24	12	GB1	Blister A
1	GK10PP090000	5410439127097		24	12	GB1	Blister A



GM1DSP



Duimspijker
Punaise
Drawing pin
Reißzwecke



d [mm]	Art. ref.	EAN code	Colour			Price code	Packaging
1	GM1DSP010000	5410439451000		80	12	GB1	Blister A
1	GM1DSP020000	5410439451017		40	12	GB1	Blister A
1	GM1DSP030000	5410439451024		40	12	GB1	Blister A



GM1SIN



Siernagel
Pointe de garnissage
Decoration nail
PolSternägel



d [mm]	Art. ref.	EAN code			Price code	Packaging
1	GM1SIN010000	5410439451208	24	12	GB1	Blister A
2	GM1SIN020000	5410439451215	24	12	GB1	Blister A
3	GM1SIN030000	5410439451222	16	12	GB1	Blister A



GM10KH



Kaderhechting
Attache cadre
Wall hook
Bilderklappösen



d [mm]	Art. ref.	EAN code			Price code	Packaging
11	GM10KH110000	5410439451307	10	12	GB1	Blister A
13	GM10KH130000	5410439451314	9	12	GB1	Blister A
16	GM10KH160000	5410439451321	7	12	GB1	Blister A



GM1XWH



X-Wandhaak voor kader
Crochet x pour cadre
Wall hook & pin
Bilderhaken

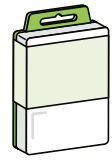

l [mm]	Art. ref.	EAN code			Price code	Packaging
21	GM1XWH010000	5410439451406	14	12	GB1	Blister A
29	GM1XWH020000	5410439451413	12	12	GB1	Blister A
30	GM1XWH030000	5410439451420	6	12	GB1	Blister A
33	GM1XWH040000	5410439451437	4	6	GB1	Blister B



GM1XWH NAILS



Nagel voor x-Wandhaak voor kaders
Pointe pour Crochet x pour cadre
Nail for wall hook
Drahtstifte für Bilderhaken

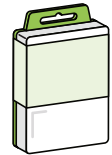

d [mm]	l [mm]	Art. ref.	EAN code			Price code	Packaging
1,4	26	GM1XWH014026	5410439451468	40	12	GB1	Blister A



GM1ZKH



Zelfklevende kaderhaakjes rond
Attaches cadres autocollant
Self-adhesive wall hook
Selbstklebende Bilderklappöse

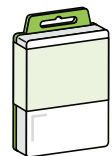

d [mm]	Art. ref.	EAN code			Price code	Packaging
30	GM1ZKH000030	5410439388450	10	12	GE1	Blister A

MEUBELVERBINDERS
CONNECTEURS POUR MEUBLES
FURNITURE FIXINGS
MÖBELBEFESTIGUNGEN



GK1OPH



Ophanghaakje
 Crochet
 Picture hook
 Betonhaken



d [mm]	Art. ref.	EAN code			Price code	Packaging
1	GK1OPH010000	5410439451246	8	12	GE1	Blister A
2	GK1OPH020000	5410439451239	6	12	GE1	Blister A
3	GK1OPH030000	5410439451253	4	6	GE1	Blister B



GK1VSB



Verbindingsschroef met kapje
 Vis de connection avec capuchon
 Connecting screw bolt with cap
 Verbundschraube mit Kappe



d [mm]	l [mm]	Art. ref.	EAN code			Price code	Packaging
6	29	GK1VSB029036	5410439124751	6	6	GG1	Blister B
6	34	GK1VSB034041	5410439124744	6	6	GG1	Blister B



GK1VSW



Verbindingsschroef met kapje
 Vis de connection avec capuchon
 Connecting screw bolt with cap
 Verbundschraube mit Kappe



d [mm]	l [mm]	Art. ref.	EAN code			Price code	Packaging
6	29	GK1VSW029036	5410439555401	6	6	GG1	Blister B
6	34	GK1VSW034041	5410439555425	6	6	GG1	Blister B

GK1WPL



Waterpaslatje
Baguette de nivelation
Furniture wedge
Möbelkeile

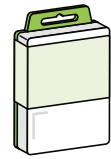

d [mm]	Art. ref.	EAN code			Price code	Packaging
1	GK1WPL010000	5410439555494	3	3	GC1	Blister E

GZ1ME3



Bodendrager
Support tablettes
Shelf supports duplo
Bodenträger

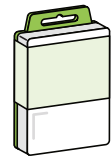

d [mm]	Art. ref.	EAN code			Price code	Packaging
3	GZ1ME3010000	5410439451659	20	12	GB1	Blister A

GK1ME1



Plastic schabdrager (rond) & nagel
Taquet rond en plast. & pointe
Plastic shelf support (round) & nail
Kunststoffbodenträger (rund) & Nägel

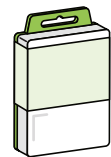

l [mm]	Art. ref.	EAN code	Colour			Price code	Packaging
1	GK1ME1010000	5410439451505	White	10	12	GC1	Blister A
1	GK1ME1020000	5410439451512	Brown	10	12	GC1	Blister A













BlackTop
coating





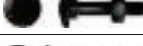

Quality by **pgb**

WOOD SCREWS

GB1571			83
GB0571			83
GB1603			84
GB0603			84
GB10WP			85





WOOD CONSTRUCTION SCREWS

GB0TTG			86
GB1TTG			86

HARDWOOD SCREWS

GB1HTG			87
--------	---	---	----

NUTS

GB1934			88
GB1587			88

WASHERS

GB1125			89
GB1021			89

HOUTSCHROEVEN
VIS À BOIS
WOOD SCREWS
HOLZSCHRAUBEN



GB1571

BLACK
TOP

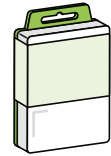

Houtdraadbout met zeskantkop DIN 571
 Tirefond tête hexagonal DIN 571
 Hexagon coach screw DIN 571
 Sechskant-Holzschraube DIN 571



d [mm]	l [mm]	Art. ref.	EAN code			Price code	Packaging
6	30	GB1571060030	5410439074445	12	6	GD1	Blister B
6	40	GB1571060040	5410439074469	12	6	GE1	Blister B
6	50	GB1571060050	5410439074483	12	6	GF1	Blister B
6	60	GB1571060060	5410439074506	8	6	GE1	Blister B
8	30	GB1571080030	5410439074520	6	6	GD1	Blister B
8	35	GB1571080035	5410439074551	6	6	GD1	Blister B
8	40	GB1571080040	5410439074575	6	6	GE1	Blister B
8	50	GB1571080050	5410439074605	6	6	GE1	Blister B
8	60	GB1571080060	5410439074643	6	6	GF1	Blister B
8	70	GB1571080070	5410439074650	6	6	GG1	Blister B



GB0571

BLACK
TOP

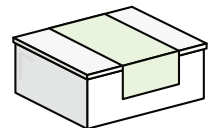

Houtdraadbout met zeskantkop DIN 571
 Tirefond tête hexagonal DIN 571
 Hexagon coach screw DIN 571
 Sechskant-Holzschraube DIN 571



d [mm]	l [mm]	Art. ref.	EAN code			Price code	Packaging
6	30	GB0571060030	5410439152655	20	3	GH3	Box 1A
6	40	GB0571060040	5410439152648	20	3	GJ1	Box 1A
6	50	GB0571060050	5410439152631	20	1	GK1	Box 1A
8	30	GB0571080030	5410439152624	20	1	GK1	Box 2A
8	40	GB0571080040	5410439152617	20	1	GL1	Box 2A
8	50	GB0571080050	5410439152600	20	1	GN1	Box 2A
8	60	GB0571080060	5410439152594	20	1	G01	Box 2A



GB1603

4.8

BLACK
TOP

Houtbout met moer DIN 603/555
 Boulon à bois avec écrou DIN 603/555
 Carriage bolt with nut DIN 603/555
 Flachrundschaube mit Mutter DIN 603/555





d [mm]	l [mm]	Art. ref.	EAN code			Price code	Packaging
M 6	30	GB1603060030	5410439074667	6	6	GE1	Blister B
M 6	40	GB1603060040	5410439074674	6	6	GE1	Blister B
M 6	50	GB1603060050	5410439074681	6	6	GF1	Blister B
M 6	60	GB1603060060	5410439074698	6	6	GG1	Blister B
M 6	70	GB1603060070	5410439074704	4	6	GF1	Blister B
M 8	30	GB1603080030	5410439074711	6	6	GG1	Blister B
M 8	40	GB1603080040	5410439074728	6	6	GG1	Blister B
M 8	45	GB1603080045	5410439074735	6	6	GH1	Blister B
M 8	50	GB1603080050	5410439074742	6	6	GH1	Blister B
M 8	55	GB1603080055	5410439074759	4	6	GG1	Blister B
M 8	60	GB1603080060	5410439074766	4	6	GH1	Blister B
M 8	70	GB1603080070	5410439074773	6	3	GH3	Blister E
M 8	80	GB1603080080	5410439075206	6	3	GH3	Blister E
M 8	90	GB1603080090	5410439074780	6	3	GI1	Blister E
M 8	100	GB1603080100	5410439075213	6	3	GI1	Blister E

GB0603

BLACK
TOP

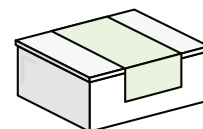
Houtbout met moer DIN 603/555
 Boulon à bois avec écrou DIN 603/555
 Carriage bolt with nut DIN 603/555
 Flachrundschaube mit Mutter DIN 603/555





d [mm]	l [mm]	Art. ref.	EAN code			Price code	Packaging
M 6	30	GB0603060030	5410439152587	20	1	GM1	Box 2A
M 6	40	GB0603060040	5410439152570	20	1	GM1	Box 2A
M 6	50	GB0603060050	5410439152563	20	1	GO1	Box 2A
M 8	30	GB0603080030	5410439152556	20	1	GP1	Box 2A
M 8	40	GB0603080040	5410439152549	20	1	GS1	Box 3A
M 8	50	GB0603080050	5410439152525	20	1	GT1	Box 3A
M 8	60	GB0603080060	5410439152518	20	1	GW1	Box 3A

GB10WP



Spaanderplaatschroef met verzonken kop
 Vis agglo à tête fraisée
 Chipboard screw with countersunk head
 Spanplattenschraube mit Senkkopf



d [mm]	l [mm]	Art. ref.	EAN code			Price code	Packaging
3	20	GB10WP030020	5410439075046	25	12	GA1	Blister A
3	25	GB10WP030025	5410439075053	25	12	GB1	Blister A
3	30	GB10WP030030	5410439075060	25	12	GB1	Blister A
3,5	16	GB10WP035016	5410439075077	25	12	GB1	Blister A
4	16	GB10WP040016	5410439075084	25	12	GB1	Blister A
4	20	GB10WP040020	5410439075091	25	12	GB1	Blister A
4	25	GB10WP040025	5410439075107	25	12	GC1	Blister A
4	30	GB10WP040030	5410439075114	25	12	GC1	Blister A
4	40	GB10WP040040	5410439075121	20	12	GB1	Blister A
4	50	GB10WP040050	5410439075138	20	12	GC1	Blister A
4,5	16	GB10WP045016	5410439075145	25	12	GB1	Blister A
4,5	20	GB10WP045020	5410439075152	25	12	GC1	Blister A
4,5	30	GB10WP045030	5410439075169	25	12	GA1	Blister A
5	40	GB10WP050040	5410439075176	10	12	GB1	Blister A
5	50	GB10WP050050	5410439075183	10	12	GB1	Blister A
6	50	GB10WP060050	5410439075190	10	12	GC1	Blister A

HOUTCONSTRUCTIESCHROEVEN
VIS POUR CONSTRUCTION À BOIS
WOOD CONSTRUCTION SCREWS
HOLZBAUSCHRAUBEN





GB1TTG



Houtconstructieschroef met flenskop PFS+
 Vis pour construction en bois tête disque PFS+
 Wood construction screw with flange head PFS+
 Holzbauschraube mit Tellerkopf PFS+



d [mm]	l [mm]	Art. ref.	EAN code			Price code	Packaging
6	30	GB1TTG060030	5410439074872	6	6	GD1	Blister B
6	40	GB1TTG060040	5410439074889	6	6	GE1	Blister B
6	50	GB1TTG060050	5410439074896	6	6	GF1	Blister B
8	40	GB1TTG080040	5410439074902	6	6	GG1	Blister B
8	50	GB1TTG080050	5410439074919	6	6	GH1	Blister B
8	60	GB1TTG080060	5410439074926	6	6	GH3	Blister B
8	80	GB1TTG080080	5410439075220	6	3	GI1	Blister E
8	100	GB1TTG080100	5410439075237	6	3	GJ1	Blister E





GB0TTG

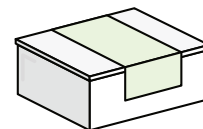

Houtconstructieschroef met flenskop PFS+
 Vis pour construction en bois tête disque PFS+
 Wood construction screw with flange head PFS+
 Holzbauschraube mit Tellerkopf PFS+



d [mm]	l [mm]	Art. ref.	EAN code			Price code	Packaging
6	30	GB0TTG060030	5410439152501	20	1	GH3	Box 1A
6	40	GB0TTG060040	5410439152495	20	1	GI1	Box 1A
6	50	GB0TTG060050	5410439152464	20	1	GK1	Box 1A
8	40	GB0TTG080040	5410439152457	20	1	GQ1	Box 2A
8	50	GB0TTG080050	5410439152440	20	1	GR1	Box 2A
8	60	GB0TTG080060	5410439152433	20	1	GU1	Box 2A



HARDHOUTSCHROEVEN
VIS À BOIS DUR
HARDWOOD SCREWS
HARTHOLZSCHRAUBEN

GB1HTG



Potdekselschroef PFS+ met zwart verzonken kop
 Vis pour bardage PFS+ tête noire
 Siding panel screw PFS+ black head
 Stulpschalungsschraube PFS+ Schwarz



d [mm]	l [mm]	Art. ref.	EAN code			Price code	Packaging
4	30	GB1HTG040030	5410439074933	50	6	GK1	Blister B
4	40	GB1HTG040040	5410439074940	50	6	GK1	Blister B
4	45	GB1HTG040045	5410439074957	40	6	GK1	Blister B
4	50	GB1HTG040050	5410439074964	40	6	GK1	Blister B
4	60	GB1HTG040060	5410439074971	25	6	GJ1	Blister B
4,5	50	GB1HTG045050	5410439074988	40	6	GL1	Blister B
5	40	GB1HTG050040	5410439074995	40	6	GL1	Blister B
5	50	GB1HTG050050	5410439075008	40	6	GM1	Blister B
5	60	GB1HTG050060	5410439075015	40	6	GO1	Blister B
5	70	GB1HTG050070	5410439075022	25	3	GM1	Blister E
5	80	GB1HTG050080	5410439075039	20	3	GL1	Blister E

MOEREN
ÉCROUS
NUTS
MUTTERN



GB1934

|8|

BLACK
TOP

Zeskantmoer DIN 934
Ecrou hexagonal DIN 934
Hexagon nut DIN 934
Sechskantmutter DIN 934





d [mm]	Art. ref.	EAN code			Price code	Packaging
M 6	GB1934060000	5410439074797	20	12	GC1	Blister A
M 8	GB1934080000	5410439074803	12	12	GC1	Blister A

GB1587

BLACK
TOP

Zeskant dopmoer DIN 1587
Ecrou borgne hexagonal DIN 1587
Hexagon domed cap nut DIN 1587
Sechskant-Hutmutter DIN 1587



d [mm]	Art. ref.	EAN code			Price code	Packaging
M 6	GB1587060000	5410439074810	12	12	GC1	Blister A
M 8	GB1587080000	5410439074827	6	12	GC1	Blister A

SLUITRINGEN
RONDELLES
WASHERS
SCHEIBEN

GB1125



140
HV

BLACK
TOP



Sluitring DIN 125A
 Rondelle DIN 125A
 Washer DIN 125A
 Scheibe DIN 125A



d [mm]	d _e [mm]	Art. ref.	EAN code			Price code	Packaging
M 6	12	GB1125060000	5410439074421	30	12	GC1	Blister A
M 8	16	GB1125080000	5410439074438	20	12	GC1	Blister A

GB1021



140
HV

BLACK
TOP

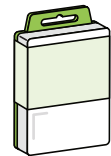

Sluitring DIN 9021
 Rondelle DIN 9021
 Washer DIN 9021
 Scheibe DIN 9021



d [mm]	d _e [mm]	Art. ref.	EAN code			Price code	Packaging
M 6	18	GB1021060000	5410439074834	20	12	GC1	Blister A
M 8	24	GB1021080000	5410439074841	12	12	GC1	Blister A





**METAALBEVESTIGINGEN
FIXATIONS POUR MÉTAL
METAL FASTENERS
BEFESTIGUNGEN FÜR METALL**

HEXAGON HEAD SCREWS

BZ1601		94
BZ0601		95
BZ1601		94
BZ1933		96
BZ0933		97
BV1048		99

MACHINE SCREWS

BZ1084		101
BZ0084		101
BZ1963		102
BZ0963		103
BZ10VP		103
BZ00VP		104

SOCKET SCREWS

BZ1912		106
BZ1916		107
BZ1991		108

VARIOUS HEAD FORMS

BZ1316		110
BZ1MSH		110
BZ1MSO		110

SCREWS WITHOUT HEAD

BZ1976		111
BZ10SE		111
BZ1SEB		112

NUTS

BZ1439		113
BZ1934		113
BZ0934		114
BM1934		114
BZ1334		114
BZ1985		115
BZ0985		115
BZ10IM		116

















BZ00IM		116
BZ1315		116
BZ1587		117
BZ1796		117
BZ0796		117
BK0AFD		118
BV1032		118

WASHERS

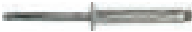
BZ1125		119
BZ0125		119
BM1125		120
BZ1021		120
BZ0021		121
BV1089		121
BZ1798		122
BZ0798		122
BZ1127		122
BZ0127		123
BZ10NR		123
BM1CUV		124
BN1CUV		124
BN10SR		124
BM10DK		124
BM10ZR		125

SELFDRILLING/TAPPING SCREWS

BZ1981		126
BZ0981		127
BZ1983		127
BZ0983		128
BZ104K		128
BZ004K		129
BZ104N		130
BZ004N		130
BZ104P		131
BZ004P		131

BZ0G16			132
PINS AND RIVETS			
BZ1094			133
BZ0094			133
BZ1024			133
BM10BR			134
BZ137A			134
BZ037A			135
BZ137C			137
BZ037C			137



ZESKANTSBOUTEN
BOULONS HEXAGONALES
HEXAGON HEAD SCREWS
SECHSKANTSCHRAUBEN

BZ1601



Zeskantbout met moer DIN 931/934
Boulon hexagonale avec écrou DIN 931/934
Hexagonal bolt and nut DIN 931/934
Sechskantschraube mit Mutter DIN 931/934



d [mm]	l [mm]	Art. ref.	EAN code			Price code	Packaging
M 6	25	BZ1601060025	5410439384025	13	12	BC1	Blister A
M 6	30	BZ1601060030	5410439384032	12	12	BC1	Blister A
M 6	40	BZ1601060040	5410439384049	10	12	BC1	Blister A
M 6	50	BZ1601060050	5410439384056	8	12	BC1	Blister A
M 6	60	BZ1601060060	5410439384063	7	6	BC1	Blister B
M 6	80	BZ1601060080	5410439120562	6	3	BC1	Blister E
M 6	100	BZ1601060100	5410439120579	8	3	BE1	Blister E
M 6	120	BZ1601060120	5410439120586	4	3	BH1	Blister E
M 8	30	BZ1601080030	5410439384131	7	6	BC1	Blister B
M 8	35	BZ1601080035	5410439384148	6	6	BC1	Blister B
M 8	40	BZ1601080040	5410439384155	6	6	BC1	Blister B
M 8	50	BZ1601080050	5410439384162	5	6	BC1	Blister B
M 8	60	BZ1601080060	5410439384179	4	6	BC1	Blister B
M 8	70	BZ1601080070	5410439120593	8	3	BF1	Blister E
M 8	80	BZ1601080080	5410439120609	8	3	BF1	Blister E
M 8	100	BZ1601080100	5410439120616	6	3	BF1	Blister E
M 10	40	BZ1601100040	5410439120630	10	3	BH3	Blister E
M 10	50	BZ1601100050	5410439120647	8	3	BH1	Blister E
M 10	60	BZ1601100060	5410439384247	8	3	BH3	Blister E
M 10	70	BZ1601100070	5410439120654	8	3	BH3	Blister E
M 10	80	BZ1601100080	5410439120661	6	3	BH1	Blister E
M 10	100	BZ1601100100	5410439120678	6	3	BH3	Blister E
M 12	40	BZ1601120040	5410439384285	4	6	BE1	Blister B
M 12	50	BZ1601120050	5410439384292	4	3	BE1	Blister E
M 12	60	BZ1601120060	5410439120685	6	3	BH3	Blister E
M 12	70	BZ1601120070	5410439120692	6	3	BH3	Blister E
M 12	80	BZ1601120080	5410439120708	6	3	BH3	Blister E
M 12	100	BZ1601120100	5410439120715	4	3	BH1	Blister E
M 12	120	BZ1601120120	5410439124713	4	3	BI1	Blister E
M 12	140	BZ1601120140	5410439124720	4	1	BK1	Blister H

BZ1601

8.8



Zeskantbout met moer DIN 931/934
 Boulon hexagonale avec écrou DIN 931/934
 Hexagonal bolt and nut DIN 931/934
 Sechskantschraube mit Mutter DIN 931/934

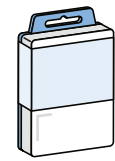

d [mm]	l [mm]	Art. ref.	EAN code			Price code	Packaging
M 14	70	BZ1931140070	5410439124591	6	1	BM1	Blister H
M 14	80	BZ1931140080	5410439111072	6	1	BJ1	Blister H
M 14	90	BZ1931140090	5410439111089	6	1	BK1	Blister H
M 14	100	BZ1931140100	5410439111096	6	1	BK1	Blister H
M 14	120	BZ1931140120	5410439111102	6	1	BL1	Blister H
M 16	100	BZ1931160100	5410439110334	3	1	BJ1	Blister H
M 16	120	BZ1931160120	5410439110341	3	1	BJ1	Blister H
M 20	100	BZ1931200100	5410439110358	3	1	BM1	Blister H
M 20	120	BZ1931200120	5410439110365	3	1	BN1	Blister H

BZ0601

8.8



Zeskantbout met moer DIN 931/934
 Boulon hexagonale avec écrou DIN 931/934
 Hexagonal bolt and nut DIN 931/934
 Sechskantschraube mit Mutter DIN 931/934

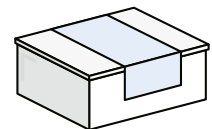

d [mm]	l [mm]	Art. ref.	EAN code			Price code	Packaging
M 6	25	BZ0601060025	5410439304023	50	1	BH3	Box 3A
M 6	30	BZ0601060030	5410439304030	50	3	BI1	Box 2A
M 6	40	BZ0601060040	5410439304047	50	1	BJ1	Box 4A
M 6	50	BZ0601060050	5410439304054	50	1	BK1	Box 4A
M 6	60	BZ0601060060	5410439304061	50	1	BL1	Box 4A
M 6	80	BZ0601060080	5410439304078	50	1	BM1	Box 4A
M 6	100	BZ0601060100	5410439304085	25	1	BJ1	Box 4A
M 8	30	BZ0601080030	5410439304146	50	1	BL1	Box 4A
M 8	35	BZ0601080035	5410439304153	50	1	BM1	Box 4A
M 8	40	BZ0601080040	5410439304160	50	1	BN1	Box 4A
M 8	50	BZ0601080050	5410439304177	50	1	BO1	Box 4A
M 8	60	BZ0601080060	5410439304184	50	1	BP1	Box 4A
M 8	70	BZ0601080070	5410439304191	50	1	BQ1	Box 5A
M 8	80	BZ0601080080	5410439304207	50	1	BS1	Box 5A
M 8	100	BZ0601080100	5410439304214	25	1	BM1	Box 4A
M 10	40	BZ0601100040	5410439304245	25	1	BM1	Box 4A
M 10	50	BZ0601100050	5410439304252	25	1	BN1	Box 4A
M 10	60	BZ0601100060	5410439304269	25	1	BO1	Box 4A
M 10	70	BZ0601100070	5410439304276	25	1	BP1	Box 4A
M 10	80	BZ0601100080	5410439304283	25	1	BP1	Box 5A
M 10	100	BZ0601100100	5410439304290	20	1	BQ1	Box 4A

BZ1601

8.8



Zeskantbout met moer DIN 931/934
 Boulon hexagonale avec écrou DIN 931/934
 Hexagonal bolt and nut DIN 931/934
 Sechskantschraube mit Mutter DIN 931/934



d [mm]	l [mm]	Art. ref.	EAN code			Price code	Packaging
M 10	120	BZ0601100120	5410439304306	15	1	BO1	Box 5A
M 12	40	BZ0601120040	5410439304368	25	1	BP1	Box 4A
M 12	50	BZ0601120050	5410439304313	20	1	BO1	Box 4A
M 12	60	BZ0601120060	5410439304320	20	1	BP1	Box 4A
M 12	70	BZ0601120070	5410439304337	15	1	BN1	Box 4A
M 12	80	BZ0601120080	5410439304344	15	1	BO1	Box 4A
M 12	100	BZ0601120100	5410439304351	15	1	BQ1	Box 5A

BZ1933

8.8



Zeskantbout met moer DIN 933/934
 Vis à tête hexagonal avec écrou DIN 933/934
 Hexagonal screw with nut DIN 933/934
 Sechskantschraube mit Mutter DIN 933/934



d [mm]	l [mm]	Art. ref.	EAN code			Price code	Packaging
M 6	16	BZ1601060016	5410439384001	15	12	BC1	B blister A
M 6	20	BZ1601060020	5410439384018	14	12	BC1	B blister A
M 8	16	BZ1601080016	5410439384100	8	6	BC1	B blister B
M 8	20	BZ1601080020	5410439384117	8	6	BC1	B blister B
M 8	25	BZ1601080025	5410439384124	7	6	BC1	B blister B
M 10	30	BZ1601100030	5410439120623	12	3	BH3	B blister E
M 3	16	BZ1933030016	5410439353304	15	12	BB1	B blister A
M 3	20	BZ1933030020	5410439353311	14	12	BB1	B blister A
M 4	16	BZ1933040016	5410439353403	12	12	BB1	B blister A
M 4	20	BZ1933040020	5410439353410	11	12	BB1	B blister A
M 4	30	BZ1933040030	5410439353427	10	12	BB1	B blister A
M 5	16	BZ1933050016	5410439353502	17	12	BC1	B blister A
M 5	20	BZ1933050020	5410439353519	16	12	BC1	B blister A
M 5	25	BZ1933050025	5410439353526	15	12	BC1	B blister A
M 5	30	BZ1933050030	5410439353533	14	12	BC1	B blister A
M 6	16	BZ1933060016	5410439353595	15	6	BC1	B blister A
M 6	20	BZ1933060020	5410439353601	14	6	BC1	B blister A
M 6	25	BZ1933060025	5410439124911	13	6	BC1	B blister A
M 6	30	BZ1933060030	5410439353618	12	6	BC1	B blister A
M 6	40	BZ1933060040	5410439353625	10	6	BC1	B blister A
M 6	50	BZ1933060050	5410439353632	8	12	BC1	B blister A
M 6	80	BZ1933060080	5410439120722	8	3	BD1	B blister E
M 8	16	BZ1933080016	5410439124928	8	6	BC1	B blister B

BZ1933

8.8



Zeskantbout met moer DIN 933/934

Vis à tête hexagonal avec écrou DIN 933/934

Hexagonal screw with nut DIN 933/934

Sechskantschraube mit Mutter DIN 933/934

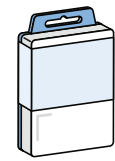

d [mm]	l [mm]	Art. ref.	EAN code			Price code	Packaging
M 8	20	BZ1933080020	5410439353700	8	6	BC1	Blister B
M 8	25	BZ1933080025	5410439124935	7	6	BC1	Blister B
M 8	30	BZ1933080030	5410439353717	7	6	BC1	Blister B
M 8	35	BZ1933080035	5410439124942	6	6	BC1	Blister B
M 8	40	BZ1933080040	5410439353724	6	6	BC1	Blister B
M 8	50	BZ1933080050	5410439353731	5	6	BC1	Blister B
M 8	60	BZ1933080060	5410439353748	4	6	BC1	Blister B
M 10	30	BZ1933100030	5410439120739	11	3	BH3	Blister E
M 10	40	BZ1933100040	5410439120746	9	3	BH3	Blister E
M 10	50	BZ1933100050	5410439120753	8	3	BH3	Blister E
M 10	60	BZ1933100060	5410439120760	7	3	BH3	Blister E
M 10	70	BZ1933100070	5410439120777	6	3	BH3	Blister E
M 10	80	BZ1933100080	5410439120784	5	3	BH3	Blister E
M 10	100	BZ1933100100	5410439120791	4	3	BH3	Blister E
M 12	30	BZ1933120030	5410439122122	6	3	BH3	Blister E
M 12	40	BZ1933120040	5410439110990	6	3	BH1	Blister E
M 12	50	BZ1933120050	5410439111003	6	3	BH1	Blister E
M 12	60	BZ1933120060	5410439111010	6	3	BH3	Blister E
M 14	30	BZ1933140030	5410439111027	6	1	BJ1	Blister H
M 14	40	BZ1933140040	5410439111034	6	1	BJ1	Blister H
M 14	50	BZ1933140050	5410439122184	6	1	BK1	Blister H
M 14	60	BZ1933140060	5410439111058	6	1	BL1	Blister H
M 16	40	BZ1933160040	5410439108997	5	1	BI1	Blister H
M 16	50	BZ1933160050	5410439109536	5	1	BJ1	Blister H
M 16	60	BZ1933160060	5410439110280	5	1	BK1	Blister H
M 16	80	BZ1933160080	5410439124737	5	1	BK1	Blister H
M 20	50	BZ1933200050	5410439110303	5	1	BN1	Blister H
M 20	60	BZ1933200060	5410439110310	5	1	BN1	Blister H
M 20	80	BZ1933200080	5410439110327	5	1	BO1	Blister H

BZ0933

8.8



Zeskantbout met moer DIN 933/934

Vis à tête hexagonal avec écrou DIN 933/934

Hexagonal screw with nut DIN 933/934

Sechskantschraube mit Mutter DIN 933/934

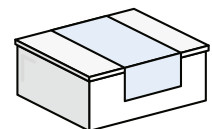

d [mm]	l [mm]	Art. ref.	EAN code			Price code	Packaging
M 6	16	BZ0601060016	5410439304009	50	3	BH3	Box 2A

BZ0933

8.8



Zeskantbout met moer DIN 933/934
 Vis à tête hexagonal avec écrou DIN 933/934
 Hexagonal screw with nut DIN 933/934
 Sechskantschraube mit Mutter DIN 933/934

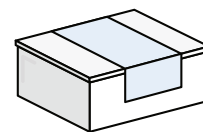

d [mm]	l [mm]	Art. ref.	EAN code			Price code	Packaging
M 6	20	BZ0601060020	5410439304016	50	3	BH3	Box 2A
M 8	16	BZ0601080016	5410439304115	50	1	BK1	Box 4A
M 8	20	BZ0601080020	5410439304122	50	1	BK1	Box 4A
M 8	25	BZ0601080025	5410439304139	50	1	BL1	Box 4A
M 10	30	BZ0601100030	5410439304238	25	1	BL1	Box 4A
M 3	10	BZ0933030010	5410439274623	40	3	BH1	Box 1A
M 3	16	BZ0933030016	5410439404006	40	3	BH1	Box 1A
M 3	20	BZ0933030020	5410439404013	40	3	BH1	Box 1A
M 4	10	BZ0933040010	5410439274630	70	3	BH1	Box 1A
M 4	12	BZ0933040012	5410439274647	65	3	BH1	Box 1A
M 4	16	BZ0933040016	5410439301602	60	3	BH1	Box 1A
M 4	20	BZ0933040020	5410439301619	55	3	BH1	Box 1A
M 4	25	BZ0933040025	5410439274654	50	3	BH1	Box 1A
M 4	30	BZ0933040030	5410439301626	45	3	BH1	Box 1A
M 5	10	BZ0933050010	5410439274685	48	3	BH1	Box 1A
M 5	12	BZ0933050012	5410439274678	46	3	BH1	Box 1A
M 5	16	BZ0933050016	5410439301640	44	3	BH1	Box 1A
M 5	20	BZ0933050020	5410439301657	42	3	BH1	Box 1A
M 5	25	BZ0933050025	5410439301664	40	3	BH1	Box 1A
M 5	30	BZ0933050030	5410439301671	36	3	BH1	Box 1A
M 5	40	BZ0933050040	5410439301688	33	3	BH1	Box 1A
M 6	10	BZ0933060010	5410439274692	37	3	BH1	Box 1A
M 6	12	BZ0933060012	5410439274661	35	3	BH1	Box 1A
M 6	16	BZ0933060016	5410439301695	33	3	BH1	Box 1A
M 6	20	BZ0933060020	5410439301701	29	3	BH1	Box 1A
M 6	25	BZ0933060025	5410439124959	50	3	BH3	Box 2A
M 6	30	BZ0933060030	5410439301718	27	3	BH1	Box 1A
M 6	35	BZ0933060035	5410439274708	25	3	BH1	Box 1A
M 6	40	BZ0933060040	5410439301725	22	3	BH1	Box 1A
M 6	45	BZ0933060045	5410439274715	20	3	BH1	Box 1A
M 6	50	BZ0933060050	5410439301732	19	3	BH1	Box 1A
M 6	60	BZ0933060060	5410439301749	17	3	BH1	Box 1A
M 6	70	BZ0933060070	5410439274722	16	3	BH1	Box 1A
M 6	80	BZ0933060080	5410439301756	15	3	BH1	Box 1A
M 8	10	BZ0933080010	5410439274739	19	3	BH1	Box 1A
M 8	12	BZ0933080012	5410439274746	19	3	BH1	Box 1A
M 8	16	BZ0933080016	5410439124966	17	3	BH1	Box 1A
M 8	20	BZ0933080020	5410439301800	17	3	BH1	Box 1A
M 8	25	BZ0933080025	5410439301817	15	3	BH1	Box 1A
M 8	30	BZ0933080030	5410439301824	14	3	BH1	Box 1A

BZ0933

8.8



Zeskantbout met moer DIN 933/934

Vis à tête hexagonal avec écrou DIN 933/934

Hexagonal screw with nut DIN 933/934

Sechskantschraube mit Mutter DIN 933/934

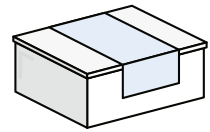

d [mm]	l [mm]	Art. ref.	EAN code			Price code	Packaging
M 8	35	BZ0933080035	5410439124973	12	3	BH1	Box 1A
M 8	40	BZ0933080040	5410439301831	12	3	BH1	Box 1A
M 8	50	BZ0933080050	5410439301848	9	3	BH1	Box 1A
M 8	60	BZ0933080060	5410439301855	8	3	BH1	Box 1A
M 8	70	BZ0933080070	5410439274753	8	3	BH1	Box 1A
M 8	80	BZ0933080080	5410439301862	7	3	BH1	Box 1A
M 10	16	BZ0933100016	5410439274760	25	3	BK1	Box 2A
M 10	20	BZ0933100020	5410439274777	25	3	BK1	Box 2A
M 10	25	BZ0933100025	5410439274784	25	1	BK1	Box 4A
M 10	30	BZ0933100030	5410439124980	25	1	BL1	Box 4A
M 10	35	BZ0933100035	5410439274791	25	1	BM1	Box 4A
M 10	40	BZ0933100040	5410439124997	25	1	BM1	Box 4A
M 10	45	BZ0933100045	5410439274807	25	1	BM1	Box 4A
M 10	50	BZ0933100050	5410439125000	25	1	BN1	Box 4A
M 10	60	BZ0933100060	5410439125017	25	1	BO1	Box 4A
M 10	70	BZ0933100070	5410439274814	20	1	BN1	Box 4A
M 10	80	BZ0933100080	5410439274821	20	1	BN1	Box 4A
M 10	90	BZ0933100090	5410439274838	15	1	BM1	Box 4A
M 10	100	BZ0933100100	5410439274845	10	1	BK1	Box 4A
M 12	20	BZ0933120020	5410439274852	30	1	BO1	Box 4A
M 12	25	BZ0933120025	5410439274869	30	1	BO1	Box 4A
M 12	30	BZ0933120030	5410439274876	30	1	BN1	Box 4A
M 12	35	BZ0933120035	5410439274883	25	1	BO1	Box 4A
M 12	40	BZ0933120040	5410439125024	25	1	BP1	Box 4A
M 12	45	BZ0933120045	5410439274890	20	1	BO1	Box 4A
M 12	50	BZ0933120050	5410439125031	20	1	BO1	Box 4A
M 12	55	BZ0933120055	5410439274906	20	1	BO1	Box 4A
M 12	60	BZ0933120060	5410439125048	20	1	BP1	Box 4A
M 12	70	BZ0933120070	5410439274913	15	1	BO1	Box 4A

BV1048



8.8



SB-bout met moer EN15048-1

Boulon SB avec écrou EN15048-1

SB-bolt with nut EN15048-1

SB-Schraube mit Mutter EN15048-1

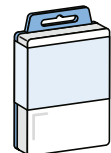

d [mm]	l [mm]	Art. ref.	EAN code			Price code	Packaging
M 10	20	BV1048100020	5410439046633	4	6	BC1	Blister B



BV1048



SB-bout met moer EN15048-1
 Boulon SB avec écrou EN15048-1
 SB-bolt with nut EN15048-1
 SB-Schraube mit Mutter EN15048-1



d [mm]	l [mm]	Art. ref.	EAN code			Price code	Packaging
M 10	25	BV1048100025	5410439046640	4	6	BC1	Blister B
M 10	30	BV1048100030	5410439046657	4	6	BC1	Blister B
M 10	35	BV1048100035	5410439046695	4	6	BC1	Blister B
M 10	40	BV1048100040	5410439046718	4	6	BC1	Blister B
M 10	45	BV1048100045	5410439046749	4	6	BC1	Blister B
M 10	50	BV1048100050	5410439046756	4	6	BD1	Blister B
M 12	25	BV1048120025	5410439046763	4	6	BD1	Blister B
M 12	30	BV1048120030	5410439046770	4	6	BD1	Blister B
M 12	35	BV1048120035	5410439046787	4	6	BD1	Blister B
M 12	40	BV1048120040	5410439046794	4	6	BE1	Blister B
M 16	30	BV1048160030	5410439046800	4	6	BJ1	Blister 2
M 16	50	BV1048160050	5410439046817	4	1	BJ1	Blister 2
M 20	60	BV1048200060	5410439046824	4	1	BN1	Blister H

METAALSCHROEVEN
VIS À MÉTAUX
MACHINE SCREWS
METALLSCHRAUBEN

BZ1084



Schroef met cilindrische kop DIN 7985/934

Vis à tête cylindrique DIN 7985/934

Cheese head screw DIN 7985/934

Zylinderkopfschraube DIN 7985/934



d [mm]	l [mm]	Art. ref.	EAN code			Price code	Packaging
M 3	10	BZ1084030010	5410439352505	23	12	BA1	Blister A
M 3	16	BZ1084030016	5410439352512	18	12	BA1	Blister A
M 3	20	BZ1084030020	5410439352529	18	12	BA1	Blister A
M 4	20	BZ1084040020	5410439352604	13	12	BA1	Blister A
M 4	25	BZ1084040025	5410439352611	12	12	BA1	Blister A
M 4	30	BZ1084040030	5410439352628	11	12	BA1	Blister A
M 4	40	BZ1084040040	5410439341912	9	12	BA1	Blister A
M 4	50	BZ1084040050	5410439341929	7	12	BA1	Blister A
M 4	60	BZ1084040060	5410439341936	5	12	BA1	Blister A
M 5	20	BZ1084050020	5410439352703	8	12	BA1	Blister A
M 5	25	BZ1084050025	5410439352710	7	12	BA1	Blister A
M 5	30	BZ1084050030	5410439352727	11	12	BB1	Blister A
M 5	40	BZ1084050040	5410439352734	9	12	BB1	Blister A
M 5	50	BZ1084050050	5410439341943	7	12	BB1	Blister A
M 5	60	BZ1084050060	5410439341950	5	12	BB1	Blister A
M 6	30	BZ1084060030	5410439352802	11	12	BC1	Blister A
M 6	40	BZ1084060040	5410439352819	7	12	BB1	Blister A
M 6	50	BZ1084060050	5410439352826	8	12	BC1	Blister A
M 6	60	BZ1084060060	5410439341967	6	12	BC1	Blister A

BZ0084



Schroef met cilindrische kop DIN 7985/934

Vis à tête cylindrique DIN 7985/934

Cheese head screw DIN 7985/934

Zylinderkopfschraube DIN 7985/934

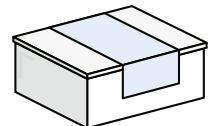

d [mm]	l [mm]	Art. ref.	EAN code			Price code	Packaging
M 3	10	BZ0084030010	5410439301206	100	3	BG1	Box 1A
M 3	16	BZ0084030016	5410439301213	100	3	BG1	Box 1A
M 3	20	BZ0084030020	5410439301220	75	3	BG1	Box 1A
M 4	16	BZ0084040016	5410439301251	90	3	BG1	Box 1A



BZ0084



Schroef met cilindrische kop DIN 7985/934
 Vis à tête cylindrique DIN 7985/934
 Cheese head screw DIN 7985/934
 Zylinderkopfschraube DIN 7985/934

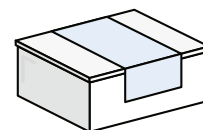

d [mm]	l [mm]	Art. ref.	EAN code			Price code	Packaging
M 4	20	BZ0084040020	5410439301268	75	3	BG1	Box 1A
M 4	30	BZ0084040030	5410439301275	60	3	BG1	Box 1A
M 4	40	BZ0084040040	5410439301282	50	3	BG1	Box 1A
M 5	20	BZ0084050020	5410439301305	52	3	BH1	Box 1A
M 5	30	BZ0084050030	5410439301312	43	3	BH1	Box 1A
M 5	40	BZ0084050040	5410439301329	33	3	BH1	Box 1A
M 5	50	BZ0084050050	5410439301336	31	3	BH1	Box 1A
M 6	20	BZ0084060020	5410439301350	34	3	BH1	Box 1A
M 6	30	BZ0084060030	5410439301367	28	3	BH1	Box 1A
M 6	40	BZ0084060040	5410439301374	24	3	BH1	Box 1A
M 6	50	BZ0084060050	5410439301381	20	3	BH1	Box 1A

BZ1963



Schroef met verzonken kop met moer DIN 965/934
 Vis à tête fraisée avec écrou DIN 965/934
 Countersunk head screw with nut DIN 965/934
 Senkkopfschraube mit Mutter DIN 965/934



d [mm]	l [mm]	Art. ref.	EAN code			Price code	Packaging
M 3	10	BZ1963030010	5410439352901	23	12	BA1	Blisters A
M 3	16	BZ1963030016	5410439352918	22	12	BA1	Blisters A
M 4	16	BZ1963040016	5410439353007	16	12	BA1	Blisters A
M 4	20	BZ1963040020	5410439353014	15	12	BA1	Blisters A
M 4	25	BZ1963040025	5410439353021	13	12	BA1	Blisters A
M 4	30	BZ1963040030	5410439353038	12	12	BA1	Blisters A
M 4	40	BZ1963040040	5410439341974	10	12	BA1	Blisters A
M 4	50	BZ1963040050	5410439341981	8	12	BA1	Blisters A
M 4	60	BZ1963040060	5410439341998	6	12	BA1	Blisters A
M 5	20	BZ1963050020	5410439353106	9	12	BA1	Blisters A
M 5	25	BZ1963050025	5410439353113	8	12	BA1	Blisters A
M 5	30	BZ1963050030	5410439353120	8	12	BA1	Blisters A
M 5	35	BZ1963050035	5410439353137	7	12	BA1	Blisters A
M 5	40	BZ1963050040	5410439353144	6	12	BA1	Blisters A
M 5	50	BZ1963050050	5410439342001	5	12	BA1	Blisters A
M 5	60	BZ1963050060	5410439342018	4	12	BA1	Blisters A
M 6	30	BZ1963060030	5410439353205	10	12	BB1	Blisters A
M 6	40	BZ1963060040	5410439353212	8	12	BB1	Blisters A
M 6	50	BZ1963060050	5410439353229	9	12	BC1	Blisters A



BZ1963



Schroef met verzonken kop met moer DIN 965/934
 Vis à tête fraisée avec écrou DIN 965/934
 Countersunk head screw with nut DIN 965/934
 Senkkopfschraube mit Mutter DIN 965/934

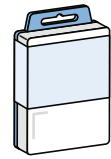

d [mm]	l [mm]	Art. ref.	EAN code			Price code	Packaging
M 6	60	BZ1963060060	5410439342025	7	12	BC1	Blister A

BZ0963



Schroef met verzonken kop met moer DIN 965/934
 Vis à tête fraisée avec écrou DIN 965/934
 Countersunk head screw with nut DIN 965/934
 Senkkopfschraube mit Mutter DIN 965/934

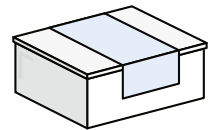

d [mm]	l [mm]	Art. ref.	EAN code			Price code	Packaging
M 3	10	BZ0963030010	5410439301404	100	3	BG1	Box 1A
M 3	16	BZ0963030016	5410439301411	100	3	BG1	Box 1A
M 3	20	BZ0963030020	5410439301428	100	3	BG1	Box 1A
M 4	16	BZ0963040016	5410439301459	90	3	BG1	Box 1A
M 4	20	BZ0963040020	5410439301466	90	3	BG1	Box 1A
M 4	30	BZ0963040030	5410439301473	70	3	BG1	Box 1A
M 4	40	BZ0963040040	5410439301480	50	3	BG1	Box 1A
M 5	20	BZ0963050020	5410439301503	52	3	BG1	Box 1A
M 5	30	BZ0963050030	5410439301510	47	3	BG1	Box 1A
M 5	40	BZ0963050040	5410439301527	32	3	BG1	Box 1A
M 5	50	BZ0963050050	5410439301534	26	3	BG1	Box 1A
M 6	16	BZ0963060016	5410439301541	38	3	BG1	Box 1A
M 6	20	BZ0963060020	5410439301558	37	3	BG1	Box 1A
M 6	30	BZ0963060030	5410439301565	28	3	BG1	Box 1A
M 6	40	BZ0963060040	5410439301572	24	3	BG1	Box 1A
M 6	50	BZ0963060050	5410439301589	18	3	BG1	Box 1A
M 6	60	BZ0963060060	5410439301596	14	3	BG1	Box 1A

BZ10VP



Schroef met dubbele gleuf
 Vis double fente
 Cross recessed mushroom head screw & nut
 Becherschraube doppel Schlitz

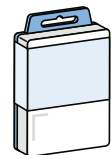

d [mm]	l [mm]	Art. ref.	EAN code			Price code	Packaging
M 4	16	BZ10VP040016	5410439103558	12	12	BB1	Blister A
M 4	20	BZ10VP040020	5410439103565	11	12	BB1	Blister A



BZ10VP



Schroef met dubbele gleuf
 Vis double fente
 Cross recessed mushroom head screw & nut
 Becherschraube doppel Schlitz



d [mm]	l [mm]	Art. ref.	EAN code			Price code	Packaging
M 4	25	BZ10VP040025	5410439127837	11	12	BB1	Blister A
M 4	30	BZ10VP040030	5410439103589	10	12	BB1	Blister A
M 4	40	BZ10VP040040	5410439103596	10	12	BB1	Blister A
M 4	50	BZ10VP040050	5410439103602	8	12	BB1	Blister A
M 5	20	BZ10VP050020	5410439103619	16	12	BC1	Blister A
M 5	25	BZ10VP050025	5410439103626	15	12	BC1	Blister A
M 5	30	BZ10VP050030	5410439103633	14	6	BC1	Blister B
M 5	40	BZ10VP050040	5410439103640	10	12	BC1	Blister A
M 5	50	BZ10VP050050	5410439103657	8	12	BC1	Blister A
M 6	40	BZ10VP060040	5410439103664	10	6	BC1	Blister B
M 6	50	BZ10VP060050	5410439103671	8	6	BC1	Blister B
M 6	60	BZ10VP060060	5410439103688	7	6	BC1	Blister B
M 8	30	BZ10VP080030	5410439103695	7	6	BC1	Blister B
M 8	40	BZ10VP080040	5410439103701	6	6	BC1	Blister B
M 8	50	BZ10VP080050	5410439103718	5	6	BC1	Blister B
M 8	60	BZ10VP080060	5410439103725	4	6	BC1	Blister B
M 8	80	BZ10VP080080	5410439120555	4	3	BC1	Blister E

BZ00VP



Schroef met dubbele gleuf
 Vis double fente
 Cross recessed mushroom head screw & nut
 Becherschraube doppel Schlitz

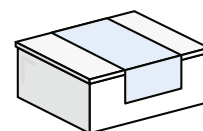

d [mm]	l [mm]	Art. ref.	EAN code			Price code	Packaging
M 4	16	BZ00VP040016	5410439329989	50	3	BB1	Box 1A
M 4	20	BZ00VP040020	5410439329996	50	3	BC1	Box 1A
M 4	25	BZ00VP040025	5410439330121	50	3	BC1	Box 1A
M 4	30	BZ00VP040030	5410439330138	50	3	BD1	Box 1A
M 4	40	BZ00VP040040	5410439330145	50	3	BE1	Box 1A
M 4	50	BZ00VP040050	5410439330152	50	3	BF1	Box 2A
M 5	20	BZ00VP050020	5410439330169	25	3	BC1	Box 1A
M 5	25	BZ00VP050025	5410439330176	25	3	BC1	Box 1A
M 5	30	BZ00VP050030	5410439330183	25	3	BD1	Box 1A
M 5	40	BZ00VP050040	5410439330190	25	3	BD1	Box 1A
M 5	50	BZ00VP050050	5410439330206	25	3	BE1	Box 1A
M 6	40	BZ00VP060040	5410439330213	25	3	BG1	Box 1A
M 6	50	BZ00VP060050	5410439330220	25	3	BF1	Box 2A





BZ00VP

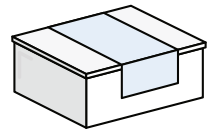

Schroef met dubbele gleuf
 Vis double fente
 Cross recessed mushroom head screw & nut
 Becherschraube doppel Schlitz





d [mm]	l [mm]	Art. ref.	EAN code			Price code	Packaging
M 6	60	BZ00VP060060	5410439330237	25	3	BG1	Box 2A
M 8	30	BZ00VP080030	5410439330244	20	3	BH1	Box 2A
M 8	40	BZ00VP080040	5410439330251	20	3	BH3	Box 2A
M 8	50	BZ00VP080050	5410439330268	20	1	BI1	Box 3A
M 8	60	BZ00VP080060	5410439330275	20	1	BJ1	Box 3A
M 8	80	BZ00VP080080	5410439330282	20	1	BK1	Box 4A

BINNENZSKANTSSCHROEVEN
VIS À SIX PANS CREUX
SOCKET SCREWS
INNENSECHSKANTSCHRAUBEN

BZ1912

Binnenzskantbout met cilindrische kop DIN 912
 Vis à six pans creux avec tête cylindrique DIN 912
 Socket cap screw DIN 912
 Innensechskantschraube DIN 912



d [mm]	l [mm]	Art. ref.	EAN code			Price code	Packaging
M 4	6	BZ1912040006	5410439274999	14	12	BE1	Blister A
M 4	8	BZ1912040008	5410439274982	14	12	BE1	Blister A
M 4	10	BZ1912040010	5410439274975	14	12	BE1	Blister A
M 4	12	BZ1912040012	5410439274968	12	12	BE1	Blister A
M 4	16	BZ1912040016	5410439385015	12	12	BE1	Blister A
M 4	20	BZ1912040020	5410439385022	11	12	BE1	Blister A
M 4	25	BZ1912040025	5410439274951	10	12	BE1	Blister A
M 4	30	BZ1912040030	5410439385039	10	12	BE1	Blister A
M 4	35	BZ1912040035	5410439274944	8	12	BE1	Blister A
M 4	40	BZ1912040040	5410439341837	8	12	BE1	Blister A
M 4	50	BZ1912040050	5410439341844	6	12	BE1	Blister A
M 4	60	BZ1912040060	5410439341851	4	12	BE1	Blister A
M 5	8	BZ1912050008	5410439275057	12	12	BF1	Blister A
M 5	10	BZ1912050010	5410439275040	19	12	BF1	Blister A
M 5	12	BZ1912050012	5410439275033	18	12	BF1	Blister A
M 5	16	BZ1912050016	5410439385114	17	12	BF1	Blister A
M 5	20	BZ1912050020	5410439385121	16	12	BF1	Blister A
M 5	25	BZ1912050025	5410439275026	15	12	BF1	Blister A
M 5	30	BZ1912050030	5410439385138	14	12	BF1	Blister A
M 5	35	BZ1912050035	5410439275019	13	12	BF1	Blister A
M 5	40	BZ1912050040	5410439341868	12	12	BF1	Blister A
M 5	45	BZ1912050045	5410439275002	11	12	BF1	Blister A
M 5	50	BZ1912050050	5410439341875	10	12	BF1	Blister A
M 5	60	BZ1912050060	5410439341882	8	12	BF1	Blister A
M 6	10	BZ1912060010	5410439275118	12	12	BF1	Blister A
M 6	12	BZ1912060012	5410439275101	12	12	BF1	Blister A
M 6	16	BZ1912060016	5410439385213	15	12	BF1	Blister A
M 6	20	BZ1912060020	5410439385220	14	12	BF1	Blister A
M 6	25	BZ1912060025	5410439275095	13	12	BF1	Blister A
M 6	30	BZ1912060030	5410439385237	12	12	BF1	Blister A
M 6	35	BZ1912060035	5410439275088	11	12	BF1	Blister A
M 6	40	BZ1912060040	5410439385244	10	12	BF1	Blister A
M 6	45	BZ1912060045	5410439275071	9	12	BF1	Blister A

BZ1912

8.8



Binnenzeskantbout met cilindrische kop DIN 912
 Vis à six pans creux avec tête cylindrique DIN 912
 Socket cap screw DIN 912
 Innensechskantschraube DIN 912

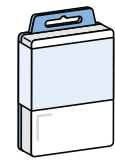

d [mm]	l [mm]	Art. ref.	EAN code			Price code	Packaging
M 6	50	BZ1912060050	5410439341899	8	12	BF1	Blister A
M 6	55	BZ1912060055	5410439275064	7	12	BF1	Blister A
M 6	60	BZ1912060060	5410439341905	6	12	BF1	Blister A
M 8	10	BZ1912080010	5410439275163	9	6	BF1	Blister B
M 8	12	BZ1912080012	5410439275156	9	6	BF1	Blister B
M 8	16	BZ1912080016	5410439275149	8	6	BF1	Blister B
M 8	20	BZ1912080020	5410439385312	8	6	BF1	Blister B
M 8	25	BZ1912080025	5410439275132	7	6	BF1	Blister B
M 8	30	BZ1912080030	5410439385329	7	6	BF1	Blister B
M 8	35	BZ1912080035	5410439275125	6	6	BF1	Blister B
M 8	40	BZ1912080040	5410439385336	6	6	BF1	Blister B
M 8	45	BZ1912080045	5410439275170	6	6	BF1	Blister B
M 8	50	BZ1912080050	5410439275187	6	6	BF1	Blister B
M 8	60	BZ1912080060	5410439275194	6	6	BF1	Blister B
M 8	65	BZ1912080065	5410439275200	6	6	BF1	Blister B
M 8	70	BZ1912080070	5410439275217	6	6	BF1	Blister B
M 8	80	BZ1912080080	5410439275224	6	3	BF1	Blister E
M 8	90	BZ1912080090	5410439275231	6	6	BF1	Blister B
M 10	20	BZ1912100020	5410439275279	8	6	BH1	Blister B
M 10	25	BZ1912100025	5410439275262	7	6	BH1	Blister B
M 10	30	BZ1912100030	5410439385411	7	6	BH1	Blister B
M 10	35	BZ1912100035	5410439275255	6	6	BH1	Blister B
M 10	40	BZ1912100040	5410439385428	6	6	BH1	Blister B
M 10	45	BZ1912100045	5410439275248	5	6	BH1	Blister B
M 10	50	BZ1912100050	5410439385435	5	6	BH1	Blister B
M 10	60	BZ1912100060	5410439275286	4	6	BH1	Blister B
M 10	70	BZ1912100070	5410439275293	4	3	BH1	Blister E

BZ1916

45
H

Binnenzeskantsstelschroef DIN 916
 Vis à 6 pans creux DIN 916
 Hexagon socket screw DIN 916
 Gewindestifte DIN 916





d [mm]	l [mm]	Art. ref.	EAN code			Price code	Packaging
M 3	5	BZ1916030005	5410439436779	20	12	BE1	Blister A
M 3	6	BZ1916030006	5410439436786	20	12	BE1	Blister A
M 4	5	BZ1916040005	5410439436793	20	12	BE1	Blister A

BZ1916



Binnenzeskantsstelschroef DIN 916
 Vis à 6 pans creux DIN 916
 Hexagonalsocket screw DIN 916
 Gewindestifte DIN 916





d [mm]	l [mm]	Art. ref.	EAN code			Price code	Packaging
M 4	10	BZ1916040010	5410439436809	16	12	BD1	Blister A
M 4	16	BZ1916040016	5410439436816	16	12	BD1	Blister A
M 5	6	BZ1916050006	5410439686167	10	12	BC1	Blister A
M 5	10	BZ1916050010	5410439436830	16	12	BD1	Blister A
M 5	16	BZ1916050016	5410439436823	16	12	BE1	Blister A
M 6	6	BZ1916060006	5410439686174	10	12	BC1	Blister A
M 6	16	BZ1916060016	5410439436847	10	12	BC1	Blister A
M 8	10	BZ1916080010	5410439436854	10	12	BD1	Blister A
M 10	12	BZ1916100012	5410439436861	10	12	BD1	Blister A

BZ1991



Binnenzeskantbout met verzonken kop DIN 7991
 Vis à 6 pans creux DIN 7991
 Countersunk screw DIN 7991
 Senkschraube DIN 7991



d [mm]	l [mm]	Art. ref.	EAN code			Price code	Packaging
M 4	16	BZ1991040016	5410439395014	12	12	BF1	Blister A
M 4	20	BZ1991040020	5410439395021	11	12	BF1	Blister A
M 4	30	BZ1991040030	5410439395038	10	12	BF1	Blister A
M 4	40	BZ1991040040	5410439342032	8	12	BF1	Blister A
M 4	50	BZ1991040050	5410439342049	7	12	BF1	Blister A
M 4	60	BZ1991040060	5410439342056	6	12	BF1	Blister A
M 5	16	BZ1991050016	5410439395113	17	12	BG1	Blister A
M 5	20	BZ1991050020	5410439395120	16	12	BG1	Blister A
M 5	30	BZ1991050030	5410439395137	14	12	BG1	Blister A
M 5	40	BZ1991050040	5410439342063	12	12	BG1	Blister A
M 5	50	BZ1991050050	5410439342070	10	12	BG1	Blister A
M 5	60	BZ1991050060	5410439342087	8	12	BG1	Blister A
M 6	16	BZ1991060016	5410439395212	15	12	BG1	Blister A
M 6	20	BZ1991060020	5410439395229	14	12	BG1	Blister A
M 6	30	BZ1991060030	5410439395236	12	12	BG1	Blister A
M 6	40	BZ1991060040	5410439395243	10	12	BG1	Blister A
M 6	50	BZ1991060050	5410439342094	8	12	BG1	Blister A
M 6	60	BZ1991060060	5410439342100	6	12	BG1	Blister A
M 8	20	BZ1991080020	5410439395311	8	6	BG1	Blister B
M 8	30	BZ1991080030	5410439395328	7	6	BG1	Blister B
M 8	40	BZ1991080040	5410439395335	6	6	BG1	Blister B





BZ1991

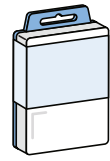

Binnenzeskantbout met verzonken kop DIN 7991
 Vis à 6 pans creux DIN 7991
 Countersunk screw DIN 7991
 Senkschraube DIN 7991



d [mm]	l [mm]	Art. ref.	EAN code			Price code	Packaging
M 10	30	BZ1991100030	5410439395410	5	6	BI1	Blister B
M 10	40	BZ1991100040	5410439395427	4	6	BI1	Blister B
M 10	50	BZ1991100050	5410439395434	3	6	BI1	Blister B

DIVERSE KOPVORMEN
TÊTES DIFFÉRENTES
VARIOUS HEAD FORMS
VERSCHIEDENE KÖPFE



BZ1316



Vleugelbout gietijzer DIN 316
Boulon à ailette font DIN 316
Wing bolt DIN 316
Flügelschraube DIN 316

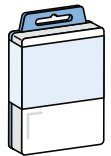

d [mm]	l [mm]	Art. ref.	EAN code			Price code	Packaging
M 4	20	BZ1316040020	5410439354905	6	12	BH3	Blister A
M 5	20	BZ1316050020	5410439354912	5	12	BH3	Blister A
M 6	20	BZ1316060020	5410439354929	4	6	BH3	Blister B
M 8	25	BZ1316080025	5410439354936	3	6	BH3	Blister B
M 10	30	BZ1316100030	5410439354943	2	6	BH3	Blister B



BZ1MSH



Metrische schroefhaak & moer
Crochet d'armoire métrique & écrou
Metric cup hooks & nut
Gebogene Schraubhaken metrisch & Mutter

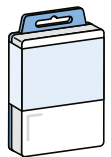

d [mm]	l [mm]	Art. ref.	EAN code			Price code	Packaging
M 4	50	BZ1MSH040050	5410439350600	3	12	BC1	Blister A
M 5	50	BZ1MSH050050	5410439350617	3	12	BC1	Blister A
M 6	60	BZ1MSH060060	5410439350624	2	12	BC1	Blister A
M 8	60	BZ1MSH080060	5410439350631	2	12	BE1	Blister A



BZ1MSO



Metrisch schroefoog & moer
Piton fermé métrique & écrou
Metric screw eye thread & nut
Ringschraube metrisch & mutter

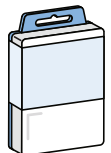

d [mm]	l [mm]	Art. ref.	EAN code			Price code	Packaging
M 4	30	BZ1MSO040030	5410439350501	3	12	BB1	Blister A
M 5	40	BZ1MSO050040	5410439350518	3	12	BB1	Blister A
M 6	50	BZ1MSO060050	5410439350525	2	12	BB1	Blister A
M 6	60	BZ1MSO060060	5410439350532	2	12	BB1	Blister A

ZONDER KOP
SANS TÊTE
SCREWS WITHOUT HEAD
OHNE KOPF

BZ1976



Draadstang DIN 976 met 2 sluitringen en 4 moeren
Tige filetée DIN 976 avec 2 rondelles et 4 écrous
Threaded rod DIN 976 with 2 washers and 4 nuts
Gewindestange DIN 976 mit 2 Scheiben und 4 Muttern

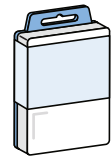

d [mm]	l [mm]	Art. ref.	EAN code			Price code	Packaging
M 4	200	BZ1976040200	5410439361040	2	1	BH3	Blister G
M 5	200	BZ1976050200	5410439360609	2	1	BI1	Blister G
M 6	200	BZ1976060200	5410439361064	2	1	BG1	Blister G
M 8	200	BZ1976080200	5410439361095	2	1	BH1	Blister G
M 10	200	BZ1976100200	5410439361101	2	1	BJ1	Blister G
M 12	200	BZ1976120200	5410439361125	2	1	BJ1	Blister G

BZ10SE



Stokeind
Goujon à 2 filets
Hanger bolt
Stockschraube

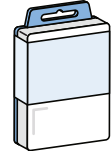

d [mm]	l [mm]	Art. ref.	EAN code			Price code	Packaging
M 4	40	BZ10SE040040	5410439202787	4	12	BB1	Blister A
M 5	50	BZ10SE050050	5410439202909	4	12	BB1	Blister A
M 6	40	BZ10SE060040	5410439202916	4	12	BB1	Blister A
M 6	50	BZ10SE060050	5410439202923	4	12	BB1	Blister A
M 6	60	BZ10SE060060	5410439202930	4	12	BC1	Blister A
M 6	80	BZ10SE060080	5410439202947	4	6	BC1	Blister B
M 8	50	BZ10SE080050	5410439202954	4	12	BC1	Blister A
M 8	60	BZ10SE080060	5410439202961	4	12	BC1	Blister A
M 8	70	BZ10SE080070	5410439202978	4	3	BE1	Blister E
M 8	80	BZ10SE080080	5410439202985	4	3	BE1	Blister E
M 8	100	BZ10SE080100	5410439202992	4	3	BE1	Blister E
M 10	60	BZ10SE100060	5410439203005	4	6	BE1	Blister B
M 10	70	BZ10SE100070	5410439203012	4	3	BF1	Blister E
M 10	80	BZ10SE100080	5410439203029	4	3	BF1	Blister E
M 10	100	BZ10SE100100	5410439203036	4	3	BF1	Blister E
M 10	120	BZ10SE100120	5410439203043	4	3	BG1	Blister E





BZ1SEB

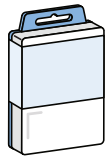

Stokeind met borst
 Vis à bois à embase
 Hangerbolt with shoulder
 Ansatzschraube



d [mm]	l [mm]	Art. ref.	EAN code			Price code	Packaging
M 7	40	BZ1SEB070040	5410439271493	4	12	BB1	Blister A
M 7	50	BZ1SEB070050	5410439271509	4	12	BB1	Blister A
M 7	60	BZ1SEB070060	5410439271516	4	12	BC1	Blister A
M 7	70	BZ1SEB070070	5410439271523	4	3	BE1	Blister E

MOEREN
ÉCROUS
NUTS
MUTTERN

BZ1439

4



Lage zeskantmoer DIN 439B
Ecrou hexagonal bas DIN 439B
Thin hexagon nut DIN 439B
Sechskantmutter DIN 439B

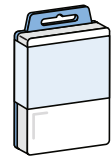

d [mm]	Art. ref.	EAN code			Price code	Packaging
M 4	BZ1439040000	5410439437011	30	12	BB1	Blister A
M 5	BZ1439050000	5410439437028	25	12	BB1	Blister A
M 6	BZ1439060000	5410439437035	22	12	BB1	Blister A
M 8	BZ1439080000	5410439437042	13	12	BB1	Blister A
M 10	BZ1439100000	5410439437059	7	12	BC1	Blister A
M 12	BZ1439120000	5410439437066	5	12	BC1	Blister A
M 16	BZ1439160000	5410439437073	7	6	BE1	Blister B
M 20	BZ1439200000	5410439437080	4	6	BE1	Blister B

BZ1934

|8|



Zeskantmoer DIN 934
Ecrou hexagonal DIN 934
Hexagon nut DIN 934
Sechskantmutter DIN 934



d [mm]	Art. ref.	EAN code			Price code	Packaging
M 3	BZ1934030000	5410439354509	35	12	BA1	Blister A
M 4	BZ1934040000	5410439354516	30	12	BA1	Blister A
M 5	BZ1934050000	5410439354523	25	12	BA1	Blister A
M 6	BZ1934060000	5410439354530	22	12	BA1	Blister A
M 7	BZ1934070000	5410439640466	15	12	BA1	Blister A
M 8	BZ1934080000	5410439354547	13	12	BA1	Blister A
M 10	BZ1934100000	5410439354554	7	12	BA1	Blister A
M 12	BZ1934120000	5410439354561	5	12	BA1	Blister A
M 14	BZ1934140000	5410439354578	3	6	BA1	Blister B
M 16	BZ1934160000	5410439354585	6	3	BD1	Blister E
M 18	BZ1934180000	5410439124539	4	3	BE1	Blister E
M 20	BZ1934200000	5410439124522	4	3	BF1	Blister E





BZ0934

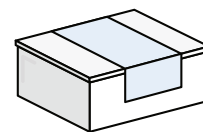

Zeskantmoer DIN 934
 Ecrou hexagonal DIN 934
 Hexagon nut DIN 934
 Sechskantmutter DIN 934





d [mm]	Art. ref.	EAN code			Price code	Packaging
M 3	BZ0934030000	5410439302555	200	3	BE1	Box 1A
M 4	BZ0934040000	5410439302562	200	3	BE1	Box 1A
M 5	BZ0934050000	5410439302579	100	3	BD1	Box 1A
M 6	BZ0934060000	5410439302586	100	3	BE1	Box 1A
M 8	BZ0934080000	5410439302593	75	3	BG1	Box 1A
M 10	BZ0934100000	5410439302609	35	3	BG1	Box 2A
M 12	BZ0934120000	5410439302616	22	3	BG1	Box 2A
M 14	BZ0934140000	5410439302623	10	3	BE1	Box 1A
M 16	BZ0934160000	5410439302630	9	3	BE1	Box 2A
M 18	BZ0934180000	5410439302647	5	3	BE1	Box 1A
M 20	BZ0934200000	5410439302654	5	3	BF1	Box 1A

BM1934



Zeskantmoer DIN 934
 Ecrou hexagonal DIN 934
 Hexagonal nut DIN 934
 Sechskantmutter DIN 934





d [mm]	Art. ref.	EAN code			Price code	Packaging
M 3	BM1934030000	5410439436939	10	12	BB1	Blister A
M 4	BM1934040000	5410439436878	10	12	BB1	Blister A
M 5	BM1934050000	5410439436885	10	12	BC1	Blister A
M 6	BM1934060000	5410439436892	10	12	BD1	Blister A
M 8	BM1934080000	5410439436908	10	12	BE1	Blister A
M 10	BM1934100000	5410439436915	6	12	BF1	Blister A
M 12	BM1934120000	5410439436922	4	12	BH1	Blister A

BZ1334



Hoge zeskantmoer DIN 6334
 Ecrou hexagonal haut DIN 6334
 High hexagon nut DIN 6334
 Hohe Sechskantmutter DIN 6334



d [mm]	l [mm]	Art. ref.	EAN code			Price code	Packaging
M 6	18	BZ1334060018	5410439202794	4	12	BD1	Blister A
M 8	24	BZ1334080024	5410439203050	4	6	BG1	Blister B

BZ1334

5



Hoge zeskantmoer DIN 6334
 Ecrou hexagonal haut DIN 6334
 High hexagon nut DIN 6334
 Hohe Sechskantmutter DIN 6334



d [mm]	l [mm]	Art. ref.	EAN code			Price code	Packaging
M 10	30	BZ1334100030	5410439203067	4	6	BJ1	Blister B
M 12	36	BZ1334120036	5410439203074	4	6	BL1	Blister B

BZ1985

6



Borgmoer DIN 985
 Ecrou de sécurité DIN 985
 Hexagonal selflocking nut DIN 985
 Sechskantmutter DIN 985

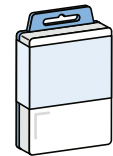

d [mm]	Art. ref.	EAN code			Price code	Packaging
M 3	BZ1985030000	5410439354707	14	12	BA1	Blister A
M 4	BZ1985040000	5410439354714	12	12	BA1	Blister A
M 5	BZ1985050000	5410439354721	10	12	BA1	Blister A
M 6	BZ1985060000	5410439354738	8	12	BA1	Blister A
M 8	BZ1985080000	5410439354745	7	12	BA1	Blister A
M 10	BZ1985100000	5410439354752	5	12	BA1	Blister A
M 12	BZ1985120000	5410439354769	4	12	BB1	Blister A
M 14	BZ1985140000	5410439354776	5	6	BC1	Blister B
M 16	BZ1985160000	5410439354783	5	6	BD1	Blister B

BZ0985

6



Borgmoer DIN 985
 Ecrou de sécurité DIN 985
 Hexagonal selflocking nut DIN 985
 Sechskantmutter DIN 985

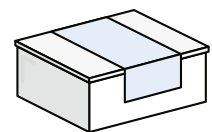

d [mm]	Art. ref.	EAN code			Price code	Packaging
M 3	BZ0985030000	5410439302708	100	3	BF1	Box 1A
M 4	BZ0985040000	5410439302715	100	3	BF1	Box 1A
M 5	BZ0985050000	5410439302722	85	3	BE1	Box 1A
M 6	BZ0985060000	5410439302739	80	3	BF1	Box 1A
M 8	BZ0985080000	5410439302753	45	3	BF1	Box 1A
M 10	BZ0985100000	5410439302760	22	3	BF1	Box 1A
M 12	BZ0985120000	5410439302777	19	3	BG1	Box 1A
M 14	BZ0985140000	5410439337465	16	3	BG1	Box 2A
M 16	BZ0985160000	5410439337472	10	3	BF1	Box 2A



BZ10IM



Inslagmoer voor hout
 Ecrou à enfoncer à griffes
 Pronged T-nut
 Einschlagmutter 4 Spitzen

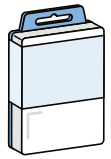

d [mm]	l [mm]	Art. ref.	EAN code			Price code	Packaging
M 4	6	BZ10IM040006	5410439202800	4	12	BC1	Blister A
M 5	8	BZ10IM050008	5410439203081	4	12	BC1	Blister A
M 6	9	BZ10IM060009	5410439203098	4	12	BC1	Blister A
M 8	11	BZ10IM080011	5410439203104	4	12	BC1	Blister A
M 10	13	BZ10IM100013	5410439404204	4	6	BD1	Blister B



BZ00IM



Inslagmoer voor hout
 Ecrou à enfoncer à griffes
 Pronged T-nut
 Einschlagmutter 4 Spitzen

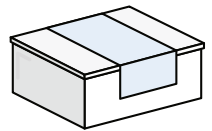

d [mm]	l [mm]	Art. ref.	EAN code			Price code	Packaging
M 4	6	BZ00IM040006	5410439329941	50	3	BH1	Box 1A
M 5	8	BZ00IM050008	5410439329958	50	3	BH3	Box 1A
M 6	9	BZ00IM060009	5410439329965	50	3	BI1	Box 2A
M 8	11	BZ00IM080011	5410439329972	50	3	BJ1	Box 2A



BZ1315



Vleugelmoer gietijzer DIN 315
 Ecrou à ailettes fonte DIN 315
 Wing nut DIN 315
 Flügelmutter DIN 315

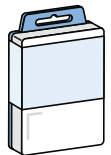

d [mm]	Art. ref.	EAN code			Price code	Packaging
M 4	BZ1315040000	5410439354806	6	12	BB1	Blister A
M 5	BZ1315050000	5410439354813	5	12	BB1	Blister A
M 6	BZ1315060000	5410439354820	4	12	BB1	Blister A
M 8	BZ1315080000	5410439354837	3	6	BB1	Blister B
M 10	BZ1315100000	5410439354844	2	6	BB1	Blister B
M 12	BZ1315120000	5410439354851	1	6	BB1	Blister B



BZ1587



Dopmoer DIN 1587
 Ecrou borgne DIN 1587
 Acorn nut DIN 1587
 Hutmutter DIN 1587

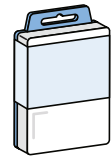

d [mm]	Art. ref.	EAN code			Price code	Packaging
M 4	BZ1587040000	5410439355001	7	12	BB1	Blister A
M 5	BZ1587050000	5410439355018	6	12	BB1	Blister A
M 6	BZ1587060000	5410439355025	5	12	BB1	Blister A
M 8	BZ1587080000	5410439355032	3	12	BB1	Blister A
M 10	BZ1587100000	5410439355049	2	6	BB1	Blister B
M 12	BZ1587120000	5410439337489	2	6	BB1	Blister B

BZ1796



Insertmoer DIN 7965A
 Ecrou à visser DIN 7965A
 Screwed insert DIN 7965A
 Einschraubmutter DIN 7965A

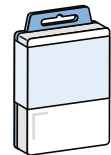

d [mm]	l [mm]	Art. ref.	EAN code			Price code	Packaging
M 4	10	BZ1796040010	5410439437097	4	12	BD1	Blister A
M 5	12	BZ1796050012	5410439437103	4	12	BE1	Blister A
M 6	15	BZ1796060015	5410439437110	4	12	BF1	Blister A
M 8	18	BZ1796080018	5410439437127	4	6	BJ1	Blister B
M 10	25	BZ1796100025	5410439437134	4	6	BO1	Blister B

BZ0796



Insertmoer DIN 7965A
 Ecrou à visser DIN 7965A
 Screwed insert DIN 7965A
 Einschraubmutter DIN 7965A

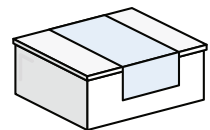

d [mm]	l [mm]	Art. ref.	EAN code			Price code	Packaging
M 4	10	BZ0796040010	5410439342209	20	3	BJ1	Box 1A
M 5	12	BZ0796050012	5410439342216	20	3	BM1	Box 1A
M 6	15	BZ0796060015	5410439342223	20	3	BN1	Box 1A
M 8	18	BZ0796080018	5410439342230	20	3	BQ1	Box 1A
M 10	25	BZ0796100025	5410439342247	20	3	BY1	Box 2A



BK0AFD



Afdekkap voor zeskantmoer
Cache-écrou hexagonal
Cap for hexagonal nut
Sechskantschutzkappen

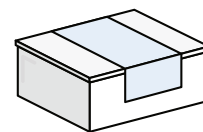

d [mm]	Art. ref.	EAN code	Colour			Price code	Packaging
SW 10	BK0AFD040601	5410439342254	Black	10	3	BB1	Box 1A
SW 10	BK0AFD040608	5410439342681	White	10	3	BB1	Box 1A
SW 13	BK0AFD040801	5410439342261	Black	10	3	BB1	Box 1A
SW 13	BK0AFD040808	5410439342674	White	10	3	BB1	Box 1A
SW 17	BK0AFD041001	5410439342650	Black	10	3	BD1	Box 1A
SW 17	BK0AFD041008	5410439342667	White	10	3	BD1	Box 1A

BV1032

8



Zeskantmoer ISO 4032
Ecrou hexagonal ISO 4032
Hexagon nut ISO 4032
Sechskantmutter ISO 4032



d [mm]	Art. ref.	EAN code			Price code	Packaging
M 10	BV1032100000	5410439046978	8	12	BA1	Blister A
M 12	BV1032120000	5410439046992	8	12	BB1	Blister A
M 16	BV1032160000	5410439047012	2	6	BA1	Blister B
M 20	BV1032200000	5410439047036	2	6	BC1	Blister B



SLUITRINGEN
RONDELLES
WASHERS
SCHEIBEN

BZ1125

140
HVZ
Zinc plated

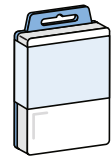
Sluitring DIN 125A
Rondelle DIN 125A
Flat washer DIN 125A
Scheibe DIN 125A





d [mm]	d _e [mm]	Art. ref.	EAN code			Price code	Packaging
M 3	7	BZ1125030000	5410439354301	50	12	BA1	Blister A
M 4	9	BZ1125040000	5410439354318	40	12	BA1	Blister A
M 5	10	BZ1125050000	5410439354325	35	12	BA1	Blister A
M 6	12	BZ1125060000	5410439354332	30	12	BA1	Blister A
M 7	14	BZ1125070000	5410439269070	22	12	BA1	Blister A
M 8	16	BZ1125080000	5410439354349	20	12	BA1	Blister A
M 10	20	BZ1125100000	5410439354356	12	12	BA1	Blister A
M 12	24	BZ1125120000	5410439354363	7	12	BA1	Blister A
M 14	28	BZ1125140000	5410439354370	6	12	BA1	Blister A
M 16	30	BZ1125160000	5410439354387	5	12	BA1	Blister A
M 18	34	BZ1125180000	5410439354394	4	12	BA1	Blister A
M 20	37	BZ1125200000	5410439354400	3	12	BA1	Blister A

BZ0125

140
HVZ
Zinc plated

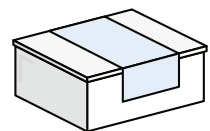
Sluitring DIN 125A
Rondelle DIN 125A
Flat washer DIN 125A
Scheibe DIN 125A



d [mm]	d _e [mm]	Art. ref.	EAN code			Price code	Packaging
M 3	7	BZ0125030000	5410439302401	200	3	BC1	Box 1A
M 4	9	BZ0125040000	5410439302418	200	3	BC1	Box 1A
M 5	10	BZ0125050000	5410439302425	150	3	BC1	Box 1A
M 6	12	BZ0125060000	5410439302432	100	3	BD1	Box 1A
M 8	16	BZ0125080000	5410439302449	100	3	BE1	Box 1A
M 10	20	BZ0125100000	5410439302456	75	3	BF1	Box 1A
M 12	24	BZ0125120000	5410439302463	45	3	BG1	Box 1A
M 14	28	BZ0125140000	5410439302470	30	3	BG1	Box 1A
M 16	30	BZ0125160000	5410439302487	25	3	BG1	Box 1A
M 18	34	BZ0125180000	5410439302494	20	3	BH1	Box 1A
M 20	37	BZ0125200000	5410439302807	15	3	BF1	Box 1A



BM1125



Sluitring DIN 125A
Rondelle DIN 125A
Flat washer DIN 125A
Scheibe DIN 125A



d [mm]	d _e [mm]	Art. ref.	EAN code			Price code	Packaging
M 3	7	BM1125030000	5410439436946	30	12	BB1	Blister A
M 4	9	BM1125040000	5410439436953	30	12	BC1	Blister A
M 5	10	BM1125050000	5410439436960	30	12	BD1	Blister A
M 6	12	BM1125060000	5410439436977	30	12	BF1	Blister A
M 8	16	BM1125080000	5410439436984	25	12	BH1	Blister A
M 10	20	BM1125100000	5410439436991	15	12	BH3	Blister A
M 12	24	BM1125120000	5410439437004	10	12	BK1	Blister A

BZ1021



Carrosseriesluitring DIN 9021
Rondelle carrosserie DIN 9021
Mudguard washer DIN 9021
Kotflügelscheibe DIN 9021





d [mm]	d _e [mm]	l [mm]	Art. ref.	EAN code			Price code	Packaging
M 4	12	12	BZ1021040012	5410439361989	24	12	BA1	Blister A
M 5	15	15	BZ1021050015	5410439354202	22	12	BA1	Blister A
M 5	15	20	BZ1021050020	5410439402507	14	12	BA1	Blister A
M 6	18	18	BZ1021060018	5410439354219	18	12	BA1	Blister A
M 6	18	25	BZ1021060025	5410439402514	11	12	BA1	Blister A
M 6	18	30	BZ1021060030	5410439402545	8	12	BA1	Blister A
M 8	24	20	BZ1021080020	5410439354226	8	12	BA1	Blister A
M 8	24	24	BZ1021080025	5410439402521	8	12	BA1	Blister A
M 8	24	30	BZ1021080030	5410439402750	8	12	BA1	Blister A
M 8	24	36	BZ1021080036	5410439402552	8	12	BB1	Blister A
M 10	30	30	BZ1021100030	5410439354233	5	12	BA1	Blister A
M 10	30	36	BZ1021100036	5410439402538	4	12	BA1	Blister A
M 12	37	37	BZ1021120037	5410439354240	4	12	BA1	Blister A
M 14	44	40	BZ1021140040	5410439354257	4	12	BA1	Blister A

BZ0021

140
HVZ
Zinc plated

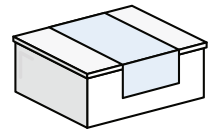
Carrosseriesluitring DIN 9021
Rondelle carrosserie DIN 9021
Mudguard washer DIN 9021
Kotflügelscheibe DIN 9021





d [mm]	d _e [mm]	l [mm]	Art. ref.	EAN code			Price code	Packaging
M 5	15	15	BZ0021050015	5410439302302	100	3	BE1	Box 1A
M 5	15	20	BZ0021050020	5410439302364	70	3	BH1	Box 1A
M 6	18	18	BZ0021060018	5410439302319	90	3	BF1	Box 1A
M 6	18	25	BZ0021060025	5410439302371	55	3	BH1	Box 1A
M 6	18	30	BZ0021060030	5410439302906	40	3	BH1	Box 1A
M 8	24	20	BZ0021080020	5410439123358	45	3	BF1	Box 1A
M 8	24	25	BZ0021080025	5410439302388	45	3	BF1	Box 1A
M 8	24	30	BZ0021080030	5410439302920	40	3	BG1	Box 2A
M 8	24	36	BZ0021080036	5410439302913	35	3	BH3	Box 2A
M 10	30	30	BZ0021100030	5410439302333	25	3	BG1	Box 1A
M 10	30	36	BZ0021100036	5410439302395	20	3	BF1	Box 1A
M 12	37	37	BZ0021120037	5410439302340	10	3	BE1	Box 1A
M 14	44	44	BZ0021140040	5410439302357	8	3	BD1	Box 1A
M 16	50	50	BZ0021160050	5410439337397	6	3	BD1	Box 1A
M 18	56	55	BZ0021180055	5410439337403	4	3	BD1	Box 1A
M 20	60	60	BZ0021200060	5410439337410	2	3	BC1	Box 1A

BV1089

200
HVVV
Hot dip
galvanised

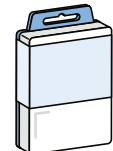
Sluitring EN ISO 7089
Rondelle EN ISO 7089
Washer EN ISO 7089
Scheibe EN ISO 7089



d [mm]	d _e [mm]	Art. ref.	EAN code			Price code	Packaging
M 10	20	BV1089100000	5410439047050	8	12	BA1	Blister A
M 12	24	BV1089120000	5410439046602	8	12	BA1	Blister A
M 16	30	BV1089160000	5410439046626	4	12	BA1	Blister A
M 20	37	BV1089200000	5410439047098	4	12	BA1	Blister A



BZ1798



Waaerveerring DIN 6798A
Rondelle éventail DIN 6798A
Serrated lock washer D6798A
Fächerscheibe DIN 6798A



d [mm]	d _e [mm]	Art. ref.	EAN code			Price code	Packaging
M 4	8	BZ1798040000	5410439354103	35	12	BA1	Blister A
M 5	10	BZ1798050000	5410439354110	25	12	BA1	Blister A
M 6	11	BZ1798060000	5410439354127	20	12	BA1	Blister A
M 8	15	BZ1798080000	5410439354134	20	12	BA1	Blister A
M 10	18	BZ1798100000	5410439354141	19	12	BB1	Blister A
M 12	20,5	BZ1798120000	5410439354158	13	12	BB1	Blister A
M 14	24	BZ1798140000	5410439354165	8	12	BB1	Blister A
M 16	26	BZ1798160000	5410439354172	6	12	BB1	Blister A

BZ0798



Waaerveerring DIN 6798A
Rondelle éventail DIN 6798A
Serrated lock washer D6798A
Fächerscheibe DIN 6798A

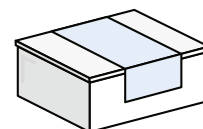

d [mm]	d _e [mm]	Art. ref.	EAN code			Price code	Packaging
M 4	8	BZ0798040000	5410439302159	100	3	BE1	Box 1A
M 5	10	BZ0798050000	5410439302166	120	3	BF1	Box 1A
M 6	11	BZ0798060000	5410439302173	100	3	BF1	Box 1A
M 8	15	BZ0798080000	5410439302180	90	3	BH1	Box 1A
M 10	18	BZ0798100000	5410439302197	60	3	BH1	Box 1A
M 12	20,5	BZ0798120000	5410439302203	45	3	BH1	Box 1A
M 14	24	BZ0798140000	5410439302210	25	3	BH1	Box 1A
M 16	26	BZ0798160000	5410439302227	20	3	BH1	Box 1A

BZ1127



Veerring DIN 127B
Rondelle grower DIN 127B
Single coil spring washer DIN 127B
Federringe DIN 127B



d [mm]	d _e [mm]	Art. ref.	EAN code			Price code	Packaging
M 4	7,6	BZ1127040000	5410439354004	35	12	BA1	Blister A
M 5	9,2	BZ1127050000	5410439354011	30	12	BA1	Blister A
M 6	11,8	BZ1127060000	5410439354028	25	12	BA1	Blister A
M 8	14,8	BZ1127080000	5410439354035	22	12	BA1	Blister A



BZ1127



Veerring DIN 127B
Rondelle grower DIN 127B
Single coil spring washer DIN 127B
Federringe DIN 127B

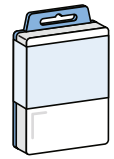

d [mm]	d _e [mm]	Art. ref.	EAN code			Price code	Packaging
M 10	18,1	BZ1127100000	5410439354042	15	12	BA1	Blister A
M 12	21,1	BZ1127120000	5410439354059	10	12	BA1	Blister A
M 14	24,1	BZ1127140000	5410439354066	7	12	BA1	Blister A
M 16	27,4	BZ1127160000	5410439354073	5	12	BA1	Blister A



BZ0127



Veerring DIN 127B
Rondelle grower DIN 127B
Single coil spring washer DIN 127B
Federringe DIN 127B

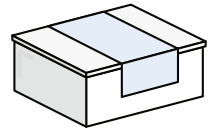

d [mm]	d _e [mm]	Art. ref.	EAN code			Price code	Packaging
M 3	6,2	BZ0127030000	5410439302005	100	3	BC1	Box 1A
M 4	7,6	BZ0127040000	5410439302012	100	3	BD1	Box 1A
M 5	9,2	BZ0127050000	5410439302029	100	3	BD1	Box 1A
M 6	11,8	BZ0127060000	5410439302036	100	3	BE1	Box 1A
M 8	14,8	BZ0127080000	5410439302043	100	3	BG1	Box 1A
M 10	18,1	BZ0127100000	5410439302050	90	3	BH1	Box 1A
M 12	21,1	BZ0127120000	5410439302067	60	3	BH1	Box 1A
M 14	24,1	BZ0127140000	5410439302074	25	3	BH1	Box 1A
M 16	27,4	BZ0127160000	5410439302081	25	3	BH1	Box 1A
M 18	29,4	BZ0127180000	5410439302098	20	3	BH1	Box 1A
M 20	33,6	BZ0127200000	5410439302104	15	3	BG1	Box 1A

BZ10NR



Neopreenring
Rondelle étanche
EPDM Bonded washer
Dichtscheibe EPDM

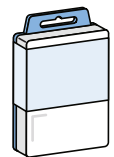

d [mm]	l [mm]	Art. ref.	EAN code			Price code	Packaging
6,8	16	BZ10NR063016	5410439437325	20	12	BB1	Blister A
6,8	19	BZ10NR063019	5410439437332	20	12	BB1	Blister A
6,8	25	BZ10NR063025	5410439437349	20	6	BD1	Blister B





BM1CUV



Cuvette
Cuvette
Cup washer
Hohlscheibe



d [mm]	Art. ref.	EAN code			Price code	Packaging
3	BM1CUV030000	5410439350761	30	12	BC1	Blister A
4	BM1CUV040000	5410439350778	22	12	BC1	Blister A
5	BM1CUV050000	5410439350785	18	12	BC1	Blister A





BN1CUV



Cuvette
Cuvette
Cup washer
Hohlscheibe



d [mm]	Art. ref.	EAN code			Price code	Packaging
3	BN1CUV030000	5410439350709	30	12	BC1	Blister A
4	BN1CUV040000	5410439350716	18	12	BC1	Blister A
5	BN1CUV050000	5410439350723	18	12	BC1	Blister A





BN10SR



Schoenring
Oeillet pour chaussures
Eyelet for shoes
Öse für Schuhe



d [mm]	Art. ref.	EAN code			Price code	Packaging
4	BN10SR040000	5410439198653	30	12	BA1	Blister A
5	BN10SR050000	5410439369015	25	12	BA1	Blister A
6	BN10SR060000	5410439198660	20	12	BA1	Blister A



BM10DK



Drukknop
Bouton-pression
Button
Druckknöpfe



d [mm]	Art. ref.	EAN code			Price code	Packaging
15	BM10DK150000	5410439368049	4	12	BH1	Blister A





BM10ZR

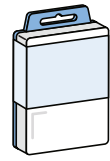

Zeilringen met tegenring
 Oeillet pour baches avec rondelle
 Brass sail eyelets with washer
 Planösen mit flache scheibe



d [mm]	Art. ref.	EAN code			Price code	Packaging
7	BM10ZR070000	5410439174701	12	12	BB1	Blister A
7	BM10ZR07W000	5410439320887	1	6	BV1	Blister B
8	BM10ZR080000	5410439350815	8	12	BB1	Blister A
8	BM10ZR08W000	5410439320863	1	6	BV1	Blister B
10	BM10ZR100000	5410439350822	6	12	BB1	Blister A
10	BM10ZR10W000	5410439320870	1	6	BV1	Blister B

ZELFBORENDE SCHROEVEN
VIS AUTO-FOREUSES
SELF-DRILLING SCREWS
SELBSTBOHRENDE SCHRAUBEN





BZ1981

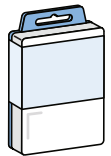

Plaatschroef met cilindrische kop DIN 7981
Vis taraudeuse à tête cylindrique DIN 7981
Tapping screw with cylindrical head DIN 7981
Blechtschraube mit zylindrischem Kopf DIN 7981



d [mm]	l [mm]	Art. ref.	EAN code			Price code	Packaging
2,9	6,5	BZ1981029006	5410439351508	22	12	BA1	Blister A
2,9	9,5	BZ1981029009	5410439351515	18	12	BA1	Blister A
2,9	13	BZ1981029013	5410439351522	18	12	BA1	Blister A
2,9	16	BZ1981029016	5410439351539	17	12	BA1	Blister A
3,5	13	BZ1981035013	5410439351607	15	12	BA1	Blister A
3,5	16	BZ1981035016	5410439351614	14	12	BA1	Blister A
3,5	19	BZ1981035019	5410439351621	13	12	BA1	Blister A
3,5	25	BZ1981035025	5410439351638	12	12	BA1	Blister A
4,2	13	BZ1981042013	5410439351706	11	12	BA1	Blister A
4,2	16	BZ1981042016	5410439351744	11	12	BA1	Blister A
4,2	19	BZ1981042019	5410439351713	10	12	BA1	Blister A
4,2	25	BZ1981042025	5410439351720	9	12	BA1	Blister A
4,2	38	BZ1981042038	5410439351737	7	12	BA1	Blister A
4,8	19	BZ1981048019	5410439351805	9	12	BA1	Blister A
4,8	25	BZ1981048025	5410439351812	7	12	BA1	Blister A
4,8	38	BZ1981048038	5410439351829	7	12	BB1	Blister A
4,8	50	BZ1981048050	5410439351836	6	12	BB1	Blister A
5,5	16	BZ1981055016	5410439351843	11	12	BB1	Blister A
5,5	19	BZ1981055019	5410439351850	11	12	BB1	Blister A
5,5	25	BZ1981055025	5410439351867	10	12	BB1	Blister A
5,5	32	BZ1981055032	5410439351874	9	12	BB1	Blister A
5,5	38	BZ1981055038	5410439351881	7	12	BB1	Blister A
5,5	50	BZ1981055050	5410439351898	7	12	BB1	Blister A





BZ0981

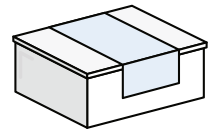

Plaatschroef met cilindrische kop DIN 7981
 Vis taraudeuse à tête cylindrique DIN 7981
 Tapping screw with cylindrical head DIN 7981
 Blechschraube mit zylindrischem Kopf DIN 7981





d [mm]	l [mm]	Art. ref.	EAN code			Price code	Packaging
2,9	6,5	BZ0981029006	5410439300704	100	3	BF1	Box 1A
2,9	9,5	BZ0981029009	5410439300711	100	3	BF1	Box 1A
2,9	13	BZ0981029013	5410439300728	100	3	BF1	Box 1A
2,9	16	BZ0981029016	5410439300735	100	3	BF1	Box 1A
3,5	9,5	BZ0981035009	5410439300759	100	3	BF1	Box 1A
3,5	13	BZ0981035013	5410439300766	100	3	BG1	Box 1A
3,5	16	BZ0981035016	5410439300797	100	3	BH1	Box 1A
3,5	19	BZ0981035019	5410439300773	100	3	BH1	Box 1A
3,5	25	BZ0981035025	5410439300780	100	3	BH3	Box 1A
3,5	32	BZ0981035032	5410439300742	100	3	BI1	Box 1A
3,9	13	BZ0981039013	5410439300803	100	3	BH1	Box 1A
3,9	19	BZ0981039019	5410439300810	100	3	BH3	Box 1A
3,9	25	BZ0981039025	5410439300827	100	3	BI1	Box 1A
3,9	32	BZ0981039032	5410439300834	100	3	BJ1	Box 1A
4,2	16	BZ0981042016	5410439300841	100	3	BH3	Box 1A
4,2	19	BZ0981042019	5410439300865	100	3	BI1	Box 1A
4,2	25	BZ0981042025	5410439013925	100	3	BJ1	Box 1A
4,2	32	BZ0981042032	5410439300872	100	3	BJ1	Box 2A
4,2	38	BZ0981042038	5410439300889	100	3	BJ1	Box 2A
4,8	13	BZ0981048013	5410439013932	100	3	BI1	Box 2A
4,8	19	BZ0981048019	5410439300896	100	3	BL1	Box 2A
4,8	25	BZ0981048025	5410439300902	100	3	BK1	Box 2A
4,8	32	BZ0981048032	5410439300919	90	1	BL1	Box 3A
4,8	38	BZ0981048038	5410439300926	90	1	BN1	Box 3A
4,8	50	BZ0981048050	5410439300933	100	1	BQ1	Box 3A

BZ1983



Plaatschroef met bolle verzonken kop DIN 7983
 Vis taraudeuse à tête fraisée bombée DIN 7983
 Tapping screw round countersunk head DIN 7983
 Blechschraube mit Linsensenkkopf DIN 7983



d [mm]	l [mm]	Art. ref.	EAN code			Price code	Packaging
2,9	9,5	BZ1983029009	5410439351911	17	12	BA1	Blister A
2,9	13	BZ1983029013	5410439351928	16	12	BA1	Blister A
2,9	16	BZ1983029016	5410439351935	15	12	BA1	Blister A
3,9	13	BZ1983039013	5410439352000	13	12	BA1	Blister A
3,9	16	BZ1983039016	5410439352017	12	12	BA1	Blister A



BZ1983



Plaatschroef met bolle verzonken kop DIN 7983
 Vis taraudeuse à tête fraisée bombée DIN 7983
 Tapping screw round countersunk head DIN 7983
 Blechschraube mit Linsensenkopf DIN 7983



d [mm]	l [mm]	Art. ref.	EAN code			Price code	Packaging
3,9	19	BZ1983039019	5410439352024	11	12	BA1	Blister A
3,9	25	BZ1983039025	5410439352031	10	12	BA1	Blister A
4,8	19	BZ1983048019	5410439352109	8	12	BA1	Blister A
4,8	25	BZ1983048025	5410439352116	7	12	BA1	Blister A
4,8	38	BZ1983048038	5410439352123	7	12	BA1	Blister A
4,8	50	BZ1983048050	5410439352130	7	12	BB1	Blister A

BZ0983



Plaatschroef met bolle verzonken kop DIN 7983
 Vis taraudeuse à tête fraisée bombée DIN 7983
 Tapping screw round countersunk head DIN 7983
 Blechschraube mit Linsensenkopf DIN 7983

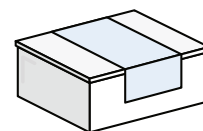

d [mm]	l [mm]	Art. ref.	EAN code			Price code	Packaging
2,9	9,5	BZ0983029009	5410439301008	100	3	BF1	Box 1A
2,9	13	BZ0983029013	5410439301015	100	3	BF1	Box 1A
2,9	16	BZ0983029016	5410439301022	100	3	BG1	Box 1A
3,9	13	BZ0983039013	5410439301053	100	3	BH1	Box 1A
3,9	16	BZ0983039016	5410439010603	100	3	BH3	Box 1A
3,9	19	BZ0983039019	5410439301077	100	3	BH3	Box 1A
3,9	25	BZ0983039025	5410439301084	100	3	BI1	Box 1A
4,8	19	BZ0983048019	5410439301107	100	3	BJ1	Box 1A
4,8	25	BZ0983048025	5410439301114	100	3	BK1	Box 2A
4,8	32	BZ0983048032	5410439301121	100	3	BL1	Box 2A
4,8	38	BZ0983048038	5410439301138	100	3	BM1	Box 2A
4,8	50	BZ0983048050	5410439301145	100	1	BP1	Box 3A

BZ104K



Zelfborende schroef met zeskantkop DIN 7504K
 Vis autoforante à tête hexagonale DIN 7504K
 Selfdrilling screw with hexagonal head DIN 7504K
 Bohrschraube mit Sechskantkopf DIN 7504K



d [mm]	l [mm]	Art. ref.	EAN code			Price code	Packaging
3,5	9,5	BZ104K035009	5410439350853	25	12	BC1	Blister A
3,5	13	BZ104K035013	5410439350860	24	12	BC1	Blister A



BZ104K



Zelfborende schroef met zeskantkop DIN 7504K
 Vis autoforante à tête hexagonale DIN 7504K
 Selfdrilling screw with hexagonal head DIN 7504K
 Bohrschraube mit Sechskantkopf DIN 7504K

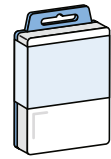

d [mm]	l [mm]	Art. ref.	EAN code			Price code	Packaging
3,5	16	BZ104K035016	5410439350969	22	12	BC1	Blister A
3,5	19	BZ104K035019	5410439350976	20	12	BC1	Blister A
4,2	13	BZ104K042013	5410439350983	22	12	BC1	Blister A
4,2	16	BZ104K042016	5410439350877	20	12	BC1	Blister A
4,2	19	BZ104K042019	5410439350884	19	12	BC1	Blister A
4,2	25	BZ104K042025	5410439350891	17	12	BC1	Blister A
4,8	16	BZ104K048016	5410439350907	15	12	BC1	Blister A
4,8	19	BZ104K048019	5410439350914	14	12	BC1	Blister A
4,8	25	BZ104K048025	5410439350921	13	12	BC1	Blister A
4,8	32	BZ104K048032	5410439350990	12	12	BC1	Blister A
5,5	25	BZ104K055025	5410439350938	10	12	BC1	Blister A
5,5	32	BZ104K055032	5410439350945	9	12	BC1	Blister A
5,5	38	BZ104K055038	5410439350952	8	12	BC1	Blister A

BZ004K



Zelfborende schroef met zeskantkop DIN 7504K
 Vis autoforante à tête hexagonale DIN 7504K
 Selfdrilling screw with hexagonal head DIN 7504K
 Bohrschraube mit Sechskantkopf DIN 7504K

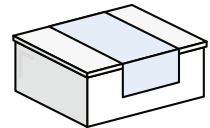

d [mm]	l [mm]	Art. ref.	EAN code			Price code	Packaging
3,5	9,5	BZ004K035009	5410439306003	100	3	BI1	Box 1A
3,5	13	BZ004K035013	5410439306010	100	3	BI1	Box 1A
3,5	16	BZ004K035016	5410439306027	100	3	BI1	Box 1A
3,5	19	BZ004K035019	5410439306034	100	3	BI1	Box 1A
4,2	13	BZ004K042013	5410439306133	100	3	BJ1	Box 1A
4,2	16	BZ004K042016	5410439306041	100	3	BJ1	Box 1A
4,2	19	BZ004K042019	5410439306058	100	3	BK1	Box 1A
4,2	25	BZ004K042025	5410439306065	100	3	BK1	Box 2A
4,8	16	BZ004K048016	5410439306072	100	3	BL1	Box 1A
4,8	19	BZ004K048019	5410439306089	100	3	BM1	Box 2A
4,8	25	BZ004K048025	5410439306096	100	3	BN1	Box 2A
4,8	32	BZ004K048032	5410439306140	100	3	BO1	Box 2A
5,5	25	BZ004K055025	5410439306102	100	3	BQ1	Box 2A
5,5	32	BZ004K055032	5410439306119	100	1	BQ1	Box 3A
5,5	38	BZ004K055038	5410439306126	80	1	BQ1	Box 3A



BZ104N





Zelfborende schroef met cilindrische kop DIN 7504N

Vis autoforante à tête cylindrique DIN 7504N

Selfdrilling screw with cylindrical head DIN 7504N

Bohrschraube mit zylindrischem Kopf DIN 7504N



d [mm]	l [mm]	Art. ref.	EAN code			Price code	Packaging
3,5	9,5	BZ104N035009	5410439356015	25	12	BB1	Blister A
3,5	13	BZ104N035013	5410439356022	25	12	BB1	Blister A
3,5	16	BZ104N035016	5410439356091	22	12	BB1	Blister A
3,5	19	BZ104N035019	5410439356138	20	12	BB1	Blister A
4,2	16	BZ104N042016	5410439356039	20	12	BB1	Blister A
4,2	19	BZ104N042019	5410439356046	19	12	BB1	Blister A
4,2	25	BZ104N042025	5410439356053	17	12	BB1	Blister A
4,2	32	BZ104N042032	5410439356114	14	12	BB1	Blister A
4,8	16	BZ104N048016	5410439356060	14	12	BB1	Blister A
4,8	19	BZ104N048019	5410439356077	13	12	BB1	Blister A
4,8	25	BZ104N048025	5410439356084	12	12	BB1	Blister A
4,8	32	BZ104N048032	5410439356121	10	12	BB1	Blister A

BZ004N





Zelfborende schroef met cilindrische kop DIN 7504N

Vis autoforante à tête cylindrique DIN 7504N

Selfdrilling screw with cylindrical head DIN 7504N

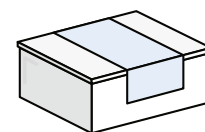
Bohrschraube mit zylindrischem Kopf DIN 7504N



d [mm]	l [mm]	Art. ref.	EAN code			Price code	Packaging
3,5	9,5	BZ004N035009	5410439305006	100	3	BH1	Box 1A
3,5	13	BZ004N035013	5410439305013	100	3	BH3	Box 1A
3,5	16	BZ004N035016	5410439305020	100	3	BH3	Box 1A
3,5	19	BZ004N035019	5410439305037	100	3	BH3	Box 1A
4,2	16	BZ004N042016	5410439305044	100	3	BJ1	Box 1A
4,2	19	BZ004N042019	5410439305051	100	3	BJ1	Box 1A
4,2	25	BZ004N042025	5410439305068	100	3	BK1	Box 1A
4,2	32	BZ004N042032	5410439305075	100	3	BK1	Box 2A
4,8	16	BZ004N048016	5410439305082	100	3	BK1	Box 1A
4,8	19	BZ004N048019	5410439305099	100	3	BK1	Box 1A
4,8	25	BZ004N048025	5410439305105	100	3	BL1	Box 2A
4,8	32	BZ004N048032	5410439305112	100	3	BM1	Box 2A





BZ104P

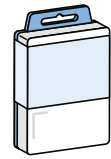

Zelfborende schroef met verzonken kop DIN 7504P
 Vis autoforante à tête fraisée DIN 7504P
 Selfdrilling screw with countersunk head DIN 7504P
 Bohrschraube mit Senkkopf DIN 7504P





d [mm]	l [mm]	Art. ref.	EAN code			Price code	Packaging
3,5	13	BZ104P035013	5410439356206	12	12	BA1	Blister A
3,5	16	BZ104P035016	5410439356213	12	12	BB1	Blister A
3,5	19	BZ104P035019	5410439356220	12	12	BA1	Blister A
3,5	25	BZ104P035025	5410439356237	11	12	BA1	Blister A
4,2	13	BZ104P042013	5410439356251	11	12	BB1	Blister A
4,2	16	BZ104P042016	5410439356268	11	12	BB1	Blister A
4,2	19	BZ104P042019	5410439356275	10	12	BB1	Blister A
4,2	25	BZ104P042025	5410439356282	10	12	BB1	Blister A
4,2	32	BZ104P042032	5410439356299	9	12	BB1	Blister A
4,8	16	BZ104P048016	5410439356305	5	12	BA1	Blister A
4,8	19	BZ104P048019	5410439356312	5	12	BA1	Blister A
4,8	25	BZ104P048025	5410439356329	5	12	BA1	Blister A
4,8	32	BZ104P048032	5410439356336	5	12	BA1	Blister A
4,8	38	BZ104P048038	5410439356343	5	12	BA1	Blister A
4,8	50	BZ104P048050	5410439356367	5	12	BA1	Blister A

BZ004P

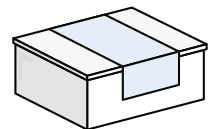

Zelfborende schroef met verzonken kop DIN 7504P
 Vis autoforante à tête fraisée DIN 7504P
 Selfdrilling screw with countersunk head DIN 7504P
 Bohrschraube mit Senkkopf DIN 7504P



d [mm]	l [mm]	Art. ref.	EAN code			Price code	Packaging
3,5	13	BZ004P035013	5410439306201	100	3	BH1	Box 1A
3,5	16	BZ004P035016	5410439306218	100	3	BH3	Box 1A
3,5	19	BZ004P035019	5410439306225	100	3	BH3	Box 1A
3,5	25	BZ004P035025	5410439306232	100	3	BH3	Box 1A
4,2	13	BZ004P042013	5410439306256	100	3	BH3	Box 1A
4,2	16	BZ004P042016	5410439306263	100	3	BI1	Box 1A
4,2	19	BZ004P042019	5410439306270	100	3	BJ1	Box 1A
4,2	25	BZ004P042025	5410439306287	100	3	BJ1	Box 1A
4,2	32	BZ004P042032	5410439306294	100	3	BK1	Box 1A
4,8	16	BZ004P048016	5410439306300	100	3	BJ1	Box 1A
4,8	19	BZ004P048019	5410439306317	100	3	BK1	Box 1A
4,8	25	BZ004P048025	5410439306324	100	3	BL1	Box 2A
4,8	32	BZ004P048032	5410439306331	100	3	BM1	Box 2A
4,8	38	BZ004P048038	5410439306348	100	3	BN1	Box 2A
4,8	45	BZ004P048045	5410439306355	100	1	BO1	Box 3A



BZ004P



Zelfborende schroef met verzonken kop DIN 7504P
 Vis autoforante à tête fraisée DIN 7504P
 Selfdrilling screw with countersunk head DIN 7504P
 Bohrschraube mit Senkkopf DIN 7504P

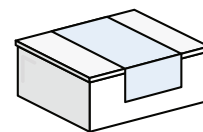

d [mm]	l [mm]	Art. ref.	EAN code			Price code	Packaging
4,8	50	BZ004P048050	5410439306362	100	1	BP1	Box 3A

BZ0G16



Zelfborende schroef met EPDM sluitring
 Vis autoforante avec rondelle en EPDM
 Self drilling screw with EPDM washer
 Bohrschraube mit EPDM Scheibe

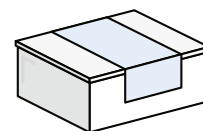

d [mm]	l [mm]	Art. ref.	EAN code			Price code	Packaging
6,3	19	BZ0G16063019	5410439157247	20	3	BE1	Box 1A
6,3	25	BZ0G16063025	5410439157254	20	3	BE1	Box 1A
6,3	32	BZ0G16063032	5410439157278	20	3	BF1	Box 2A
6,3	38	BZ0G16063038	5410439157285	20	3	BG1	Box 2A
6,3	50	BZ0G16063050	5410439157292	20	3	BH1	Box 2A
6,3	63	BZ0G16063063	5410439157322	20	3	BH1	Box 2A
6,3	75	BZ0G16063075	5410439157339	20	3	BI1	Box 2A
6,3	90	BZ0G16063090	5410439157384	20	1	BJ1	Box 4A
6,3	115	BZ0G16063115	5410439157414	20	1	BL1	Box 4A

PENNEN & KLINKNAGELS
GOUPILLES & RIVETS
PINS & RIVETS
STIFTE & NIETEN

BZ1094



Splitpen DIN 94
 Goupille fendue DIN 94
 Split pin DIN 94
 Splinte DIN 94

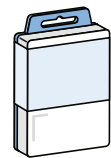

d [mm]	l [mm]	Art. ref.	EAN code			Price code	Packaging
1,6	20	BZ1094016020	5410439350303	25	12	BB1	Blister A
2	25	BZ1094020025	5410439350310	17	12	BB1	Blister A
2,5	32	BZ1094025032	5410439350327	12	12	BB1	Blister A
3,2	40	BZ1094032040	5410439350334	14	12	BC1	Blister A
4	50	BZ1094040050	5410439350341	10	12	BC1	Blister A
5	63	BZ1094050063	5410439350358	6	12	BC1	Blister A

BZ0094



Splitpen DIN 94
 Goupille fendue DIN 94
 Split pin DIN 94
 Splinte DIN 94

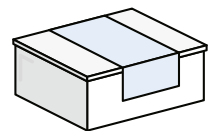

d [mm]	l [mm]	Art. ref.	EAN code			Price code	Packaging
1,6	20	BZ0094016020	5410439300308	80	3	BG1	Box 1A
2	25	BZ0094020025	5410439300315	55	3	BF1	Box 1A
2,5	32	BZ0094025032	5410439300322	50	3	BG1	Box 1A
3,2	40	BZ0094032040	5410439300339	48	3	BH3	Box 1A
4	50	BZ0094040050	5410439300346	50	3	BJ1	Box 1A
5	63	BZ0094050063	5410439300353	25	3	BJ1	Box 1A

BZ1024



Verende borgclip
 Goupille
 Spring pin standard
 Standard-Federstecker doppel

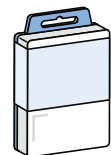

d [mm]	l [mm]	Art. ref.	EAN code			Price code	Packaging
2	50	BZ1024020050	5410439350402	4	12	BC1	Blister A



BZ1024



Verende borgclip
Goupille
Spring pin standard
Standard-Federstecker doppel



d [mm]	l [mm]	Art. ref.	EAN code			Price code	Packaging
3	60	BZ1024030060	5410439350419	3	12	BC1	Blister A
4	80	BZ1024040080	5410439350426	3	3	BD1	Blister E

BM10BR



Buisrivet
Rivet tubulaire
Tubular rivet
Hohlriete



d [mm]	Art. ref.	EAN code			Price code	Packaging
7	BM10BR070000	5410439368001	7	12	BB1	Blister A
9	BM10BR090000	5410439368018	6	12	BB1	Blister A
10	BM10BR100000	5410439368025	4	12	BB1	Blister A
12	BM10BR120000	5410439368032	3	12	BB1	Blister A

BZ137A



Blindklinknagel met bolkop DIN 7337A
Rivet aveugle à tête ronde DIN 7337A
Blind rivet with round head DIN 7337A
Blindriete mit rundem Kopf DIN 7337A





d [mm]	l [mm]	Art. ref.	EAN code			Price code	Packaging
3	6	BZ137A030006	5410439237833	14	12	BC1	Blister A
3	8	BZ137A030008	5410439237840	14	12	BC1	Blister A
3	10	BZ137A030010	5410439237857	14	12	BC1	Blister A
3	12	BZ137A030012	5410439237864	14	12	BC1	Blister A
3,2	6	BZ137A032006	5410439350006	14	12	BC1	Blister A
3,2	8	BZ137A032008	5410439350013	14	12	BC1	Blister A
3,2	10	BZ137A032010	5410439350020	14	12	BC1	Blister A
3,2	12	BZ137A032012	5410439350037	14	12	BC1	Blister A
3,2	14	BZ137A032014	5410439237871	14	12	BC1	Blister A
4	6	BZ137A040006	5410439350105	14	12	BC1	Blister A
4	8	BZ137A040008	5410439350112	14	12	BC1	Blister A
4	10	BZ137A040010	5410439350129	14	12	BC1	Blister A
4	12	BZ137A040012	5410439350136	14	12	BC1	Blister A
4	14	BZ137A040014	5410439237888	14	12	BC1	Blister A

BZ137A

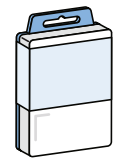

Blindklinknagel met bolkop DIN 7337A
Rivet aveugle à tête ronde DIN 7337A
Blind rivet with round head DIN 7337A
Blindniete mit rundem Kopf DIN 7337A





d [mm]	l [mm]	Art. ref.	EAN code			Price code	Packaging
4	16	BZ137A040016	5410439237895	14	12	BC1	Blister A
4	18	BZ137A040018	5410439239684	14	12	BC1	Blister A
4	20	BZ137A040020	5410439237901	12	12	BC1	Blister A
4	25	BZ137A040025	5410439237918	10	12	BC1	Blister A
4,8	6	BZ137A048006	5410439237925	14	12	BC1	Blister A
4,8	8	BZ137A048008	5410439350204	13	12	BC1	Blister A
4,8	10	BZ137A048010	5410439350211	13	12	BC1	Blister A
4,8	12	BZ137A048012	5410439350228	12	12	BC1	Blister A
4,8	14	BZ137A048014	5410439350235	11	12	BC1	Blister A
4,8	16	BZ137A048016	5410439237932	10	12	BC1	Blister A
4,8	18	BZ137A048018	5410439237949	10	12	BC1	Blister A
4,8	20	BZ137A048020	5410439237956	10	12	BC1	Blister A
4,8	22	BZ137A048022	5410439237963	10	12	BC1	Blister A
4,8	25	BZ137A048025	5410439237970	8	12	BC1	Blister A
4,8	28	BZ137A048028	5410439237987	8	12	BC1	Blister A
4,8	30	BZ137A048030	5410439237994	7	12	BC1	Blister A
6	10	BZ137A060010	5410439238007	8	12	BC1	Blister A
6	12	BZ137A060012	5410439238014	8	12	BE1	Blister A
6	14	BZ137A060014	5410439238021	8	12	BE1	Blister A
6	16	BZ137A060016	5410439238038	8	12	BE1	Blister A
6	18	BZ137A060018	5410439238045	8	6	BE1	Blister B
6	22	BZ137A060022	5410439238052	8	6	BE1	Blister B
6	26	BZ137A060026	5410439239677	8	6	BE1	Blister B
6	30	BZ137A060030	5410439238069	8	6	BE1	Blister B

BZ037A

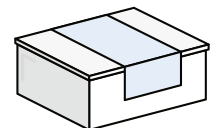

Blindklinknagel met bolkop DIN 7337A
Rivet aveugle à tête ronde DIN 7337A
Blind rivet with round head DIN 7337A
Blindniete mit rundem Kopf DIN 7337A





d [mm]	l [mm]	Art. ref.	EAN code			Price code	Packaging
3	6	BZ037A030006	5410439236942	100	3	BG1	Box 1A
3	8	BZ037A030008	5410439236959	100	3	BG1	Box 1A
3	10	BZ037A030010	5410439236966	100	3	BH1	Box 1A
3	12	BZ037A030012	5410439236973	100	3	BH1	Box 1A
3,2	6	BZ037A032006	5410439300018	100	3	BG1	Box 1A
3,2	8	BZ037A032008	5410439300025	100	3	BH1	Box 1A

BZ037A

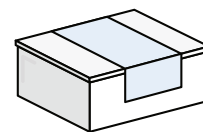

Blindklinknagel met bolkop DIN 7337A
Rivet aveugle à tête ronde DIN 7337A
Blind rivet with round head DIN 7337A
Blindniete mit rundem Kopf DIN 7337A





d [mm]	l [mm]	Art. ref.	EAN code			Price code	Packaging
3,2	10	BZ037A032010	5410439300032	100	3	BH1	Box 1A
3,2	12	BZ037A032012	5410439300049	100	3	BH1	Box 1A
3,2	14	BZ037A032014	5410439236935	100	3	BH1	Box 2A
4	6	BZ037A040006	5410439300063	100	3	BH3	Box 2A
4	8	BZ037A040008	5410439300070	100	3	BH3	Box 2A
4	10	BZ037A040010	5410439300087	100	3	BH3	Box 2A
4	12	BZ037A040012	5410439300094	100	3	BH3	Box 2A
4	14	BZ037A040014	5410439300100	100	3	BI1	Box 2A
4	16	BZ037A040016	5410439237000	100	3	BI1	Box 2A
4	18	BZ037A040018	5410439300117	100	3	BI1	Box 2A
4	20	BZ037A040020	5410439237017	100	3	BJ1	Box 2A
4	25	BZ037A040025	5410439237024	100	1	BK1	Box 3A
4,8	6	BZ037A048006	5410439237031	100	3	BI1	Box 2A
4,8	8	BZ037A048008	5410439300131	100	3	BI1	Box 2A
4,8	10	BZ037A048010	5410439300148	100	3	BJ1	Box 2A
4,8	12	BZ037A048012	5410439300155	100	3	BJ1	Box 2A
4,8	14	BZ037A048014	5410439300162	100	3	BJ1	Box 2A
4,8	16	BZ037A048016	5410439300179	100	1	BK1	Box 3A
4,8	18	BZ037A048018	5410439237048	100	1	BK1	Box 3A
4,8	20	BZ037A048020	5410439300186	100	1	BK1	Box 3A
4,8	22	BZ037A048022	5410439300193	100	1	BL1	Box 3A
4,8	25	BZ037A048025	5410439300209	100	1	BL1	Box 3A
4,8	28	BZ037A048028	5410439237055	100	1	BL1	Box 3A
4,8	30	BZ037A048030	5410439237062	100	1	BM1	Box 3A
6	12	BZ037A060012	5410439237123	100	1	BN1	Box 4A
6	16	BZ037A060016	5410439237116	100	1	BO1	Box 4A
6	18	BZ037A060018	5410439237109	100	1	BO1	Box 4A
6	22	BZ037A060022	5410439237093	100	1	BP1	Box 5A
6	26	BZ037A060026	5410439237086	100	1	BP1	Box 5A
6	30	BZ037A060030	5410439237079	100	1	BQ1	Box 4A

BZ137C

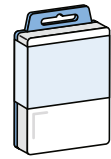

Blindlinknagel met grote kop DIN 7337C
Rivet aveugle à tête large DIN 7337C
Blind rivet with large head DIN 7337C
Blindniete mit großem Kopf DIN 7337C





d [mm]	l [mm]	Art. ref.	EAN code			Price code	Packaging
4	12	BZ137C040012	5410439238335	10	12	BE1	Blister A
4	16	BZ137C040016	5410439238342	10	12	BE1	Blister A
4	20	BZ137C040020	5410439238359	10	12	BE1	Blister A
4,8	12	BZ137C048012	5410439238366	10	6	BE1	Blister B
4,8	14	BZ137C048014	5410439238373	10	6	BE1	Blister B
4,8	16	BZ137C048016	5410439238380	10	6	BE1	Blister B
4,8	18	BZ137C048018	5410439238397	10	6	BF1	Blister B
4,8	20	BZ137C048020	5410439238403	10	6	BF1	Blister B
4,8	24	BZ137C048024	5410439238410	10	6	BF1	Blister B
4,8	26	BZ137C048026	5410439238427	10	6	BG1	Blister B

BZ037C

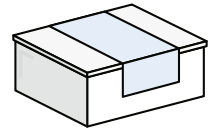

Blindlinknagel met grote kop DIN 7337C
Rivet aveugle à tête large DIN 7337C
Blind rivet with large head DIN 7337C
Blindniete mit großem Kopf DIN 7337C



d [mm]	l [mm]	Art. ref.	EAN code			Price code	Packaging
4	12	BZ037C040012	5410439237147	100	1	BL1	Box 4A
4	16	BZ037C040016	5410439237154	100	1	BM1	Box 4A
4	20	BZ037C040020	5410439237161	100	1	BO1	Box 4A
4,8	12	BZ037C048012	5410439312004	100	1	BO1	Box 4A
4,8	14	BZ037C048014	5410439312011	100	1	BO1	Box 4A
4,8	16	BZ037C048016	5410439237130	100	1	BP1	Box 4A
4,8	18	BZ037C048018	5410439312028	100	1	BQ1	Box 5A
4,8	20	BZ037C048020	5410439312035	100	1	BQ1	Box 5A
4,8	24	BZ037C048024	5410439312042	100	1	BS1	Box 5A
4,8	26	BZ037C048026	5410439312059	100	1	BV1	Box 5A





**ROESTVAST STALEN BEVESTIGINGEN
FIXATIONS EN ACIER INOXYDABLE
STAINLESS STEEL FASTENERS
BEFESTIGUNGEN AUS EDELSTAHL**

BOLTS

SA1933			142
SA0933			143
SA1931			144
SB1933			144
SB0933			145
SB1931			146

NUTS

SA1934			147
SA0934			147
SB1934			148
SA1985			148
SA0985			148
SB1985			149
SA1315			149
SA0315			150
SB1315			150
SA1587			150
SA0587			151
SB1587			151

WASHERS

SA1125			152
SA0125			152
SB1125			153
SA1021			153
SA0021			153
SB1021			154
SA1127			154
SA0127			155
SB1127			155
SA10NR			156

SOCKET SCREWS

SB1912			157
SB1991			157

MACHINE SCREWS

SA1084			159
SA0084			160
SA1963			160
SA0965			161

SCREWS WITH VARIOUS HEAD FORMS

SB1582			163
SB1580			163





SELFDRILLING/TAPPING SCREWS

SA1981			164
SA0981			164
SA104K			165







WOOD SCREWS

SA1571			166
SA0571			166
SA1603			167
SA0603			167
SA195R			168
SA095R			168
SA10WP			168
SA00WP			169
SA1TWP			171
SB1TRS			171
SA1TZB			172
SA1TTG			172
SA10SO			173
SA1MSO			173
SA10SD			173
SA10SH			173
SA1MSH			174
NAILS			
SA1NPK			175
SA0NPK			175
SA1NRK			176
SA0NRK			176

PINS

SB1024			177
SB1094			177

BLIND RIVET

SR137A			178
SA137A			178
SA037A			179

BOUTEN
BOLTS
BOULONS
SCHRAUBEN



SA1933



Zeskantbout met moer DIN 933/934
Vis à tête hexagonal avec écrou DIN 933/934
Hexagonal screw with nut DIN 933/934
Sechskantschraube mit Mutter DIN 933/934

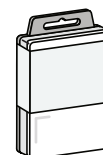

d [mm]	l [mm]	Art. ref.	EAN code			Price code	Packaging
M 5	10	SA1933050010	5410439396011	10	12	SD1	Blister A
M 5	16	SA1933050016	5410439396028	10	12	SD1	Blister A
M 5	20	SA1933050020	5410439396035	8	12	SD1	Blister A
M 5	25	SA1933050025	5410439396042	8	12	SD1	Blister A
M 5	30	SA1933050030	5410439396059	6	12	SD1	Blister A
M 5	40	SA1933050040	5410439396066	4	12	SD1	Blister A
M 6	16	SA1933060016	5410439396110	8	12	SH3	Blister A
M 6	20	SA1933060020	5410439396127	6	12	SH1	Blister A
M 6	25	SA1933060025	5410439396134	6	12	SD1	Blister A
M 6	30	SA1933060030	5410439396141	4	12	SD1	Blister A
M 6	40	SA1933060040	5410439396158	4	12	SD1	Blister A
M 8	20	SA1933080020	5410439396219	4	6	SI1	Blister B
M 8	25	SA1933080025	5410439396226	4	6	SI1	Blister B
M 8	30	SA1933080030	5410439396233	4	6	SJ1	Blister B
M 8	40	SA1933080040	5410439396240	4	6	SJ1	Blister B
M 8	50	SA1933080050	5410439396257	4	6	SK1	Blister B
M 8	60	SA1933080060	5410439396264	4	6	SL1	Blister B
M 10	20	SA1933100020	5410439123075	2	6	SF1	Blister B
M 10	30	SA1933100030	5410439123082	2	6	SF1	Blister B
M 10	40	SA1933100040	5410439123099	2	6	SG1	Blister B
M 10	50	SA1933100050	5410439123105	2	6	SI1	Blister B
M 10	60	SA1933100060	5410439123112	2	6	SI1	Blister B
M 10	80	SA1933100080	5410439123129	2	3	SK1	Blister E
M 12	30	SA1933120030	5410439123136	2	6	SI1	Blister B
M 12	40	SA1933120040	5410439123143	2	6	SJ1	Blister B
M 12	50	SA1933120050	5410439123150	2	6	SJ1	Blister B
M 12	60	SA1933120060	5410439123167	2	3	SK1	Blister E
M 12	80	SA1933120080	5410439123174	2	3	SM1	Blister E
M 12	100	SA1933120100	5410439123181	2	3	SN1	Blister E
M 14	30	SA1933140030	5410439277235	2	6	SJ1	Blister B
M 14	40	SA1933140040	5410439277242	2	6	SJ1	Blister B
M 14	50	SA1933140050	5410439277259	2	6	SK1	Blister B
M 14	60	SA1933140060	5410439277266	2	6	SK1	Blister B



SA1933



Zeskantbout met moer DIN 933/934
 Vis à tête hexagonal avec écrou DIN 933/934
 Hexagonal screw with nut DIN 933/934
 Sechskantschraube mit Mutter DIN 933/934

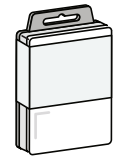

d [mm]	l [mm]	Art. ref.	EAN code			Price code	Packaging
M 16	40	SA1933160040	5410439277273	2	6	SL1	Blister B
M 16	50	SA1933160050	5410439277280	2	6	SL1	Blister B
M 16	60	SA1933160060	5410439277297	2	6	SM1	Blister B
M 16	80	SA1933160080	5410439277303	2	1	SO1	Blister 2

SA0933



Zeskantbout met moer DIN 933/934
 Vis à tête hexagonal avec écrou DIN 933/934
 Hexagonal screw with nut DIN 933/934
 Sechskantschraube mit Mutter DIN 933/934

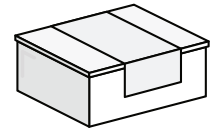

d [mm]	l [mm]	Art. ref.	EAN code			Price code	Packaging
M 5	10	SA0933050010	5410439346016	50	3	SL1	Box 1A
M 5	16	SA0933050016	5410439346023	50	3	SM1	Box 1A
M 5	20	SA0933050020	5410439346030	50	3	SM1	Box 1A
M 5	25	SA0933050025	5410439346047	50	3	SM1	Box 1A
M 5	30	SA0933050030	5410439346054	50	3	SN1	Box 1A
M 6	16	SA0933060016	5410439346115	50	3	SP1	Box 1A
M 6	20	SA0933060020	5410439346122	50	3	SQ1	Box 2A
M 6	25	SA0933060025	5410439346139	50	3	SR1	Box 2A
M 6	30	SA0933060030	5410439346146	50	3	SS1	Box 2A
M 6	40	SA0933060040	5410439346153	50	3	SV1	Box 2A
M 8	20	SA0933080020	5410439346214	25	3	SQ1	Box 2A
M 8	25	SA0933080025	5410439346221	25	3	SR1	Box 2A
M 8	30	SA0933080030	5410439346238	25	3	SS1	Box 2A
M 8	40	SA0933080040	5410439346245	25	3	SV1	Box 2A
M 8	50	SA0933080050	5410439346252	20	3	SV1	Box 2A
M 8	60	SA0933080060	5410439346269	20	3	SV1	Box 2A



SA1931



Zeskantbout met moer DIN 931/934
 Vis à tête hexagonal avec écrou DIN 931/934
 Hexagonal screw with nut DIN 931/934
 Sechskantschraube mit Mutter DIN 931/934

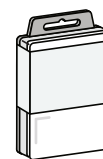

d [mm]	l [mm]	Art. ref.	EAN code			Price code	Packaging
M14	70	SA1931140070	5410439278171	2	3	SN1	Blister E
M14	80	SA1931140080	5410439277310	2	3	SO1	Blister E
M14	90	SA1931140090	5410439277327	2	3	SP1	Blister E
M14	100	SA1931140100	5410439277334	2	3	SQ1	Blister E
M14	120	SA1931140120	5410439277341	2	1	SR1	Blister G
M16	100	SA1931160100	5410439277358	2	1	SR1	Blister 2
M16	120	SA1931160120	5410439277365	2	1	SS1	Blister H

SB1933



Zeskantbout met moer DIN 933/934
 Vis à tête hexagonal avec écrou DIN 933/934
 Hexagonal screw with nut DIN 933/934
 Sechskantschraube mit Mutter DIN 933/934



d [mm]	l [mm]	Art. ref.	EAN code			Price code	Packaging
M 5	10	SB1933050010	5410439053013	10	12	SD1	Blister A
M 5	16	SB1933050016	5410439053044	10	12	SD1	Blister A
M 5	20	SB1933050020	5410439052887	8	12	SD1	Blister A
M 5	25	SB1933050025	5410439052931	8	12	SD1	Blister A
M 5	30	SB1933050030	5410439052832	6	12	SD1	Blister A
M 5	40	SB1933050040	5410439052696	4	12	SD1	Blister A
M 6	16	SB1933060016	5410439052986	8	12	SH3	Blister A
M 6	20	SB1933060020	5410439052856	6	12	SH1	Blister A
M 6	25	SB1933060025	5410439052870	6	12	SG1	Blister A
M 6	30	SB1933060030	5410439052719	4	12	SF1	Blister A
M 6	40	SB1933060040	5410439052764	4	12	SF1	Blister A
M 6	50	SB1933060050	5410439052795	4	12	SF1	Blister A
M 6	60	SB1933060060	5410439052818	4	12	SH1	Blister A
M 8	16	SB1933080016	5410439053594	4	6	SG1	Blister B
M 8	20	SB1933080020	5410439053624	4	6	SI1	Blister B
M 8	25	SB1933080025	5410439053679	4	6	SI1	Blister B
M 8	30	SB1933080030	5410439053693	4	6	SJ1	Blister B
M 8	40	SB1933080040	5410439053716	4	6	SJ1	Blister B
M 8	50	SB1933080050	5410439053747	4	6	SK1	Blister B
M 8	60	SB1933080060	5410439053778	4	6	SL1	Blister B
M 10	20	SB1933100020	5410439053808	4	6	SG1	Blister B
M 10	30	SB1933100030	5410439053839	4	6	SH1	Blister B
M 10	40	SB1933100040	5410439053860	4	6	SI1	Blister B



SB1933



Zeskantbout met moer DIN 933/934
 Vis à tête hexagonal avec écrou DIN 933/934
 Hexagonal screw with nut DIN 933/934
 Sechskantschraube mit Mutter DIN 933/934

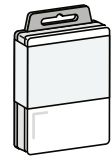

d [mm]	l [mm]	Art. ref.	EAN code			Price code	Packaging
M 10	50	SB1933100050	5410439053891	4	6	SI1	Blister B
M 10	60	SB1933100060	5410439053518	2	6	SI1	Blister B
M 10	80	SB1933100080	5410439054942	2	3	SK1	Blister E
M 12	30	SB1933120030	5410439053921	4	6	SJ1	Blister B
M 12	40	SB1933120040	5410439053952	4	6	SK1	Blister B
M 12	50	SB1933120050	5410439053532	2	6	SJ1	Blister B
M 12	60	SB1933120060	5410439053563	2	6	SK1	Blister B
M 12	80	SB1933120080	5410439055116	2	1	SM1	Blister 2
M 16	30	SB1933160030	5410439062848	2	1	SL1	Blister 2
M 16	40	SB1933160040	5410439055253	2	1	SL1	Blister 2

SB0933



Zeskantbout met moer DIN 933/934
 Vis à tête hexagonal avec écrou DIN 933/934
 Hexagonal screw with nut DIN 933/934
 Sechskantschraube mit Mutter DIN 933/934

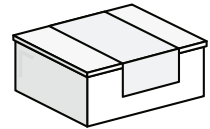



d [mm]	l [mm]	Art. ref.	EAN code			Price code	Packaging
M 10	20	SB0933100020	5410439153645	10	3	SM1	Box 2A
M 10	30	SB0933100030	5410439153652	10	3	SN1	Box 2A
M 10	40	SB0933100040	5410439153669	10	3	SR1	Box 2A
M 10	50	SB0933100050	5410439153676	10	3	SS1	Box 2A
M 10	60	SB0933100060	5410439153683	10	3	ST1	Box 2A
M 10	80	SB0933100080	5410439153690	10	3	SV1	Box 2A
M 12	30	SB0933120030	5410439153706	10	3	SV1	Box 2A
M 12	40	SB0933120040	5410439153720	10	3	SW1	Box 2A
M 12	60	SB0933120060	5410439153737	10	3	SY1	Box 2A
M 12	80	SB0933120080	5410439153751	10	3	SY1	Box 2A

SB1931



Zeskantbout met moer DIN 931/934
 Vis à tête hexagonal avec écrou DIN 931/934
 Hexagonal screw with nut DIN 931/934
 Sechskantschraube mit Mutter DIN 931/934



d [mm]	l [mm]	Art. ref.	EAN code			Price code	Packaging
M 6	80	SB1931060080	5410439055031	4	3	SH1	Blister E
M 8	70	SB1931080070	5410439055062	4	3	SL1	Blister E
M 8	80	SB1931080080	5410439055093	4	3	SM1	Blister E
M 10	100	SB1931100100	5410439054973	2	3	SK1	Blister E
M 10	120	SB1931100120	5410439055000	2	3	SL1	Blister E
M 12	100	SB1931120100	5410439055154	2	1	SM1	Blister 2
M 12	120	SB1931120120	5410439055208	2	1	SN1	Blister 2
M 12	140	SB1931120140	5410439055109	2	1	SP1	Blister G

MOEREN
NUTS
ÉCROUS
MUTTERN

SA1934



Zeskantmoer DIN 934
Ecrou hexagonal DIN 934
Hexagon nut DIN 934
Sechskantmutter DIN 934

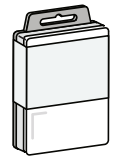

d [mm]	Art. ref.	EAN code			Price code	Packaging
M 3	SA1934030000	5410439397018	10	12	SB1	Blister A
M 4	SA1934040000	5410439397025	10	12	SB1	Blister A
M 5	SA1934050000	5410439397032	10	12	SB1	Blister A
M 6	SA1934060000	5410439397049	8	12	SB1	Blister A
M 8	SA1934080000	5410439397056	6	12	SB1	Blister A
M 10	SA1934100000	5410439397063	4	12	SC1	Blister A
M 12	SA1934120000	5410439123198	5	12	SE1	Blister A
M 14	SA1934140000	5410439367349	4	6	SF1	Blister B
M 16	SA1934160000	5410439123204	4	6	SH1	Blister B

SA0934



Zeskantmoer DIN 934
Ecrou hexagonal DIN 934
Hexagon nut DIN 934
Sechskantmutter DIN 934

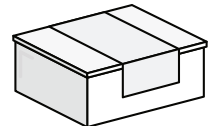

d [mm]	Art. ref.	EAN code			Price code	Packaging
M 3	SA0934030000	5410439347013	100	3	SH3	Box 1A
M 4	SA0934040000	5410439347020	100	3	SH1	Box 1A
M 5	SA0934050000	5410439347037	100	3	SH1	Box 1A
M 6	SA0934060000	5410439347044	100	3	SK1	Box 1A
M 8	SA0934080000	5410439347051	50	3	SK1	Box 1A
M 10	SA0934100000	5410439347068	25	3	SL1	Box 1A
M 12	SA0934120000	5410439701433	15	3	SL1	Box 1A





SB1934

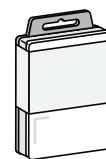

Zeskantmoer DIN 934
Ecrou hexagonal DIN 934
Hexagon nut DIN 934
Sechskantmutter DIN 934





d [mm]	Art. ref.	EAN code			Price code	Packaging
M 4	SB1934040000	5410439047999	8	12	SC1	Blister A
M 5	SB1934050000	5410439048026	8	12	SC1	Blister A
M 6	SB1934060000	5410439048057	8	12	SC1	Blister A
M 8	SB1934080000	5410439048132	8	12	SC1	Blister A
M 10	SB1934100000	5410439048224	4	12	SD1	Blister A
M 12	SB1934120000	5410439048255	4	12	SE1	Blister A
M 14	SB1934140000	5410439050449	4	6	SF1	Blister B
M 16	SB1934160000	5410439050074	2	6	SH1	Blister B
M 18	SB1934180000	5410439050098	2	6	SI1	Blister B
M 20	SB1934200000	5410439050111	2	6	SI1	Blister B

SA1985

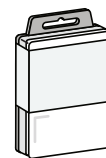

Borgmoer DIN 985
Ecrou de sécurité DIN 985
Hexagonal selflocking nut DIN 985
Sechskantmutter DIN 985





d [mm]	Art. ref.	EAN code			Price code	Packaging
M 6	SA1985060000	5410439202817	4	12	SB1	Blister A
M 8	SA1985080000	5410439202879	4	12	SC1	Blister A
M 10	SA1985100000	5410439202886	4	12	SF1	Blister A
M 12	SA1985120000	5410439202893	2	12	SE1	Blister A
M 14	SA1985140000	5410439277198	2	6	SE1	Blister B
M 16	SA1985160000	5410439277204	2	6	SF1	Blister B

SA0985

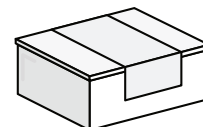

Borgmoer DIN 985
Ecrou de sécurité DIN 985
Hexagonal selflocking nut DIN 985
Sechskantmutter DIN 985



d [mm]	Art. ref.	EAN code			Price code	Packaging
M 5	SA0985050000	5410439349970	50	3	SF1	Box 1A
M 6	SA0985060000	5410439349932	50	3	SG1	Box 1A
M 8	SA0985080000	5410439349949	25	3	SH3	Box 1A
M 10	SA0985100000	5410439349956	25	3	SK1	Box 1A

SA0985

A2
Inox

Borgmoer DIN 985
Ecrou de sécurité DIN 985
Hexagonal selflocking nut DIN 985
Sechskantmutter DIN 985

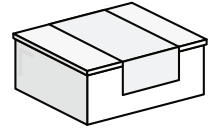



d [mm]	Art. ref.	EAN code			Price code	Packaging
M 12	SA0985120000	5410439349987	15	3	SK1	Box 1A

SB1985

A4
Inox

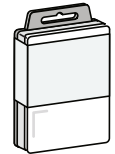
Borgmoer DIN 985
Ecrou de sécurité DIN 985
Hexagonal selflocking nut DIN 985
Sechskantmutter DIN 985





d [mm]	Art. ref.	EAN code			Price code	Packaging
M 4	SB1985040000	5410439048576	8	12	SA1	Blister A
M 5	SB1985050000	5410439049733	8	12	SA1	Blister A
M 6	SB1985060000	5410439049764	8	12	SC1	Blister A
M 8	SB1985080000	5410439049788	8	12	SD1	Blister A
M 10	SB1985100000	5410439048392	4	12	SF1	Blister A
M 12	SB1985120000	5410439048415	4	12	SF1	Blister A
M 14	SB1985140000	5410439050326	2	6	SF1	Blister B
M 16	SB1985160000	5410439050357	2	6	SF1	Blister B
M 18	SB1985180000	5410439050395	2	6	SI1	Blister B
M 20	SB1985200000	5410439050418	2	6	SJ1	Blister B

SA1315

A2
Inox

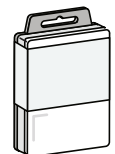
Vleugelmoer Amerikaanse vorm DIN 315AF
Écrou à ailettes modèle américain DIN 315AF
Wing nut American form DIN 315AF
Flügelmutter amerikanische Form DIN 315AF



d [mm]	Art. ref.	EAN code			Price code	Packaging
M 4	SA1315040000	5410439397803	4	12	SE1	Blister A
M 5	SA1315050000	5410439397810	3	12	SE1	Blister A
M 6	SA1315060000	5410439397827	2	12	SE1	Blister A
M 8	SA1315080000	5410439397834	2	6	SE1	Blister B
M 10	SA1315100000	5410439397841	1	6	SE1	Blister B



SA0315



Vleugelmoer Amerikaanse vorm DIN 315AF
 Écrou à ailettes modèle américain DIN 315AF
 Wing nut American form DIN 315AF
 Flügelmutter amerikanische Form DIN 315AF

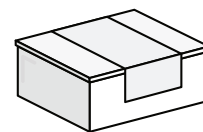

d [mm]	Art. ref.	EAN code			Price code	Packaging
M 4	SA0315040000	5410439347808	25	3	SR1	Box 1A
M 5	SA0315050000	5410439347815	20	3	SP1	Box 1A
M 6	SA0315060000	5410439347822	15	3	SO1	Box 1A
M 8	SA0315080000	5410439347839	10	3	SO1	Box 1A
M 10	SA0315100000	5410439347846	5	3	SM1	Box 1A

SB1315



Vleugelmoer Amerikaanse vorm DIN 315AF
 Écrou à ailettes modèle américain DIN 315AF
 Wing nut American form DIN 315AF
 Flügelmutter amerikanische Form DIN 315AF

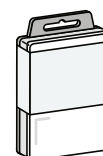

d [mm]	Art. ref.	EAN code			Price code	Packaging
M 4	SB1315040000	5410439048262	4	12	SE1	Blister A
M 5	SB1315050000	5410439048279	4	12	SE1	Blister A
M 6	SB1315060000	5410439048163	2	12	SE1	Blister A
M 8	SB1315080000	5410439050166	2	6	SE1	Blister B
M 10	SB1315100000	5410439050203	2	6	SF1	Blister B
M 12	SB1315120000	5410439050227	2	6	SF1	Blister B

SA1587



Dopmoer DIN 1587
 Ecrou borgne DIN 1587
 Acorn nut DIN 1587
 Sechskant-Hutmutter DIN 1587



d [mm]	Art. ref.	EAN code			Price code	Packaging
M 4	SA1587040000	5410439397902	4	12	SH1	Blister A
M 5	SA1587050000	5410439397919	4	12	SH1	Blister A
M 6	SA1587060000	5410439397926	4	12	SH1	Blister A
M 8	SA1587080000	5410439397933	2	6	SH1	Blister B
M 10	SA1587100000	5410439397940	1	6	SH1	Blister B
M 12	SA1587120000	5410439701754	1	6	SH1	Blister B



SA0587



Dopmoer DIN 1587
 Ecrou borgne DIN 1587
 Acorn nut DIN 1587
 Sechskant-Hutmutter DIN 1587

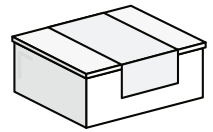

d [mm]	Art. ref.	EAN code			Price code	Packaging
M 4	SA0587040000	5410439347907	25	3	SN1	Box 1A
M 5	SA0587050000	5410439347914	20	3	SK1	Box 1A
M 6	SA0587060000	5410439347921	15	3	SJ1	Box 1A
M 8	SA0587080000	5410439347938	10	3	SK1	Box 1A
M 10	SA0587100000	5410439347945	5	3	SK1	Box 1A

SB1587



Zeskant dopmoer DIN 1587
 Ecrou borgne hexagonal DIN 1587
 Hexagonal domed cap nut DIN 1587
 Sechskant-Hutmutter DIN 1587

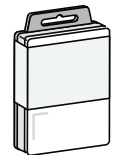

d [mm]	Art. ref.	EAN code			Price code	Packaging
M 4	SB1587040000	5410439048309	4	12	SH1	Blister A
M 5	SB1587050000	5410439048330	4	12	SH1	Blister A
M 6	SB1587060000	5410439048361	4	12	SH1	Blister A
M 8	SB1587080000	5410439050258	2	6	SH1	Blister B
M 10	SB1587100000	5410439050272	2	6	SH1	Blister B
M 12	SB1587120000	5410439050302	2	6	SH1	Blister B

SLUITRINGEN
RONDELLES
WASHERS
SCHEIBEN



SA1125



Sluitring DIN 125A
Rondelle DIN 125A
Washer DIN 125A
Scheibe DIN 125A

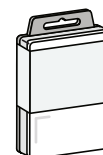

d [mm]	d _e [mm]	Art. ref.	EAN code			Price code	Packaging
M 3	7	SA1125030000	5410439397117	30	12	SB1	Blister A
M 4	8	SA1125040000	5410439397124	25	12	SB1	Blister A
M 5	10	SA1125050000	5410439397131	20	12	SB1	Blister A
M 6	12	SA1125060000	5410439397148	16	12	SB1	Blister A
M 8	16	SA1125080000	5410439397155	10	12	SB1	Blister A
M 10	20	SA1125100000	5410439397162	6	12	SB1	Blister A
M 12	24	SA1125120000	5410439123235	8	12	SC1	Blister A
M 14	28	SA1125140000	5410439367332	5	12	SC1	Blister A
M 16	30	SA1125160000	5410439123242	8	12	SE1	Blister A



SA0125



Sluitring DIN 125A
Rondelle DIN 125A
Washer DIN 125A
Scheibe DIN 125A

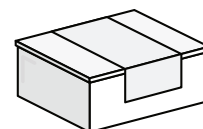

d [mm]	d _e [mm]	Art. ref.	EAN code			Price code	Packaging
M 3	7	SA0125030000	5410439347112	100	3	SD1	Box 1A
M 4	8	SA0125040000	5410439347129	100	3	SE1	Box 1A
M 5	10	SA0125050000	5410439347136	100	3	SF1	Box 1A
M 6	12	SA0125060000	5410439347143	100	3	SJ1	Box 1A
M 8	16	SA0125080000	5410439347150	50	3	SH3	Box 1A
M 10	20	SA0125100000	5410439347167	25	3	SH3	Box 1A
M 12	24	SA0125120000	5410439173780	20	3	SH3	Box 1A
M 16	30	SA0125160000	5410439173797	10	3	SH1	Box 1A



SB1125



Sluiring DIN 125A
Rondelle DIN 125A
Washer DIN 125A
Scheibe DIN 125A

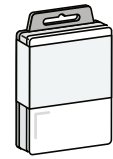

d [mm]	d _e [mm]	Art. ref.	EAN code			Price code	Packaging
M 4	9	SB1125040000	5410439046930	20	12	SB1	Blister A
M 5	10	SB1125050000	5410439046947	20	12	SB1	Blister A
M 6	12	SB1125060000	5410439046954	16	12	SB1	Blister A
M 8	16	SB1125080000	5410439046961	12	12	SB1	Blister A
M 10	20	SB1125100000	5410439047227	8	12	SB1	Blister A
M 12	24	SB1125120000	5410439047234	8	12	SC1	Blister A
M 14	28	SB1125140000	5410439047241	4	12	SC1	Blister A
M 16	30	SB1125160000	5410439047258	4	12	SE1	Blister A
M 18	34	SB1125180000	5410439047265	4	12	SI1	Blister A
M 20	37	SB1125200000	5410439047272	4	12	SI1	Blister A



SA1021



Sluiring DIN 9021
Rondelle DIN 9021
Flat washer DIN 9021
Scheibe DIN 9021

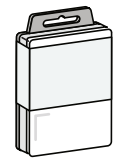

d [mm]	d _e [mm]	Art. ref.	EAN code			Price code	Packaging
M 3	9	SA1021030009	5410439123259	30	12	SA1	Blister A
M 4	12	SA1021040012	5410439123266	30	12	SC1	Blister A
M 5	15	SA1021050015	5410439123273	20	12	SD1	Blister A
M 6	18	SA1021060018	5410439123280	20	12	SC1	Blister A
M 8	24	SA1021080025	5410439123297	10	12	SD1	Blister A
M 10	30	SA1021100030	5410439123303	5	12	SD1	Blister A
M 12	37	SA1021120037	5410439701426	4	12	SF1	Blister A
M 14	44	SA1021140045	5410439277211	4	12	SG1	Blister A
M 16	50	SA1021160050	5410439277228	4	12	SH1	Blister A



SA0021



Sluiring DIN 9021
Rondelle DIN 9021
Flat washer DIN 9021
Scheibe DIN 9021

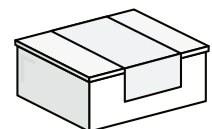

d [mm]	d _e [mm]	Art. ref.	EAN code			Price code	Packaging
M 4	12	SA0021040012	5410439173957	50	3	SD1	Box 1A



A2
Inox

SA0021

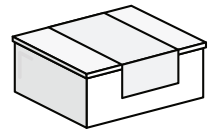

Sluitring DIN 9021
Rondelle DIN 9021
Flat washer DIN 9021
Scheibe DIN 9021





d [mm]	d _e [mm]	Art. ref.	EAN code			Price code	Packaging
M 5	15	SA0021050015	5410439175913	50	3	SE1	Box 1A
M 6	18	SA0021060018	5410439175906	50	3	SH1	Box 1A
M 8	24	SA0021080025	5410439175890	25	3	SH1	Box 1A
M 10	30	SA0021100030	5410439175883	15	3	SH3	Box 1A
M 12	37	SA0021120040	5410439175876	6	3	SH1	Box 1A

SB1021

A4
Inox

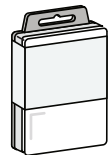
Sluitring DIN 9021
Rondelle DIN 9021
Flat washer DIN 9021
Scheibe DIN 9021





d [mm]	d _e [mm]	Art. ref.	EAN code			Price code	Packaging
M 4	12	SB1021040012	5410439046831	20	12	SC1	B blister A
M 5	15	SB1021050015	5410439046848	16	12	SD1	B blister A
M 6	18	SB1021060018	5410439046855	12	12	SC1	B blister A
M 8	24	SB1021080025	5410439046862	8	12	SD1	B blister A
M 10	30	SB1021100030	5410439046879	4	12	SD1	B blister A
M 12	37	SB1021120037	5410439046886	4	12	SF1	B blister A
M 14	44	SB1021140045	5410439046893	4	6	SH1	B blister B
M 16	50	SB1021160050	5410439046909	4	3	SI1	B blister E
M 18	56	SB1021180055	5410439046916	2	3	SJ1	B blister E
M 20	60	SB1021200060	5410439046923	2	3	SI1	B blister E

SA1127

A2
Inox

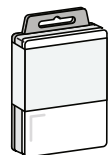
Veerring DIN 127B
Rondel ressort DIN 127B
Spring washer DIN 127B
Federringe DIN 127B



d [mm]	d _e [mm]	Art. ref.	EAN code			Price code	Packaging
M 3	6,2	SA1127030000	5410439397216	20	12	SB1	B blister A
M 4	7,6	SA1127040000	5410439397223	20	12	SB1	B blister A
M 5	9,2	SA1127050000	5410439397230	15	12	SB1	B blister A
M 6	11,8	SA1127060000	5410439397247	15	12	SB1	B blister A
M 8	14,8	SA1127080000	5410439397254	10	12	SB1	B blister A



A2
Inox

SA1127

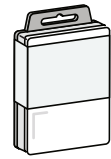

Veerring DIN 127B
Rondel ressort DIN 127B
Spring washer DIN 127B
Federringe DIN 127B





d [mm]	d _e [mm]	Art. ref.	EAN code			Price code	Packaging
M 10	18,1	SA1127100000	5410439397261	10	12	SB1	Blister A
M 12	21,1	SA1127120000	5410439123228	8	12	SC1	Blister A
M 14	21,1	SA1127140000	5410439035972	8	12	SC1	Blister A
M 16	27,4	SA1127160000	5410439123211	8	12	SE1	Blister A

SA0127

A2
Inox

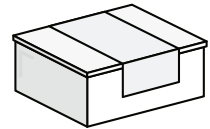
Veerring DIN 127B
Rondel ressort DIN 127B
Spring washer DIN 127B
Federringe DIN 127B





d [mm]	d _e [mm]	Art. ref.	EAN code			Price code	Packaging
M 3	6,2	SA0127030000	5410439347211	100	3	SE1	Box 1A
M 4	7,6	SA0127040000	5410439347228	100	3	SE1	Box 1A
M 5	9,2	SA0127050000	5410439347235	100	3	SG1	Box 1A
M 6	11,8	SA0127060000	5410439347242	100	3	SI1	Box 1A
M 8	14,8	SA0127080000	5410439347259	50	3	SH3	Box 1A
M 10	18,1	SA0127100000	5410439347266	25	3	SG1	Box 1A

SB1127

A4
Inox

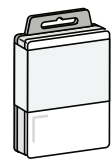
Veerring DIN 127B
Rondel ressort DIN 127B
Spring washer DIN 127B
Federringe DIN 127B



d [mm]	d _e [mm]	Art. ref.	EAN code			Price code	Packaging
M 4	7,6	SB1127040000	5410439047296	12	12	SB1	Blister A
M 5	9,2	SB1127050000	5410439047319	12	12	SB1	Blister A
M 6	11,8	SB1127060000	5410439047333	12	12	SB1	Blister A
M 8	14,8	SB1127080000	5410439047357	8	12	SB1	Blister A
M 10	18,1	SB1127100000	5410439047371	8	12	SB1	Blister A
M 12	21,1	SB1127120000	5410439047395	8	12	SC1	Blister A





SA10NR



Neopreensluitring
Rondelle étanche
EPDM bonded washer
Dichtscheibe EPDM



d [mm]	d _e [mm]	Art. ref.	EAN code			Price code	Packaging
6,8	16	SA10NR063016	5410439436748	20	12	SD1	Blister A
6,8	19	SA10NR063019	5410439436755	20	12	SE1	Blister A
6,8	25	SA10NR063025	5410439436762	20	6	SG1	Blister B

BINNENZESKANTSSCHROEVEN
VIS À 6 PANS CREUX
SOCKET SCREWS
INNERSECHSKANTSCHRAUBE

SB1912



Binnenzeskantbout met cilindrische kop DIN 912

Vis à six pans creux à tête cylindrique DIN 912

Socket cap screw DIN 912

Innensechskantschraube DIN 912

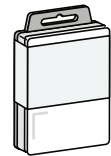

d [mm]	l [mm]	Art. ref.	EAN code			Price code	Packaging
M 4	16	SB1912040016	5410439049412	10	12	SB1	Blister A
M 5	16	SB1912050016	5410439049429	10	12	SC1	Blister A
M 5	20	SB1912050020	5410439049436	10	12	SC1	Blister A
M 5	30	SB1912050030	5410439049443	10	12	SD1	Blister A
M 6	16	SB1912060016	5410439049450	10	12	SD1	Blister A
M 6	20	SB1912060020	5410439049467	10	12	SD1	Blister A
M 6	30	SB1912060030	5410439049818	8	12	SD1	Blister A
M 6	40	SB1912060040	5410439049832	8	12	SE1	Blister A
M 6	60	SB1912060060	5410439048538	6	12	SE1	Blister A
M 8	20	SB1912080020	5410439050555	6	6	SE1	Blister B
M 8	30	SB1912080030	5410439051897	6	6	SF1	Blister B
M 8	40	SB1912080040	5410439051910	6	6	SH1	Blister B
M 8	50	SB1912080050	5410439051934	6	6	SH3	Blister B
M 10	30	SB1912100030	5410439050487	4	6	SG1	Blister B
M 10	40	SB1912100040	5410439050500	4	6	SH1	Blister B
M 10	50	SB1912100050	5410439050531	4	6	SI1	Blister B

SB1991



Binnenzeskantbout met verzonken kop DIN 7991

Vis à 6 pans creux DIN 7991

Countersunk screw DIN 7991

Senkkopfschraube DIN 7991

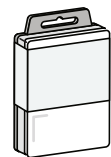

d [mm]	l [mm]	Art. ref.	EAN code			Price code	Packaging
M 4	16	SB1991040016	5410439049474	10	12	SB1	Blister A
M 5	16	SB1991050016	5410439051613	10	12	SB1	Blister A
M 5	20	SB1991050020	5410439049580	10	12	SC1	Blister A
M 5	30	SB1991050030	5410439049597	10	12	SD1	Blister A
M 6	16	SB1991060016	5410439049603	10	12	SC1	Blister A
M 6	20	SB1991060020	5410439049634	10	12	SC1	Blister A
M 6	30	SB1991060030	5410439049863	8	12	SD1	Blister A

SB1991





Binnenzeskantbout met verzonken kop DIN 7991

Vis à 6 pans creux DIN 7991

Countersunk screw DIN 7991

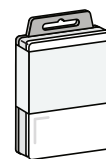
Senkkopfschraube DIN 7991



d [mm]	l [mm]	Art. ref.	EAN code			Price code	Packaging
M 6	40	SB1991060040	5410439049894	8	12	SE1	Blister A
M 6	60	SB1991060060	5410439048569	6	12	SE1	Blister A
M 8	20	SB1991080020	5410439051965	6	6	SD1	Blister B
M 8	30	SB1991080030	5410439052016	6	6	SE1	Blister B
M 8	40	SB1991080040	5410439052061	6	6	SF1	Blister B
M 8	50	SB1991080050	5410439052092	6	6	SH1	Blister B
M 10	30	SB1991100030	5410439052115	6	6	SH3	Blister B
M 10	40	SB1991100040	5410439052146	6	6	SI1	Blister B
M 10	50	SB1991100050	5410439052177	6	6	SJ1	Blister B

METAALSCROEF
VIS À MÉTAUX
METAL SCREWS
METALLSCHRAUBEN

SA1084





Schroef met cilindrische kop met moer DIN 7985/934

Vis à tête cylindrique avec écrou DIN 7985/934

Cheese head screw with nut DIN 7985/934

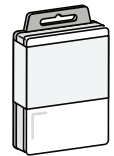
Zylinderkopfschraube mit Mutter DIN 7985/934



d [mm]	l [mm]	Art. ref.	EAN code			Price code	Packaging
M 3	10	SA1084030010	5410439397315	10	12	SB1	Blister A
M 3	12	SA1084030012	5410439397322	10	12	SB1	Blister A
M 3	16	SA1084030016	5410439397339	10	12	SB1	Blister A
M 3	20	SA1084030020	5410439397346	8	12	SB1	Blister A
M 3	25	SA1084030025	5410439397353	8	12	SB1	Blister A
M 4	10	SA1084040010	5410439397414	10	12	SB1	Blister A
M 4	12	SA1084040012	5410439397421	10	12	SB1	Blister A
M 4	16	SA1084040016	5410439397438	10	12	SB1	Blister A
M 4	20	SA1084040020	5410439397445	8	12	SB1	Blister A
M 4	25	SA1084040025	5410439397452	8	12	SB1	Blister A
M 4	30	SA1084040030	5410439397469	6	12	SB1	Blister A
M 5	10	SA1084050010	5410439397513	10	12	SD1	Blister A
M 5	12	SA1084050012	5410439397520	10	12	SD1	Blister A
M 5	16	SA1084050016	5410439397537	10	12	SD1	Blister A
M 5	20	SA1084050020	5410439397544	8	12	SD1	Blister A
M 5	25	SA1084050025	5410439397551	8	12	SD1	Blister A
M 5	30	SA1084050030	5410439397568	6	12	SD1	Blister A
M 5	35	SA1084050035	5410439397575	5	12	SD1	Blister A
M 5	40	SA1084050040	5410439397582	4	12	SD1	Blister A
M 6	16	SA1084060016	5410439397612	6	12	SD1	Blister A
M 6	20	SA1084060020	5410439397629	6	12	SD1	Blister A
M 6	25	SA1084060025	5410439397636	6	12	SD1	Blister A
M 6	30	SA1084060030	5410439397643	4	12	SD1	Blister A
M 6	40	SA1084060040	5410439397667	4	12	SD1	Blister A



SA0084





Schroef met cilindrische kop met moer DIN 7985/934

Vis à tête cylindrique avec écrou DIN 7985/934

Cheese head screw with nut DIN 7985/934

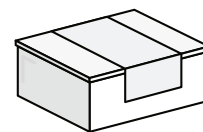
Zylinderkopfschraube mit Mutter DIN 7985/934



d [mm]	l [mm]	Art. ref.	EAN code			Price code	Packaging
M 3	10	SA0084030010	5410439347310	100	3	SK1	Box 1A
M 3	12	SA0084030012	5410439347327	100	3	SL1	Box 1A
M 3	16	SA0084030016	5410439347334	100	3	SL1	Box 1A
M 3	20	SA0084030020	5410439347341	100	3	SN1	Box 1A
M 3	25	SA0084030025	5410439347358	100	3	SN1	Box 1A
M 4	10	SA0084040010	5410439347419	100	3	SN1	Box 1A
M 4	12	SA0084040012	5410439347426	100	3	S01	Box 1A
M 4	16	SA0084040016	5410439347433	50	3	SJ1	Box 1A
M 4	20	SA0084040020	5410439347440	50	3	SJ1	Box 1A
M 4	25	SA0084040025	5410439347457	50	3	SL1	Box 1A
M 4	30	SA0084040030	5410439347464	50	3	SM1	Box 1A
M 5	10	SA0084050010	5410439347518	50	3	SL1	Box 1A
M 5	12	SA0084050012	5410439347525	50	3	SL1	Box 1A
M 5	16	SA0084050016	5410439347532	50	3	SL1	Box 1A
M 5	20	SA0084050020	5410439347549	25	3	SI1	Box 1A
M 5	25	SA0084050025	5410439347556	25	3	SJ1	Box 1A
M 5	30	SA0084050030	5410439347563	25	3	SK1	Box 1A
M 5	40	SA0084050040	5410439347587	25	3	SK1	Box 1A
M 6	16	SA0084060016	5410439347617	25	3	SJ1	Box 1A
M 6	20	SA0084060020	5410439347624	25	3	SJ1	Box 1A
M 6	25	SA0084060025	5410439347631	25	3	SK1	Box 1A
M 6	30	SA0084060030	5410439347648	25	3	SN1	Box 1A
M 6	40	SA0084060040	5410439347662	25	3	S01	Box 1A

SA1963





Schroef met verzonken kop met moer DIN 965/934

Vis à tête fraisée avec écrou DIN 965/934

Countersunk head screw with nut DIN 965/934

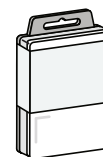
Senkkopfschraube mit Mutter DIN 965/934



d [mm]	l [mm]	Art. ref.	EAN code			Price code	Packaging
M 3	10	SA1963030010	5410439396318	10	12	SB1	Blisters A
M 3	12	SA1963030012	5410439396325	10	12	SB1	Blisters A
M 3	16	SA1963030016	5410439396332	10	12	SB1	Blisters A
M 3	20	SA1963030020	5410439396349	8	12	SB1	Blisters A
M 3	25	SA1963030025	5410439396356	8	12	SB1	Blisters A
M 4	10	SA1963040010	5410439396417	10	12	SB1	Blisters A
M 4	12	SA1963040012	5410439396424	10	12	SB1	Blisters A



SA1963



Schroef met verzonken kop met moer DIN 965/934

Vis à tête fraisée avec écrou DIN 965/934

Countersunk head screw with nut DIN 965/934

Senkkopfschraube mit Mutter DIN 965/934

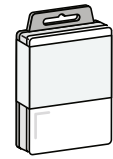

d [mm]	l [mm]	Art. ref.	EAN code			Price code	Packaging
M 4	16	SA1963040016	5410439396431	10	12	SB1	Blister A
M 4	20	SA1963040020	5410439396448	8	12	SB1	Blister A
M 4	25	SA1963040025	5410439396455	8	12	SB1	Blister A
M 4	30	SA1963040030	5410439396462	6	12	SB1	Blister A
M 5	10	SA1963050010	5410439396516	10	12	SD1	Blister A
M 5	12	SA1963050012	5410439396523	10	12	SD1	Blister A
M 5	16	SA1963050016	5410439396530	10	12	SD1	Blister A
M 5	20	SA1963050020	5410439396547	8	12	SD1	Blister A
M 5	25	SA1963050025	5410439396554	8	12	SD1	Blister A
M 5	30	SA1963050030	5410439396561	6	12	SD1	Blister A
M 5	40	SA1963050040	5410439396585	4	12	SD1	Blister A
M 6	16	SA1963060016	5410439396615	6	12	SD1	Blister A
M 6	20	SA1963060020	5410439396622	6	12	SD1	Blister A
M 6	25	SA1963060025	5410439396639	6	12	SD1	Blister A
M 6	30	SA1963060030	5410439396646	4	12	SD1	Blister A
M 6	40	SA1963060040	5410439396660	4	12	SD1	Blister A

SA0965



Schroef met verzonken kop met moer DIN 965/934

Vis à tête fraisée avec écrou DIN 965/934

Countersunk head screw with nut DIN 965/934

Senkkopfschraube mit Mutter DIN 965/934

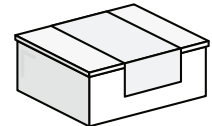

d [mm]	l [mm]	Art. ref.	EAN code			Price code	Packaging
M 3	10	SA0965030010	5410439346313	100	3	SL1	Box 1A
M 3	12	SA0965030012	5410439346320	100	3	SK1	Box 1A
M 3	16	SA0965030016	5410439346337	100	3	SL1	Box 1A
M 3	20	SA0965030020	5410439346344	100	3	SM1	Box 1A
M 3	25	SA0965030025	5410439346351	100	3	SN1	Box 1A
M 4	10	SA0965040010	5410439346412	100	3	SL1	Box 1A
M 4	12	SA0965040012	5410439346429	100	3	SN1	Box 1A
M 4	16	SA0965040016	5410439346436	50	3	SJ1	Box 1A
M 4	20	SA0965040020	5410439346443	50	3	SJ1	Box 1A
M 4	25	SA0965040025	5410439346450	50	3	SK1	Box 1A
M 4	30	SA0965040030	5410439346467	50	3	SK1	Box 1A
M 5	10	SA0965050010	5410439346511	50	3	SK1	Box 1A
M 5	12	SA0965050012	5410439346528	50	3	SK1	Box 1A
M 5	16	SA0965050016	5410439346535	50	3	SK1	Box 1A

SA0965





Schroef met verzonken kop met moer DIN 965/934

Vis à tête fraisée avec écrou DIN 965/934

Countersunk head screw with nut DIN 965/934

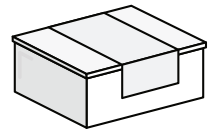
Senkkopfschraube mit Mutter DIN 965/934



d [mm]	l [mm]	Art. ref.	EAN code			Price code	Packaging
M 5	20	SA0965050020	5410439346542	25	3	SH3	Box 1A
M 5	25	SA0965050025	5410439346559	25	3	SH3	Box 1A
M 5	30	SA0965050030	5410439346566	25	3	SI1	Box 1A
M 5	40	SA0965050040	5410439346580	25	3	SJ1	Box 1A
M 6	16	SA0965060016	5410439346610	25	3	SI1	Box 1A
M 6	20	SA0965060020	5410439346627	25	3	SK1	Box 1A
M 6	25	SA0965060025	5410439346634	25	3	SK1	Box 1A
M 6	30	SA0965060030	5410439346641	25	3	SK1	Box 1A
M 6	40	SA0965060040	5410439346665	25	3	SM1	Box 1A

DIVERSE KOPVORMEN
DIVERSES FORMES DE TÊTE
VARIOUS HEAD FORMS
VERSCHIEDENE KOPFFORMEN

SB1582



Oogmoer DIN 582
Ecrou à anneau DIN 582
Lifting eye nut DIN 582
Ringmutter DIN 582

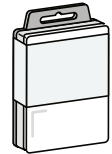

d [mm]	Art. ref.	EAN code			Price code	Packaging
M 6	SB1582060000	5410439049986	1	6	SE1	Blister B
M 8	SB1582080000	5410439050012	1	6	SG1	Blister B
M 10	SB1582100000	5410439050043	1	6	SJ1	Blister B
M 12	SB1582120000	5410439052337	1	1	SR1	Blister 2
M 16	SB1582160000	5410439052368	1	1	SV1	Blister 2

SB1580



Oogbout DIN 580
Vis à anneau DIN 580
Lifting eye bolt DIN 580
Ringschraube DIN 580

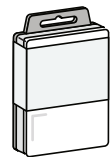

d [mm]	l [mm]	Art. ref.	EAN code			Price code	Packaging
M 6	13	SB1580060000	5410439049917	1	6	SE1	Blister B
M 8	13	SB1580080000	5410439049948	1	6	SG1	Blister B
M 10	17	SB1580100000	5410439049962	1	6	SK1	Blister B
M 12	20,5	SB1580120000	5410439052238	1	1	SS1	Blister 2
M 16	27	SB1580160000	5410439052313	1	1	SX1	Blister 2

ZELFBORENDE SCHROEVEN
VIS AUTOFORANTE
SELFD RILLING SCREWS
BOHRSCHRAUBEN



SA1981



Plaatschroef met cilindrische kop DIN 7981
Vis taraudeuse à tête cylindrique DIN 7981
Tapping screw with cylindrical head DIN 7981
Blechschaube mit zylindrischem Kopf DIN 7981

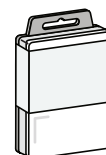

d [mm]	l [mm]	Art. ref.	EAN code			Price code	Packaging
3,5	9,5	SA1981035009	5410439396714	10	12	SB1	Blister A
3,5	13	SA1981035013	5410439396721	10	12	SB1	Blister A
3,5	16	SA1981035016	5410439396738	10	12	SB1	Blister A
3,5	19	SA1981035019	5410439396745	10	12	SB1	Blister A
3,5	22	SA1981035022	5410439396752	8	12	SB1	Blister A
3,5	25	SA1981035025	5410439396769	6	12	SB1	Blister A
4,2	9,5	SA1981042009	5410439396813	10	12	SB1	Blister A
4,2	13	SA1981042013	5410439396820	10	12	SB1	Blister A
4,2	16	SA1981042016	5410439396837	10	12	SB1	Blister A
4,2	19	SA1981042019	5410439396844	10	12	SB1	Blister A
4,2	22	SA1981042022	5410439396851	8	12	SB1	Blister A
4,2	25	SA1981042025	5410439396868	6	12	SB1	Blister A
4,2	32	SA1981042032	5410439396875	6	12	SB1	Blister A
4,8	13	SA1981048013	5410439396912	10	12	SB1	Blister A
4,8	16	SA1981048016	5410439396929	10	12	SB1	Blister A
4,8	19	SA1981048019	5410439396936	10	12	SB1	Blister A
4,8	22	SA1981048022	5410439396943	8	12	SB1	Blister A
4,8	25	SA1981048025	5410439396950	6	12	SB1	Blister A
4,8	32	SA1981048032	5410439396967	6	12	SB1	Blister A

SA0981



Plaatschroef met cilindrische kop DIN 7981
Vis taraudeuse à tête cylindrique DIN 7981
Tapping screw with cylindrical head DIN 7981
Blechschaube mit zylindrischem Kopf DIN 7981

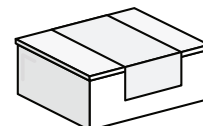

d [mm]	l [mm]	Art. ref.	EAN code			Price code	Packaging
3,5	9,5	SA0981035009	5410439346719	100	3	SJ1	Box 1A
3,5	13	SA0981035013	5410439346726	100	3	SJ1	Box 1A
3,5	16	SA0981035016	5410439346733	100	3	SJ1	Box 1A
3,5	19	SA0981035019	5410439346740	100	3	SK1	Box 1A





SA0981

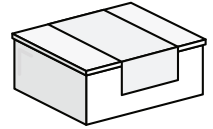

Plaatschroef met cilindrische kop DIN 7981
 Vis taraudeuse à tête cylindrique DIN 7981
 Tapping screw with cylindrical head DIN 7981
 Blechschraube mit zylindrischem Kopf DIN 7981





d [mm]	l [mm]	Art. ref.	EAN code			Price code	Packaging
3,5	22	SA0981035022	5410439346757	100	3	SK1	Box 1A
3,5	25	SA0981035025	5410439346764	100	3	SK1	Box 1A
4,2	9,5	SA0981042009	5410439346818	100	3	SJ1	Box 1A
4,2	13	SA0981042013	5410439346825	100	3	SJ1	Box 1A
4,2	16	SA0981042016	5410439346832	100	3	SK1	Box 1A
4,2	19	SA0981042019	5410439346849	100	3	SL1	Box 1A
4,2	22	SA0981042022	5410439346856	100	3	SM1	Box 1A
4,2	25	SA0981042025	5410439346863	100	3	SO1	Box 1A
4,2	32	SA0981042032	5410439346870	50	3	SJ1	Box 1A
4,8	13	SA0981048013	5410439346917	100	3	SM1	Box 1A
4,8	16	SA0981048016	5410439346924	100	3	SM1	Box 1A
4,8	19	SA0981048019	5410439346931	100	3	SN1	Box 1A
4,8	22	SA0981048022	5410439346948	50	3	SJ1	Box 1A
4,8	25	SA0981048025	5410439346955	50	3	SJ1	Box 1A
4,8	32	SA0981048032	5410439346962	50	3	SK1	Box 1A

SA104K

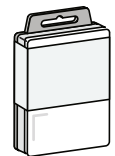

Zelfborende schroef DIN 7504K
 Vis autoforante DIN 7504K
 Selfdrilling screw DIN 7504K
 Bohrschraube DIN 7504K



d [mm]	l [mm]	Art. ref.	EAN code			Price code	Packaging
4,2	13	SA104K042013	5410439063364	20	12	SF1	Blister A
4,2	16	SA104K042016	5410439066235	20	12	SG1	Blister A
4,2	19	SA104K042019	5410439066273	20	12	SH1	Blister A
4,8	25	SA104K048025	5410439066303	20	6	SH1	Blister B
4,8	32	SA104K048032	5410439066334	20	6	SH3	Blister B
4,8	38	SA104K048038	5410439066358	20	6	SI1	Blister B
5,5	19	SA104K055019	5410439066396	20	6	SJ1	Blister B
5,5	25	SA104K055025	5410439066402	20	6	SJ1	Blister B
6,3	19	SA104K063019	5410439066426	10	6	SH1	Blister B
6,3	25	SA104K063025	5410439066464	10	6	SH3	Blister B
6,3	32	SA104K063032	5410439066495	10	6	SH3	Blister B
6,3	38	SA104K063038	5410439066525	10	6	SJ1	Blister B
6,3	50	SA104K063050	5410439066563	10	6	SK1	Blister B

HOUTSCHROEVEN
VIS À BOIS
WOOD SCREWS
HOLZSCHRAUBEN



SA1571



Houtdraadbout DIN 571
 Tirefond tête hexagonal DIN 571
 Hexagon coach screw DIN 571
 Sechskant-Holzschraube DIN 571

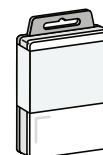

d [mm]	l [mm]	Art. ref.	EAN code			Price code	Packaging
6	30	SA1571060030	5410439370004	7	12	SE1	Blister A
6	40	SA1571060040	5410439370011	7	12	SE1	Blister A
6	50	SA1571060050	5410439370028	6	12	SE1	Blister A
6	60	SA1571060060	5410439370035	5	12	SE1	Blister A
8	50	SA1571080050	5410439370042	4	6	SF1	Blister B
8	60	SA1571080060	5410439370059	3	6	SF1	Blister B
8	80	SA1571080080	5410439121996	4	3	SI1	Blister E
8	100	SA1571080100	5410439122009	3	3	SJ1	Blister E
10	60	SA1571100060	5410439370080	3	6	SJ1	Blister B
10	80	SA1571100080	5410439122016	3	3	SJ1	Blister E
10	100	SA1571100100	5410439122023	2	3	SH3	Blister E
12	80	SA1571120080	5410439122030	2	3	SH3	Blister E
12	100	SA1571120100	5410439122047	2	3	SJ1	Blister E

SA0571



Houtdraadbout DIN 571
 Tirefond tête hexagonal DIN 571
 Hexagon coach screw DIN 571
 Sechskant-Holzschraube DIN 571

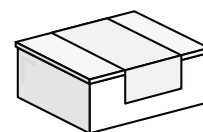



d [mm]	l [mm]	Art. ref.	EAN code			Price code	Packaging
6	30	SA0571060030	5410439253314	20	3	SM1	Box 1A
6	40	SA0571060040	5410439311687	20	3	SN1	Box 1A
6	60	SA0571060060	5410439311694	20	3	SP1	Box 1A
8	50	SA0571080050	5410439311700	20	3	SV1	Box 2A
8	60	SA0571080060	5410439311717	20	1	SX1	Box 3A
8	80	SA0571080080	5410439311724	15	3	SW1	Box 2A
8	100	SA0571080100	5410439311731	10	1	SS1	Box 4A
10	60	SA0571100060	5410439311748	10	3	SX1	Box 2A
10	80	SA0571100080	5410439311755	10	3	SX1	Box 2A
10	100	SA0571100100	5410439311762	8	1	SW1	Box 4A

SA1603

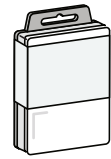

Houtbout DIN 603/555
 Boulon à bois DIN 603/555
 Carriage bolt DIN 603/555
 Flachrundschaube DIN 603/555





d [mm]	l [mm]	Art. ref.	EAN code			Price code	Packaging
M 6	30	SA1603060030	5410439371001	5	6	SH1	Blister B
M 6	40	SA1603060040	5410439371018	4	6	SH3	Blister B
M 6	50	SA1603060050	5410439371025	4	6	SH3	Blister B
M 6	60	SA1603060060	5410439371032	3	6	SH3	Blister B
M 6	80	SA1603060080	5410439122054	4	3	SH3	Blister E
M 8	50	SA1603080050	5410439371056	4	6	SM1	Blister B
M 8	60	SA1603080060	5410439371063	4	6	SM1	Blister B
M 8	70	SA1603080070	5410439371070	4	6	SN1	Blister B
M 8	80	SA1603080080	5410439122061	4	3	SO1	Blister E
M 8	100	SA1603080100	5410439122078	4	3	SP1	Blister E
M 10	60	SA1603100060	5410439371100	3	6	SO1	Blister B
M 10	80	SA1603100080	5410439124782	2	1	SO1	Blister 2
M 10	100	SA1603100100	5410439124799	2	1	SO1	Blister 2

SA0603

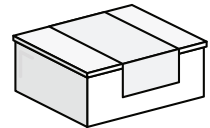

Houtbout DIN 603/555
 Boulon à bois DIN 603/555
 Carriage bolt DIN 603/555
 Flachrundschaube DIN 603/555



d [mm]	l [mm]	Art. ref.	EAN code			Price code	Packaging
M 6	40	SA0603060040	5410439253307	20	3	SO1	Box 2A
M 6	50	SA0603060050	5410439311113	20	3	SP1	Box 2A
M 6	60	SA0603060060	5410439311601	20	3	SR1	Box 2A
M 8	50	SA0603080050	5410439311618	20	3	SX1	Box 2A
M 8	60	SA0603080060	5410439311625	16	3	SW1	Box 2A
M 8	80	SA0603080080	5410439311632	15	1	SY1	Box 3A
M 8	100	SA0603080100	5410439311649	10	1	SV1	Box 4A
M 10	60	SA0603100060	5410439311656	10	1	SX1	Box 3A
M 10	70	SA0603100070	5410439426015	10	1	ST1	Box 3A
M 10	80	SA0603100080	5410439311663	10	1	SZ1	Box 4A
M 10	100	SA0603100100	5410439311670	10	1	SZ1	Box 4A

SA195R



Houtschroef DIN 7995 met EPDM sluitring
 Vis à bois DIN 7995 avec rondelle EPDM
 Wood screw DIN 7995 with EPDM washer
 Spenglerschraube DIN 7995 mit EPDM Scheibe

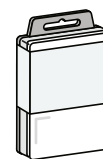

d [mm]	l [mm]	Art. ref.	EAN code			Price code	Packaging
4,5	25	SA195RT45025	5410439066600	10	6	SF1	Blister B
4,5	35	SA195RT45035	5410439066662	10	6	SF1	Blister B
4,5	40	SA195RT45040	5410439066709	10	6	SG1	Blister B
4,5	45	SA195RT45045	5410439066754	10	6	SH1	Blister B
4,5	50	SA195RT45050	5410439066792	6	6	SH1	Blister B
4,5	60	SA195RT45060	5410439066822	10	6	SE1	Blister B
4,5	70	SA195RT45070	5410439066860	10	3	SH1	Blister E

SA095R



Houtschroef DIN 7995 met EPDM sluitring
 Vis à bois DIN 7995 avec rondelle EPDM
 Wood screw DIN 7995 with EPDM washer
 Spenglerschraube DIN 7995 mit EPDM Scheibe

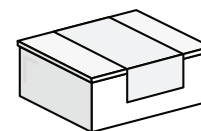

d [mm]	l [mm]	Art. ref.	EAN code			Price code	Packaging
4,5	35	SA095R045035	5410439324830	20	3	SH1	Box 1A
4,5	45	SA095R045045	5410439325042	20	3	SH3	Box 1A
4,5	65	SA095R045065	5410439325059	20	3	SK1	Box 2A
4,5	80	SA095R045080	5410439325066	20	3	SL1	Box 2A
4,5	100	SA095R045100	5410439325073	20	1	SN1	Box 4A
4,5	120	SA095R045120	5410439325080	20	1	SP1	Box 4A

SA10WP



Spaanderplaatschroef met verzonken kop
 Vis agglo à tête fraisée
 Chipboard screw with countersunk head
 Spanplattenschraube mit Senkkopf



d [mm]	l [mm]	Art. ref.	EAN code			Price code	Packaging
3	16	SA10WP030016	5410439398053	42	12	SG1	Blister A
3	20	SA10WP030020	5410439398060	38	12	SE1	Blister A
3	25	SA10WP030025	5410439398077	36	12	SE1	Blister A
3	30	SA10WP030030	5410439398084	34	12	SE1	Blister A
3,5	16	SA10WP035016	5410439398121	34	12	SF1	Blister A
3,5	20	SA10WP035020	5410439398138	33	12	SE1	Blister A
3,5	25	SA10WP035025	5410439398145	30	12	SF1	Blister A

SA10WP



Spaanderplaatschroef met verzonken kop
Vis agglo à tête fraisée
Chipboard screw with countersunk head
Spanplattenschraube mit Senkkopf

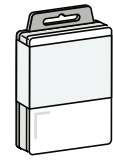

d [mm]	l [mm]	Art. ref.	EAN code			Price code	Packaging
3,5	30	SA10WP035030	5410439398152	28	12	SF1	Blister A
4	16	SA10WP040016	5410439398213	28	12	SG1	Blister A
4	20	SA10WP040020	5410439398220	26	12	SG1	Blister A
4	25	SA10WP040025	5410439398237	24	12	SH1	Blister A
4	30	SA10WP040030	5410439398244	23	12	SH3	Blister A
4	35	SA10WP040035	5410439398251	21	12	SF1	Blister A
4	40	SA10WP040040	5410439398268	19	12	SH3	Blister A
4	50	SA10WP040050	5410439398282	11	12	SE1	Blister A
4,5	20	SA10WP045020	5410439398312	20	12	SE1	Blister A
4,5	25	SA10WP045025	5410439398329	20	12	SE1	Blister A
4,5	30	SA10WP045030	5410439398336	17	12	SE1	Blister A
4,5	35	SA10WP045035	5410439398343	15	12	SE1	Blister A
4,5	40	SA10WP045040	5410439306959	13	12	SE1	Blister A
4,5	45	SA10WP045045	5410439398367	12	12	SE1	Blister A
4,5	50	SA10WP045050	5410439398374	11	12	SG1	Blister A
5	30	SA10WP050030	5410439398428	14	12	SH1	Blister A
5	40	SA10WP050040	5410439398442	11	12	SE1	Blister A
5	50	SA10WP050050	5410439398466	9	12	SE1	Blister A
5	60	SA10WP050060	5410439398473	7	12	SE1	Blister A
5	70	SA10WP050070	5410439398480	12	3	SH3	Blister E
5	80	SA10WP050080	5410439121965	10	3	SK1	Blister E
6	50	SA10WP060050	5410439398541	6	12	SG1	Blister A
6	60	SA10WP060060	5410439398558	5	12	SE1	Blister A
6	70	SA10WP060070	5410439121972	10	6	SH3	Blister B
6	80	SA10WP060080	5410439121989	8	3	SH3	Blister E

SA00WP



Spaanderplaatschroef met verzonken kop
Vis agglo à tête fraisée
Chipboard screw with countersunk head
Spanplattenschraube mit Senkkopf

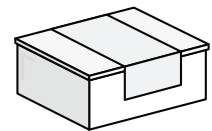

d [mm]	l [mm]	Art. ref.	EAN code			Price code	Packaging
3	16	SA00WP030016	5410439348058	100	3	SI1	Box 1A
3	20	SA00WP030020	5410439348065	100	3	SJ1	Box 1A
3	25	SA00WP030025	5410439348072	100	3	SJ1	Box 1A
3	30	SA00WP030030	5410439348089	100	3	SK1	Box 1A
3,5	16	SA00WP035016	5410439348126	100	3	SJ1	Box 1A





SA00WP

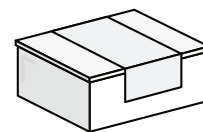

Spaanderplaatschroef met verzonken kop
 Vis agglo à tête fraisée
 Chipboard screw with countersunk head
 Spanplattenschraube mit Senkkopf



d [mm]	l [mm]	Art. ref.	EAN code			Price code	Packaging
3,5	20	SA00WP035020	5410439348133	100	3	SK1	Box 1A
3,5	25	SA00WP035025	5410439348140	100	3	SL1	Box 1A
3,5	30	SA00WP035030	5410439348157	100	3	SM1	Box 1A
3,5	35	SA00WP035035	5410439348164	100	3	SN1	Box 2A
3,5	40	SA00WP035040	5410439348171	100	3	SO1	Box 2A
4	16	SA00WP040016	5410439348218	100	3	SK1	Box 1A
4	20	SA00WP040020	5410439348225	100	3	SL1	Box 1A
4	25	SA00WP040025	5410439348232	100	3	SM1	Box 2A
4	30	SA00WP040030	5410439348249	100	3	SN1	Box 1A
4	35	SA00WP040035	5410439348256	100	3	SP1	Box 2A
4	40	SA00WP040040	5410439348263	100	3	SQ1	Box 2A
4	45	SA00WP040045	5410439348270	100	3	SS1	Box 2A
4	50	SA00WP040050	5410439348287	90	3	SS1	Box 2A
4,5	20	SA00WP045020	5410439348317	100	3	SN1	Box 1A
4,5	25	SA00WP045025	5410439348324	100	3	SO1	Box 2A
4,5	30	SA00WP045030	5410439348331	100	3	SQ1	Box 2A
4,5	35	SA00WP045035	5410439348348	100	3	SR1	Box 2A
4,5	40	SA00WP045040	5410439348355	90	1	SS1	Box 3A
4,5	45	SA00WP045045	5410439348362	80	3	SS1	Box 2A
4,5	50	SA00WP045050	5410439348379	70	3	SS1	Box 2A
5	30	SA00WP050030	5410439348423	70	3	SS1	Box 1A
5	35	SA00WP050035	5410439348430	80	3	SR1	Box 2A
5	40	SA00WP050040	5410439348447	70	3	SR1	Box 2A
5	50	SA00WP050050	5410439348461	50	3	SP1	Box 2A
5	60	SA00WP050060	5410439348478	50	1	SR1	Box 4A
5	70	SA00WP050070	5410439348485	45	1	SS1	Box 4A
5	80	SA00WP050080	5410439348492	35	1	SR1	Box 4A
6	40	SA00WP060040	5410439348522	50	3	SQ1	Box 2A
6	50	SA00WP060050	5410439348546	50	3	SR1	Box 2A
6	60	SA00WP060060	5410439348553	40	3	SR1	Box 2A
6	70	SA00WP060070	5410439348560	30	3	SR1	Box 2A
6	80	SA00WP060080	5410439348577	25	3	SR1	Box 2A
6	100	SA00WP060100	5410439348591	20	1	SR1	Box 4A

SA1TWP



Spaanderplaatschroef PFS+ met verzonken kop
 Vis agglo PFS+ à tête fraisée
 Chipboard screw PFS+ with countersunk head
 Spanplattenschraube PFS+ mit Senkkopf

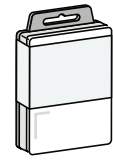

d [mm]	l [mm]	Art. ref.	EAN code			Price code	Packaging
4	25	SA1TWP040025	5410439067416	40	6	SI1	Blister B
4	30	SA1TWP040030	5410439067423	40	6	SI1	Blister B
4	35	SA1TWP040035	5410439067430	40	6	SJ1	Blister B
4	40	SA1TWP040040	5410439067126	40	6	SJ1	Blister B
4	45	SA1TWP040045	5410439067157	40	6	SK1	Blister B
4	50	SA1TWP040050	5410439067188	40	6	SK1	Blister B
4	60	SA1TWP040060	5410439067218	25	6	SI1	Blister B
4,5	50	SA1TWP045050	5410439067232	25	6	SI1	Blister B
4,5	60	SA1TWP045060	5410439067256	25	6	SJ1	Blister B
4,5	70	SA1TWP045070	5410439067263	25	3	SL1	Blister E
4,5	80	SA1TWP045080	5410439067287	25	3	SM1	Blister E
5	50	SA1TWP050050	5410439067300	20	6	SK1	Blister B
5	60	SA1TWP050060	5410439067317	20	6	SL1	Blister B
5	70	SA1TWP050070	5410439067324	20	3	SM1	Blister E
5	80	SA1TWP050080	5410439067331	20	3	SN1	Blister E
5	90	SA1TWP050090	5410439067355	20	3	SO1	Blister E
5	100	SA1TWP050100	5410439067362	20	3	SP1	Blister E
6	60	SA1TWP060060	5410439067379	10	6	SK1	Blister B
6	80	SA1TWP060080	5410439067386	10	3	SL1	Blister E
6	100	SA1TWP060100	5410439067393	10	3	SM1	Blister E
6	120	SA1TWP060120	5410439067409	10	3	SP1	Blister E

SB1TRS



HPL schroef platbolkop
 Vis pour panneaux HPL avec tête bombée
 HPL-screw trusshead
 HPL-Schrauben

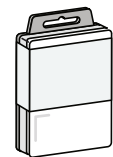

d [mm]	l [mm]	Art. ref.	EAN code	Colour			Price code	Packaging
4,8	25	SB1TRS250000	5410439069762		20	6	SL1	Blister B
4,8	25	SB1TRS257016	5410439069861	RAL 7016	20	6	SN1	Blister B
4,8	25	SB1TRS259005	5410439069878	RAL 9005	20	6	SN1	Blister B
4,8	25	SB1TRS259010	5410439069946	RAL 9010	20	6	SN1	Blister B
4,8	32	SB1TRS320000	5410439069823		20	6	SL1	Blister B
4,8	32	SB1TRS327016	5410439070201	RAL 7016	20	6	SO1	Blister B
4,8	32	SB1TRS329005	5410439070362	RAL 9005	20	6	SO1	Blister B
4,8	32	SB1TRS329010	5410439070386	RAL 9010	20	6	SO1	Blister B
4,8	38	SB1TRS380000	5410439069847		20	6	SL1	Blister B



SB1TRS



HPL schroef platbolkop
 Vis pour panneaux HPL avec tête bombée
 HPL-screw trusshead
 HPL-Schrauben



d [mm]	l [mm]	Art. ref.	EAN code	Colour			Price code	Packaging
4,8	38	SB1TRS387016	5410439070393	RAL 7016	20	6	SP1	Blister B
4,8	38	SB1TRS389005	5410439070409	RAL 9005	20	6	SP1	Blister B
4,8	38	SB1TRS389010	5410439070416	RAL 9010	20	6	SP1	Blister B

SA1TZB



Zelfborende spaanplaatschroef met verzonken kop
 Vis aggro autofrottant à tête fraisée
 Self-drilling chipboard screw with countersunk head
 Selbstbohrende Spanplattenschraube mit Senkkopf



d [mm]	l [mm]	Art. ref.	EAN code			Price code	Packaging
4	30	SA1TZB040030	5410439067447	20	6	SG1	Blister B
4	40	SA1TZB040040	5410439067454	20	6	SG1	Blister B
4,5	30	SA1TZB045030	5410439156493	20	6	SH1	Blister B
4,5	40	SA1TZB045040	5410439068185	20	6	SH3	Blister B
4,5	45	SA1TZB045045	5410439068345	20	6	SI1	Blister B
4,5	50	SA1TZB045050	5410439068352	20	6	SI1	Blister B
5	40	SA1TZB050040	5410439068437	20	6	SJ1	Blister B

SA1TTG



Houtconstructieschroef met flenskop PFS+
 Vis pour constructions en bois tête disque PFS+
 Wood construction screw with flange head PFS+
 Holzbauschraube mit Tellerkopf PFS+





d [mm]	l [mm]	Art. ref.	EAN code			Price code	Packaging
8	40	SA1TTG080040	5410439066907	4	6	SH3	Blister B
8	50	SA1TTG080050	5410439066945	4	6	SI1	Blister B
8	60	SA1TTG080060	5410439066983	4	6	SJ1	Blister B
8	80	SA1TTG080080	5410439067010	4	3	SK1	Blister E
8	100	SA1TTG080100	5410439067058	4	3	SL1	Blister E
8	120	SA1TTG080120	5410439067102	4	3	SL1	Blister E

SA10SO

A2
Inox

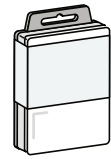
Schroefoog
Pitons fermés
Screw eyes for wood
schraubeösen





d [mm]	l [mm]	Art. ref.	EAN code			Price code	Packaging
3,5	20	SA10SO035020	5410439202824	4	12	SG1	Blister A
4	30	SA10SO040030	5410439202831	4	12	SH3	Blister A
4,5	40	SA10SO045040	5410439202848	2	12	SH3	Blister A

SA1MSO

A2
Inox

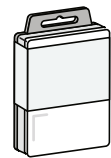
Metrisch Schroefoog & moer
Piton fermé métrique & écrou
Metric screw eye thread & nut
Schrauböse metrisch & mutter





d [mm]	l [mm]	Art. ref.	EAN code			Price code	Packaging
M 5	30	SA1MSO050030	5410439203111	2	12	SF1	Blister A
M 6	40	SA1MSO060040	5410439203128	2	12	SH3	Blister A

SA10SD

A2
Inox

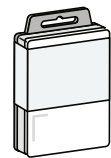
Schroefduim
Gond à vis
Unshouldered square hook
Gerade Schraubhaken





d [mm]	l [mm]	Art. ref.	EAN code			Price code	Packaging
3,5	40	SA10SD035040	5410439359283	2	12	SE1	Blister A
3,5	50	SA10SD035050	5410439359290	2	12	SF1	Blister A
4	60	SA10SD040060	5410439202855	2	12	SG1	Blister A

SA10SH

A2
Inox

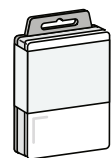
Schroefduim
Gond à vis
Unshouldered square hook
Gerade Schraubhaken



d [mm]	l [mm]	Art. ref.	EAN code			Price code	Packaging
3,5	20	SA10SH035020	5410439359252	2	12	SF1	Blister A
4,5	30	SA10SH045030	5410439202862	2	12	SH1	Blister A
4,5	50	SA10SH045050	5410439359269	2	12	SH3	Blister A



A2
Inox

SA10SH

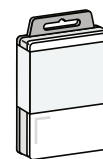

Schroefduim
Gond à vis
Unshouldered square hook
Gerade Schraubhaken



d [mm]	l [mm]	Art. ref.	EAN code			Price code	Packaging
5,2	60	SA10SH052060	5410439359276	2	3	SJ1	Blister E

A2
Inox

SA1MSH



Metrische schroefhaak & moer
Crochet d'armoire métrique & écrou
Metric cup hooks & nut
Schraubhaken metrisch & mutter



d [mm]	l [mm]	Art. ref.	EAN code			Price code	Packaging
M 6	50	SA1MSH060050	5410439203135	2	12	SH3	Blister A

NAGELS
POINTES
NAILS
STIFTEN

SA1NPK



Nagel DIN 1151B
Pointe DIN 1151B
Nail DIN 1151B
Flachkopfstifte DIN 1151B

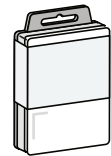

d [mm]	l [mm]	Art. ref.	EAN code			Price code	Packaging
1,2	20	SA1NPK012020	5410439399012	100 g	6	SL1	Blister B
1,6	25	SA1NPK015025	5410439399029	100 g	6	SL1	Blister B
1,8	30	SA1NPK018030	5410439399036	100 g	6	SL1	Blister B
2,1	40	SA1NPK020040	5410439399043	100 g	12	SK1	Blister A
2,4	50	SA1NPK027050	5410439399050	100 g	6	SK1	Blister B
3	65	SA1NPK027060	5410439399067	100 g	6	SK1	Blister A
3,4	80	SA1NPK035080	5410439121927	100 g	3	SK1	Blister E
4	100	SA1NPK045100	5410439121934	100 g	3	SK1	Blister E

SA0NPK



Nagel PK D1151B
Pointe TP DIN 1151B
Construction nail Countersunk DIN 1151B
Flachkopfstifte DIN 1151B

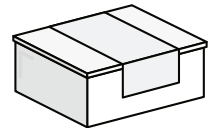

d [mm]	l [mm]	Art. ref.	EAN code			Price code	Packaging
1,2	20	SA0NPK012020	5410439387149	300 g	3	SV1	Box 2A
1,6	25	SA0NPK015025	5410439387156	300 g	3	SV1	Box 2A
1,8	30	SA0NPK018030	5410439387163	300 g	3	SV1	Box 2A
2,7	50	SA0NPK027050	5410439387170	300 g	3	SW1	Box 2A
3	60	SA0NPK027060	5410439387187	300 g	3	SW1	Box 1A
3,4	80	SA0NPK035080	5410439387194	300 g	3	SW1	Box 1A





SA1NRK

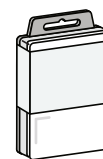

Nagel met ronde kop DIN 1152
 Pointe à tête ronde DIN 1152
 Finishing nail DIN 1152
 Stauchkopfstifte rund DIN 1152





d [mm]	l [mm]	Art. ref.	EAN code			Price code	Packaging
1,2	20	SA1NRK012020	5410439399104	100 g	6	SL1	Blister B
1,6	25	SA1NRK015025	5410439399111	100 g	12	SL1	Blister A
1,8	30	SA1NRK018030	5410439399128	100 g	6	SL1	Blister B
2,1	40	SA1NRK020040	5410439399135	100 g	6	SK1	Blister B
2,4	50	SA1NRK027050	5410439399142	100 g	6	SK1	Blister B
3	65	SA1NRK027060	5410439399159	100 g	6	SK1	Blister B
3,4	80	SA1NRK035080	5410439121941	100 g	3	SK1	Blister E

SA0NRK

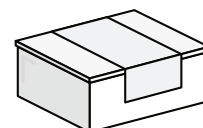

Nagel met ronde kop DIN 1152
 Pointe à tête ronde DIN 1152
 Finishing nail DIN 1152
 Stauchkopfstifte rund DIN 1152



d [mm]	l [mm]	Art. ref.	EAN code			Price code	Packaging
1,2	20	SA0NRK012020	5410439387200	300 g	3	SV1	Box 2A
1,6	25	SA0NRK015025	5410439387217	300 g	3	SV1	Box 2A
1,8	30	SA0NRK018030	5410439387224	300 g	3	SV1	Box 2A
2,1	40	SA0NRK021040	5410439389907	300 g	3	SV1	Box 2A
2,4	50	SA0NRK027050	5410439387231	300 g	3	SW1	Box 1A

PENNEN
GROUPLLES
PINS
SPLINTEN



SB1024

A4
Inox

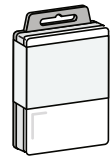

Standaard enkele borgveer
Goupille ressort simple
Spring pin single
Einfache Federstecker



d [mm]	l [mm]	Art. ref.	EAN code			Price code	Packaging
2	50	SB1024020050	5410439048477	4	12	SC1	Blister A
3	60	SB1024030060	5410439048194	3	12	SE1	Blister A
4	60	SB1024040080	5410439052207	3	3	SI1	Blister E



SB1094

A4
Inox

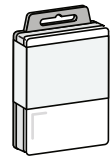

Splitpen DIN 94
Goupille fendue DIN 94
Cotter pin DIN 94
Splinte DIN 94





d [mm]	l [mm]	Art. ref.	EAN code			Price code	Packaging
1,6	20	SB1094016020	5410439049252	25	12	SC1	Blister A
2	25	SB1094020025	5410439049283	20	12	SC1	Blister A
2,5	32	SB1094025032	5410439049313	15	12	SC1	Blister A
3,2	40	SB1094032040	5410439049672	10	12	SC1	Blister A
4	50	SB1094040050	5410439049719	10	12	SE1	Blister A
5	63	SB1094050063	5410439048507	5	12	SE1	Blister A

KLINKNAGELS
RIVETS
RIVETS
NIETEN

SR137AA2
A2

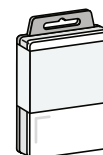
Blindklinknagel DIN 7337A
Rivet aveugle DIN 7337A
Blind rivet DIN 7337A
Blindniete DIN 7337A





d [mm]	l [mm]	Art. ref.	EAN code			Price code	Packaging
3	8	SR137A030008	5410439424721	10	12	SB1	Blister A
3	10	SR137A030010	5410439424738	10	12	SB1	Blister A
3	12	SR137A030012	5410439424745	10	12	SB1	Blister A
4	8	SR137A040008	5410439702195	10	12	SC1	Blister A
4	10	SR137A040010	5410439702201	10	12	SC1	Blister A
4	13	SR137A040013	5410439702218	10	12	SC1	Blister A
4	16	SR137A040016	5410439702225	10	12	SE1	Blister A
4	20	SR137A040020	5410439702232	10	12	SF1	Blister A
4,8	8	SR137A048008	5410439702249	10	12	SD1	Blister A
4,8	10	SR137A048010	5410439702256	10	12	SD1	Blister A
4,8	12	SR137A048012	5410439702263	10	12	SD1	Blister A
4,8	14	SR137A048014	5410439702270	10	12	SE1	Blister A
4,8	16	SR137A048016	5410439702287	10	12	SE1	Blister A

SA137AALU
A2

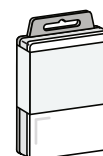
Blindklinknagel DIN 7337A
Rivet aveugle DIN 7337A
Blind rivet DIN 7337A
Blindniete DIN 7337A





d [mm]	l [mm]	Art. ref.	EAN code			Price code	Packaging
3	6	SA137A030006	5410439238076	10	12	SC1	Blister A
3	8	SA137A030008	5410439238083	10	12	SC1	Blister A
3	10	SA137A030010	5410439238090	10	12	SC1	Blister A
3	12	SA137A030012	5410439238106	10	12	SC1	Blister A
3,2	6	SA137A032006	5410439238113	10	12	SC1	Blister A
3,2	8	SA137A032008	5410439238120	10	12	SC1	Blister A
3,2	10	SA137A032010	5410439238137	10	12	SC1	Blister A
3,2	12	SA137A032012	5410439238144	10	12	SC1	Blister A
3,2	14	SA137A032014	5410439238151	10	12	SC1	Blister A
4	6	SA137A040006	5410439238168	10	12	SD1	Blister A

SA137A

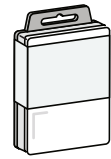

Blindklinknagel DIN 7337A
Rivet aveugle DIN 7337A
Blind rivet DIN 7337A
Blindniete DIN 7337A





d [mm]	l [mm]	Art. ref.	EAN code			Price code	Packaging
4	8	SA137A040008	5410439238175	10	12	SD1	Blister A
4	10	SA137A040010	5410439238182	10	12	SD1	Blister A
4	12	SA137A040012	5410439238199	10	12	SD1	Blister A
4	14	SA137A040014	5410439238205	10	12	SD1	Blister A
4	16	SA137A040016	5410439238212	10	12	SD1	Blister A
4	18	SA137A040018	5410439238229	10	12	SD1	Blister A
4	20	SA137A040020	5410439238236	10	12	SD1	Blister A
4,8	8	SA137A048008	5410439238267	10	12	SD1	Blister A
4,8	10	SA137A048010	5410439238274	10	12	SD1	Blister A
4,8	12	SA137A048012	5410439238281	10	12	SD1	Blister A
4,8	14	SA137A048014	5410439238298	10	12	SD1	Blister A
4,8	16	SA137A048016	5410439238304	10	12	SD1	Blister A
4,8	18	SA137A048018	5410439238311	10	12	SE1	Blister A
4,8	20	SA137A048020	5410439238328	10	12	SE1	Blister A

SA037A

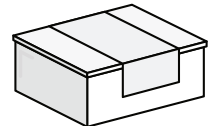

Blindklinknagel DIN 7337A
Rivet aveugle DIN 7337A
Blind rivet DIN 7337A
Blindniete DIN 7337A



d [mm]	l [mm]	Art. ref.	EAN code			Price code	Packaging
4	8	SA037A040008	5410439237178	100	3	SM1	Box 2A
4	10	SA037A040010	5410439237185	100	3	SM1	Box 2A
4,8	8	SA037A048008	5410439237208	100	3	SN1	Box 2A
4,8	10	SA037A048010	5410439237192	100	3	SN1	Box 2A
4,8	12	SA037A048012	5410439237215	100	3	SN1	Box 2A
4,8	14	SA037A048014	5410439237222	100	3	SP1	Box 2A



NYLON BEVESTIGINGEN
FIXATIONS EN NYLON
NYLON FASTENERS
BEFESTIGUNGEN AUS NYLON

BOLTS

SK1933			187
--------	---	---	-----

NUTS

SK1934			188
--------	---	---	-----

SK1315			188
--------	---	---	-----

SK1587			188
--------	---	---	-----

WASHERS

SK1125			190
--------	---	---	-----

MACHINE SCREWS

SK1084			191
--------	---	---	-----

SK1963			191
--------	---	---	-----



BOUTEN
VIS À TÊTE HEXAGONAL
BOLTS
SECHSKANTSCHRAUBE

SK1933

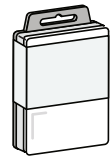

Zeskantbout met moer DIN 933/934
Vis à tête hexagonal avec écrou DIN 933/934
Hexagonal screw with nut DIN 933/934
Sechskantschraube mit Mutter DIN 933/934



d [mm]	l [mm]	Art. ref.	EAN code			Price code	Packaging
M 5	20	SK1933050020	5410439358033	8	12	SG1	Blister A
M 6	16	SK1933060016	5410439358118	8	12	SG1	Blister A
M 6	20	SK1933060020	5410439358125	6	12	SG1	Blister A
M 6	30	SK1933060030	5410439358149	4	12	SG1	Blister A
M 6	40	SK1933060040	5410439358156	4	12	SG1	Blister A
M 8	20	SK1933080020	5410439358217	4	6	SH1	Blister B
M 8	30	SK1933080030	5410439358231	4	6	SH1	Blister B
M 8	40	SK1933080040	5410439358248	4	6	SH1	Blister B
M 8	60	SK1933080060	5410439358262	4	6	SH1	Blister B

MOEREN
ÉCROUS
NUTS
MUTTERN

SK1934



Zeskantmoer DIN 934
Ecrou hexagonal DIN 934
Hexagon nut DIN 934
Sechskantmutter DIN 934

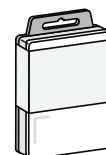

d [mm]	Art. ref.	EAN code			Price code	Packaging
M 3	SK1934030000	5410439357012	10	12	SG1	Blister A
M 4	SK1934040000	5410439357029	10	12	SG1	Blister A
M 5	SK1934050000	5410439357036	10	12	SG1	Blister A
M 6	SK1934060000	5410439357043	8	12	SG1	Blister A
M 8	SK1934080000	5410439357050	6	12	SG1	Blister A
M 10	SK1934100000	5410439357067	4	12	SG1	Blister A

SK1315



Vleugelmoer DIN 315
Ecrou à ailette DIN 315
Wing nut DIN 315
Flügelmutter DIN 315

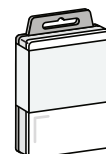

d [mm]	Art. ref.	EAN code			Price code	Packaging
M 4	SK1315040000	5410439357807	5	12	SH1	Blister A
M 5	SK1315050000	5410439357814	5	12	SH1	Blister A
M 6	SK1315060000	5410439357821	4	12	SH1	Blister A
M 8	SK1315080000	5410439357838	3	6	SH1	Blister B
M 10	SK1315100000	5410439357845	2	6	SH1	Blister B

SK1587



Zeskant dopmoer DIN 1587
Ecrou borgne hexagonal DIN 1587
Hexagonal domed cap nut DIN 1587
Sechskant-Hutmutter DIN 1587

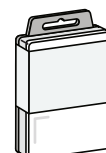

d [mm]	Art. ref.	EAN code			Price code	Packaging
M 4	SK1587040000	5410439357906	8	12	SD1	Blister A
M 5	SK1587050000	5410439357913	8	12	SD1	Blister A





SK1587

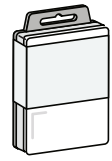

Zeskant dopmoer DIN 1587
 Ecrou borgne hexagonal DIN 1587
 Hexagonal domed cap nut DIN 1587
 Sechskant-Hutmutter DIN 1587



d [mm]	Art. ref.	EAN code			Price code	Packaging
M 6	SK1587060000	5410439357920	5	12	SD1	Blister A
M 8	SK1587080000	5410439357937	4	12	SD1	Blister A
M 10	SK1587100000	5410439357944	3	6	SD1	Blister B

SLUITRINGEN
 RONDELLES
 WASHERS
 SCHEIBEN





SK1125

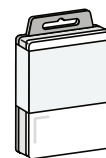

Sluitring DIN 125A
 Rondelle DIN 125A
 Washer DIN 125A
 Scheibe DIN 125A



d [mm]	d _e [mm]	Art. ref.	EAN code			Price code	Packaging
M 3	30	SK1125030000	5410439357111	30	12	SG1	Blister A
M 4	30	SK1125040000	5410439357128	25	12	SG1	Blister A
M 5	30	SK1125050000	5410439357135	20	12	SG1	Blister A
M 6	30	SK1125060000	5410439357142	16	12	SG1	Blister A
M 8	30	SK1125080000	5410439357159	10	12	SG1	Blister A
M 10	30	SK1125100000	5410439357166	6	12	SG1	Blister A

**METAALSCHROEF
VIS À MÉTAUX
METAL SCREWS
METALLSCHRAUBEN**

SK1084



Schroef met cilindrische kop met moer DIN 84/934
Vis à tête cylindrique avec écrou DIN 84/934
Cheese head screw with nut DIN 84/934
Zylinderkopfschraube mit Mutter DIN 84/934

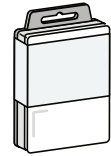

d [mm]	l [mm]	Art. ref.	EAN code			Price code	Packaging
M 3	10	SK1084030010	5410439357319	10	12	SG1	Blister A
M 3	16	SK1084030016	5410439357333	10	12	SG1	Blister A
M 3	20	SK1084030020	5410439357340	8	12	SG1	Blister A
M 4	10	SK1084040010	5410439357418	10	12	SG1	Blister A
M 4	12	SK1084040012	5410439357425	10	12	SG1	Blister A
M 4	16	SK1084040016	5410439357432	10	12	SG1	Blister A
M 4	20	SK1084040020	5410439357449	8	12	SG1	Blister A
M 4	25	SK1084040025	5410439357456	8	12	SG1	Blister A
M 4	30	SK1084040030	5410439357463	6	12	SG1	Blister A
M 5	10	SK1084050010	5410439357517	10	12	SH1	Blister A
M 5	16	SK1084050016	5410439357531	10	12	SH1	Blister A
M 5	20	SK1084050020	5410439357548	8	12	SH1	Blister A
M 5	30	SK1084050030	5410439357562	6	12	SH1	Blister A
M 6	16	SK1084060016	5410439357616	6	12	SH1	Blister A
M 6	20	SK1084060020	5410439357623	6	12	SH1	Blister A
M 6	25	SK1084060025	5410439357630	6	12	SH1	Blister A
M 6	30	SK1084060030	5410439357647	4	12	SH1	Blister A
M 6	40	SK1084060040	5410439357661	4	12	SH1	Blister A

SK1963



Schroef met verzonken kop met moer DIN 965/934
Vis à tête fraisée avec écrou DIN 965/934
Countersunk head screw with nut DIN 965/934
Senkkopfschraube mit Mutter DIN 965/934

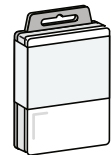

d [mm]	l [mm]	Art. ref.	EAN code			Price code	Packaging
M 3	10	SK1963030010	5410439358316	10	12	SG1	Blister A
M 3	16	SK1963030016	5410439358330	10	12	SG1	Blister A
M 3	20	SK1963030020	5410439358347	8	12	SG1	Blister A
M 4	10	SK1963040010	5410439358415	10	12	SG1	Blister A
M 4	12	SK1963040012	5410439358422	10	12	SG1	Blister A



SK1963





Schroef met verzonken kop met moer DIN 965/934

Vis à tête fraisée avec écrou DIN 965/934

Countersunk head screw with nut DIN 965/934

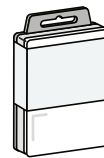
Senkkopfschraube mit Mutter DIN 965/934



















d [mm]	l [mm]	Art. ref.	EAN code			Price code	Packaging
M 4	16	SK1963040016	5410439358439	10	12	SG1	Blister A
M 4	20	SK1963040020	5410439358446	8	12	SG1	Blister A
M 4	25	SK1963040025	5410439358453	8	12	SG1	Blister A
M 4	30	SK1963040030	5410439358460	6	12	SG1	Blister A
M 5	10	SK1963050010	5410439358514	10	12	SH1	Blister A
M 5	16	SK1963050016	5410439358538	10	12	SH1	Blister A
M 5	20	SK1963050020	5410439358545	8	12	SH1	Blister A
M 5	30	SK1963050030	5410439358569	6	12	SH1	Blister A
M 6	16	SK1963060016	5410439358613	6	12	SH1	Blister A
M 6	20	SK1963060020	5410439358620	6	12	SH1	Blister A
M 6	25	SK1963060025	5410439358637	6	12	SH1	Blister A
M 6	30	SK1963060030	5410439358644	4	12	SH1	Blister A
M 6	40	SK1963060040	5410439358668	4	12	SH1	Blister A















NAGELS
POINTES
NAILS
BRAHTSTIFTE











STANDARD NAILS

RS1NPK			193
RS0NPK			193
RZ0NPK			194
RS1SZK			195
RZ0NRK			195
RS1NRK			195
RS0NRK			196
RM1NBK			197

























HARDENED NAILS

RT1NKK			198
RT0NKK			198
RT5NKK			199
RT1NPK			199
RT0NPK			199
RT5NPK			200









SPECIAL NAILS

RS10GN			201
RS50GN			201
RZ1SNP			201
RZ0SNP			202
RZ00RN			202











ROOFING NAILS

RZ1SNB			203
RZ0SNB			203
RZ5SNB			203
RZ0SNE			204
RZ1SNE			204
RZ5SNE			204
RZ0STN			205
RZ5STN			205
RM0SKR			205
RM0SNE			205
RM5SNE			206
RZ0STN			205

PLASTERBOARD NAILS

RZ10PN			207
RZ1GYN			207
RZ0GYN			207
RZ5GYN			208

HOOKS & CLAWS

RZ10PD			209
RZ10BH			209
RZ00BH			209
RZ50BH			210
RZ0KLE			210

CRAMPS

RZ10KR			211
RZ00KR			211
RZ50KR			211

STANDAARD NAGELS
POINTES STANDARDS
STANDARD NAILS
STANDARDNÄGEL

RS1NPK



Nagel met ronde kop DIN 1151B
Pointe à tête plate DIN 1151B
Flat head construction nail DIN 1151B
Flachkopfstifte DIN 1151B

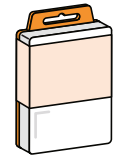

d [mm]	l [mm]	Art. ref.	EAN code			Price code	Packaging
1	15	RS1NPK010015	5410439321419	100 g	6	OB1	Blister B
1,2	20	RS1NPK012020	5410439323192	120 g	6	OB1	Blister B
1,5	25	RS1NPK015025	5410439323208	140 g	6	OB1	Blister B
1,8	30	RS1NPK018030	5410439323215	160 g	6	OB1	Blister B
2	35	RS1NPK020035	5410439323222	180 g	6	OB1	Blister B
2	40	RS1NPK020040	5410439360371	180 g	6	OB1	Blister B
2,2	45	RS1NPK022045	5410439373500	220 g	6	OB1	Blister B
2,7	50	RS1NPK027050	5410439634052	220 g	6	OB1	Blister B
2,7	55	RS1NPK027055	5410439373517	220 g	6	OB1	Blister B
2,7	60	RS1NPK027060	5410439633956	220 g	6	OB1	Blister B
3	65	RS1NPK030065	5410439633963	220 g	6	OB1	Blister B
3,5	70	RS1NPK035070	5410439642781	220 g	6	OB1	Blister B
3,5	80	RS1NPK035080	5410439633970	220 g	3	OB1	Blister E
4	90	RS1NPK040090	5410439633987	220 g	3	OB1	Blister E
4	100	RS1NPK045100	5410439633994	220 g	3	OB1	Blister E
5	110	RS1NPK050110	5410439634007	220 g	3	OB1	Blister E
5	125	RS1NPK050120	5410439634014	220 g	3	OB1	Blister E
5	140	RS1NPK050140	5410439634021	500 g	1	OH1	Blister G
5,5	150	RS1NPK055150	5410439642798	500 g	1	OH1	Blister G
6	160	RS1NPK060160	5410439642804	600 g	1	OH1	Blister G
6,5	180	RS1NPK065180	5410439642934	500 g	1	OH1	Blister G
7	200	RS1NPK070200	5410439642941	500 g	1	OH1	Blister G

RS0NPK



Nagel met ronde kop DIN 1151B
Pointe à tête plate DIN 1151B
Flat head construction nail DIN 1151B
Flachkopfstifte DIN 1151B

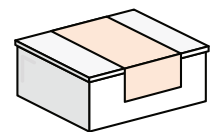

d [mm]	l [mm]	Art. ref.	EAN code			Price code	Packaging
1	15	RS0NPK010015	5410439641449	300 g	3	OH1	Box 2A





RS0NPK

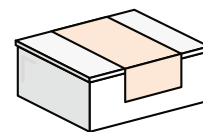

Nagel met ronde kop DIN 1151B
 Pointe à tête plate DIN 1151B
 Flat head construction nail DIN 1151B
 Flachkopfstifte DIN 1151B





d [mm]	l [mm]	Art. ref.	EAN code			Price code	Packaging
1,2	20	RS0NPK012020	5410439634069	400 g	3	OH1	Box 2A
1,5	25	RS0NPK015025	5410439634076	425 g	3	OH1	Box 2A
1,8	30	RS0NPK018030	5410439634083	470 g	1	OH1	Box 3A
2	35	RS0NPK020035	5410439641456	550 g	1	OH1	Box 3A
2	40	RS0NPK020040	5410439641500	600 g	1	OH1	Box 4A
2,2	45	RS0NPK022045	5410439642590	650 g	1	OH1	Box 4A
2,7	50	RS0NPK027050	5410439634090	700 g	1	OH1	Box 4A
2,7	55	RS0NPK027055	5410439642606	725 g	1	OH1	Box 4A
2,7	60	RS0NPK027060	5410439642613	725 g	1	OH1	Box 4A
3	65	RS0NPK030065	5410439634106	750 g	1	OH1	Box 4A
3,5	70	RS0NPK035070	5410439642620	750 g	1	OH1	Box 4A
3,5	80	RS0NPK035080	5410439634113	750 g	1	GH1	Box 4A
4	90	RS0NPK040090	5410439642637	750 g	1	OH1	Box 4A
4	100	RS0NPK045100	5410439634120	750 g	1	OH1	Box 4A
5	110	RS0NPK050110	5410439642644	750 g	1	OH1	Box 4A
5	125	RS0NPK050120	5410439634229	750 g	1	OH1	Box 4A
5,5	140	RS0NPK055140	5410439642651	1000 g	1	OI1	Box 6B
5,5	150	RS0NPK055150	5410439642668	1000 g	1	OI1	Box 6B
6	160	RS0NPK060160	5410439642675	1000 g	1	OI1	Box 6B
6,5	180	RS0NPK065180	5410439642682	1000 g	1	OI1	Box 6B
7	200	RS0NPK070200	5410439642699	1000 g	1	OI1	Box 6B

RZ0NPK

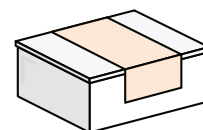

Nagel voor klemmen
 Pointe pour chrochets
 Nail for clamps
 Drahtstifte rund Senkkopf



d [mm]	l [mm]	Art. ref.	EAN code			Price code	Packaging
1,8	20	RZ0NPK018020	5410439644181	200 g	3	OA1	Box 1A

RS1SZK



Stiften zonder kop
Pointe sans tête
Nail without head
Goldleistenstifte



d [mm]	l [mm]	Art. ref.	EAN code			Price code	Packaging
9	32	RS1SZK009032	5410439634465	100 g	12	OH1	Blister A

RZ0NRK



Nagel met ronde kop DIN 1152
Pointe à tête ronde DIN 1152
Finishing nail DIN 1152
Stauchkopfstifte rund DIN 1152

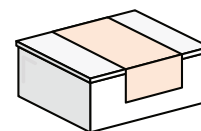

d [mm]	l [mm]	Art. ref.	EAN code			Price code	Packaging
1	15	RZ0NRK010015	5410439643023	300 g	3	OK1	Box 2A
1,2	20	RZ0NRK012020	5410439643030	400 g	3	OK1	Box 2A
1,5	25	RZ0NRK015025	5410439643047	425 g	3	OK1	Box 2A
1,8	30	RZ0NRK018030	5410439643054	470 g	3	OK1	Box 2A
2	35	RZ0NRK020035	5410439643061	550 g	1	OK1	Box 3A
2	40	RZ0NRK020040	5410439643115	600 g	1	OK1	Box 3A
2,2	45	RZ0NRK022045	5410439643122	650 g	1	OK1	Box 3A
2,7	50	RZ0NRK027050	5410439643573	700 g	1	OK1	Box 3A
2,7	55	RZ0NRK027055	5410439643580	725 g	1	OL1	Box 3A
2,7	60	RZ0NRK027060	5410439643627	725 g	1	OL1	Box 3A

RS1NRK



Nagel met ronde kop DIN 1152
Pointe à tête ronde DIN 1152
Finishing nail DIN 1152
Stauchkopfstifte rund DIN 1152



d [mm]	l [mm]	Art. ref.	EAN code			Price code	Packaging
1	15	RS1NRK010015	5410439634236	100 g	6	OB1	Blister B
1,2	20	RS1NRK012020	5410439634243	120 g	6	OB1	Blister B
1,5	25	RS1NRK015025	5410439634250	140 g	6	OB1	Blister B
1,8	30	RS1NRK018030	5410439634267	160 g	6	OB1	Blister B
2	35	RS1NRK020035	5410439634274	180 g	6	OB1	Blister B
2	40	RS1NRK020040	5410439634281	180 g	6	OB1	Blister B
2,2	45	RS1NRK022045	5410439634298	200 g	6	OB1	Blister B
2,7	50	RS1NRK027050	5410439634304	220 g	6	OB1	Blister B
2,7	55	RS1NRK027055	5410439634311	220 g	6	OB1	Blister B





RS1NRK



Nagel met ronde kop DIN 1152
 Pointe à tête ronde DIN 1152
 Finishing nail DIN 1152
 Stauchkopfstifte rund DIN 1152





d [mm]	l [mm]	Art. ref.	EAN code			Price code	Packaging
2,7	60	RS1NRK027060	5410439634328	220 g	6	OB1	Blister B
3	65	RS1NRK030065	5410439634335	220 g	6	OB1	Blister B
3,5	70	RS1NRK035070	5410439642965	220 g	6	OB1	Blister B
3,5	80	RS1NRK035080	5410439634434	220 g	3	OB1	Blister E
4	90	RS1NRK040090	5410439642989	220 g	3	OB1	Blister E
4	100	RS1NRK045100	5410439642996	220 g	3	OB1	Blister E
5	110	RS1NRK050110	5410439643009	220 g	3	OB1	Blister E
5	125	RS1NRK050120	5410439643016	220 g	3	OB1	Blister E

RS0NRK

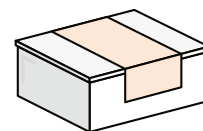

Nagel met ronde kop DIN 1152
 Pointe à tête ronde DIN 1152
 Finishing nail DIN 1152
 Stauchkopfstifte rund DIN 1152



d [mm]	l [mm]	Art. ref.	EAN code			Price code	Packaging
1	15	RS0NRK010015	5410439641067	300 g	3	OH1	Box 2A
1,2	20	RS0NRK012020	5410439641074	400 g	3	OH1	Box 2A
1,5	25	RS0NRK015025	5410439634441	425 g	3	OH1	Box 2A
1,8	30	RS0NRK018030	5410439634458	470 g	1	OH1	Box 3A
2	35	RS0NRK020035	5410439641081	550 g	1	OH1	Box 3A
2	40	RS0NRK020040	5410439641098	600 g	1	OH1	Box 4A
2,2	45	RS0NRK022045	5410439641104	650 g	1	OH1	Box 4A
2,7	50	RS0NRK027050	5410439641111	700 g	1	OH1	Box 4A
2,7	55	RS0NRK027055	5410439641166	725 g	1	OH1	Box 4A
2,7	60	RS0NRK027060	5410439641173	725 g	1	OH1	Box 4A
3	65	RS0NRK030065	5410439641180	750 g	1	OH1	Box 4A
3,5	70	RS0NRK035070	5410439641227	750 g	1	OH1	Box 4A
3,5	80	RS0NRK035080	5410439641258	750 g	1	OH1	Box 4A
4	90	RS0NRK040090	5410439641333	750 g	1	OH1	Box 4A
4	100	RS0NRK045100	5410439641340	750 g	1	OH1	Box 4A
5	110	RS0NRK050110	5410439641357	750 g	1	OH1	Box 4A
5	125	RS0NRK050120	5410439641371	750 g	1	OH1	Box 4A
5	140	RS0NRK050140	5410439641388	1000 g	1	OI1	Box 6B
5,5	150	RS0NRK055150	5410439641401	1000 g	1	OI1	Box 6B





RM1NBK

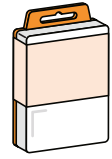

Nagel met bolkop
 Pointe à tête ronde
 Finishing nail
 Halbrundkopf Nägel



d [mm]	l [mm]	Art. ref.	EAN code			Price code	Packaging
1,5	15	RM1NBK015015	5410439643306	30 g	12	OD1	Blister A
1,5	20	RM1NBK015020	5410439643313	30 g	12	OD1	Blister A
1,8	25	RM1NBK018025	5410439643320	30 g	12	OD1	Blister A
1,8	30	RM1NBK018030	5410439643337	30 g	12	OD1	Blister A

GEHARDE NAGELS
POINTES DURCIS
HARDENED NAILS
ABGEHÄRTETE NÄGEL





RT1NKK



Nagel met bolle verzonken kop
Pointe à tête convexe
Masonry nail with convex head
Konvexkopfstifte



d [mm]	l [mm]	Art. ref.	EAN code			Price code	Packaging
2	20	RT1NKK020020	5410439643344	70 g	12	OC1	Blister A
2	25	RT1NKK020025	5410439634502	70 g	12	OC1	Blister A
2,4	30	RT1NKK024030	5410439634519	70 g	12	OC1	Blister A
3	40	RT1NKK030040	5410439634526	90 g	12	OC1	Blister A
3	50	RT1NKK030050	5410439634533	90 g	12	OC1	Blister A
3,5	60	RT1NKK035060	5410439634540	90 g	12	OC1	Blister A
3,5	70	RT1NKK035070	5410439634557	90 g	12	OC1	Blister A





RT0NKK

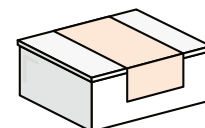

Nagel met bolle verzonken kop
Pointe à tête convexe
Masonry nail with convex head
Konvexkopfstifte



d [mm]	l [mm]	Art. ref.	EAN code			Price code	Packaging
2	20	RT0NKK020020	5410439646307	200 g	3	OH3	Box 1A
2	25	RT0NKK020025	5410439646314	200 g	3	OH3	Box 1A
2,4	30	RT0NKK024030	5410439646321	200 g	3	OH3	Box 1A
3	40	RT0NKK030040	5410439646345	250 g	3	OH3	Box 1A
3	50	RT0NKK030050	5410439646369	275 g	3	OH3	Box 1A
3,5	60	RT0NKK035060	5410439646475	275 g	3	OH3	Box 1A
3,5	70	RT0NKK035070	5410439646482	275 g	3	OH3	Box 2A
3,5	80	RT0NKK035080	5410439646499	275 g	3	OH3	Box 1A



RT5NKK



Nagel met bolle verzonken kop
 Pointe à tête convexe
 Masonry nail with convex head
 Konvexkopfstifte

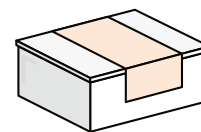

d [mm]	l [mm]	Art. ref.	EAN code			Price code	Packaging
2	20	RT5NKK020020	5410439646505	700 g	1	OS1	Box 4A
2	25	RT5NKK020025	5410439646512	800 g	1	OS1	Box 4A
2,4	30	RT5NKK024030	5410439646529	850 g	1	OS1	Box 4A
3	40	RT5NKK030040	5410439646536	900 g	1	OS1	Box 4A
3	50	RT5NKK030050	5410439646543	900 g	1	OS1	Box 4A
3,5	60	RT5NKK035060	5410439646550	900 g	1	OS1	Box 4A
3,5	70	RT5NKK035070	5410439646567	900 g	1	OS1	Box 4A
3,5	80	RT5NKK035080	5410439646574	900 g	1	OS1	Box 4A

RT1NPK



Nagel met bolle verzonken kop
 Pointe à tête fraisée plate
 Masonry nail with flat countersunk head
 Senkkopfstifte

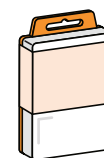

d [mm]	l [mm]	Art. ref.	EAN code			Price code	Packaging
2	20	RT1NPK020020	5410439643351	70 g	12	OC1	Blister A
2	25	RT1NPK020025	5410439634564	70 g	12	OC1	Blister A
2,4	30	RT1NPK024030	5410439634571	70 g	12	OC1	Blister A
3	40	RT1NPK030040	5410439634588	90 g	12	OC1	Blister A
3	50	RT1NPK030050	5410439634663	90 g	12	OC1	Blister A
3,5	60	RT1NPK035060	5410439634670	90 g	12	OC1	Blister A
3,5	70	RT1NPK035070	5410439634687	90 g	12	OC1	Blister A

RT0NPK



Nagel met bolle verzonken kop
 Pointe à tête fraisée plate
 Masonry nail with flat countersunk head
 Senkkopfstifte

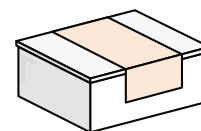

d [mm]	l [mm]	Art. ref.	EAN code			Price code	Packaging
2	20	RT0NPK020020	5410439643702	200 g	3	OH3	Box 1A
2	25	RT0NPK020025	5410439643719	200 g	3	OH3	Box 1A
2,4	30	RT0NPK024030	5410439643726	200 g	3	OH3	Box 1A
3	40	RT0NPK030040	5410439643733	250 g	3	OH3	Box 2A
3	50	RT0NPK030050	5410439643740	275 g	3	OH3	Box 2A





RT0NPK

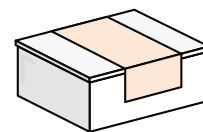

Nagel met bolle verzonken kop
 Pointe à tête fraisée plate
 Masonry nail with flat countersunk head
 Senkkopfstifte





d [mm]	l [mm]	Art. ref.	EAN code			Price code	Packaging
3,5	60	RT0NPK035060	5410439643795	275 g	3	OH3	Box 1A
3,5	70	RT0NPK035070	5410439646208	275 g	3	OH3	Box 1A
3,5	80	RT0NPK035080	5410439646215	275 g	3	OH3	Box 2A

RT5NPK

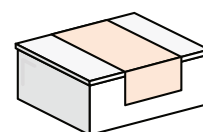

Nagel met bolle verzonken kop
 Pointe à tête fraisée plate
 Masonry nail with flat countersunk head
 Senkkopfstifte



d [mm]	l [mm]	Art. ref.	EAN code			Price code	Packaging
2	20	RT5NPK020020	5410439646222	700 g	1	OS1	Box 4A
2	25	RT5NPK020025	5410439646239	800 g	1	OS1	Box 4A
2,4	30	RT5NPK024030	5410439646246	850 g	1	OS1	Box 4A
3	40	RT5NPK030040	5410439646253	900 g	1	OS1	Box 4A
3	50	RT5NPK030050	5410439646260	900 g	1	OS1	Box 4A
3,5	60	RT5NPK035060	5410439646277	900 g	1	OS1	Box 4A
3,5	70	RT5NPK035070	5410439646284	900 g	1	OS1	Box 4A
3,5	80	RT5NPK035080	5410439646291	900 g	1	OS1	Box 4A

SPECIALE NAGELS
POINTES SPÉCIAUX
SPECIAL NAILS
SPEZIALNÄGEL

RS10GN



Getorste nagel
Pointe torsadée
Screw nail
Schraubenägel

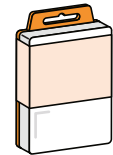

d [mm]	l [mm]	Art. ref.	EAN code			Price code	Packaging
3	50	RS10GN030050	5410439634472	125 g	6	OB1	Blister B
3	60	RS10GN030060	5410439634489	125 g	6	OB1	Blister B
3,5	65	RS10GN030070	5410439651684	125 g	6	OB1	Blister B
3,5	80	RS10GN030080	5410439634496	125 g	3	OB1	Blister E

RS50GN



Getorste nagel
Pointe torsadée
Screw nail
Schraubenägel

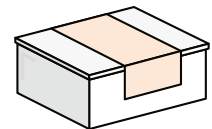

d [mm]	l [mm]	Art. ref.	EAN code			Price code	Packaging
3	50	RS50GN030050	5410439644044	1000 g	1	OO1	Box 5A
3	60	RS50GN030060	5410439644051	1000 g	1	OO1	Box 5A
3,5	65	RS50GN030070	5410439644068	1000 g	1	OO1	Box 5A
3,5	80	RS50GN030080	5410439644075	1000 g	1	OO1	Box 4A

RZ1SNP



Schroefnagel
Pointe torsadée
Screw nail
Schraubenägel

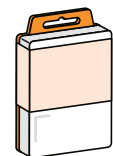

d [mm]	l [mm]	Art. ref.	EAN code			Price code	Packaging
3,8	32	RZ1SNP038032	5410439639040	20	12	OB1	Blister A
3,8	40	RZ1SNP038040	5410439639064	15	12	OB1	Blister A
3,8	50	RZ1SNP038050	5410439639071	11	12	OB1	Blister A
3,8	60	RZ1SNP038060	5410439639088	10	12	OB1	Blister A





RZ0SNP

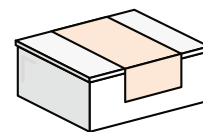

Schroefnagel
Pointe torsadée
Screw nail
Schraubenägel





d [mm]	l [mm]	Art. ref.	EAN code			Price code	Packaging
3,8	32	RZ0SNP038032	5410439269780	85	3	OH1	Box 1A
3,8	40	RZ0SNP038040	5410439269797	60	3	OH1	Box 1A
3,8	50	RZ0SNP038050	5410439269803	50	3	OH1	Box 1A
3,8	60	RZ0SNP038060	5410439269810	40	3	OH1	Box 1A

RZ0ORN

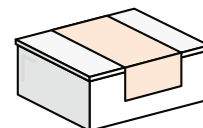

Ribnagel met cilindrische kop
Pointe striée à tête cylindrique
Ribbed masonry nail with cylinder head
Geriffelte Senkkopfstift



d [mm]	l [mm]	Art. ref.	EAN code			Price code	Packaging
3,5	35	RZ0ORN035035	5410439634915	250	1	OZ1	Box 3A
3,5	45	RZ0ORN035045	5410439634939	250	1	OZ1	Box 4A
3,5	55	RZ0ORN035055	5410439634946	250	1	OZ1	Box 4A
3,5	65	RZ0ORN035065	5410439268813	250	1	OZ1	Box 5A
4,5	80	RZ0ORN045080	5410439268820	200	1	OZ1	Box 5A

SCHALIENAGELS
POINTES D'ARDOISES
ROOFING NAILS
DACHNÄGEL

RZ1SNB



Schalienagel met brede kop DIN 1160A
Pointe d'ardoise tête large DIN 1160A
Roofing nail DIN 1160A
Schieferstifte DIN 1160A

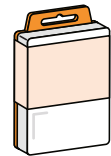

d [mm]	l [mm]	Art. ref.	EAN code			Price code	Packaging
2,7	30	RZ1SNB027030	5410439638586	100 g	6	OB1	Blister B
3	25	RZ1SNB030025	5410439638593	100 g	6	OB1	Blister B

RZ0SNB



Schalienagel met brede kop DIN 1160A
Pointe d'ardoise tête large DIN 1160A
Roofing nail DIN 1160A
Schieferstifte DIN 1160A

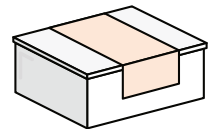

d [mm]	l [mm]	Art. ref.	EAN code			Price code	Packaging
2,7	30	RZ0SNB027030	5410439644167	270 g	3	OH1	Box 2A
3	25	RZ0SNB030025	5410439269827	270 g	3	OH1	Box 2A

RZ5SNB



Schalienagel met brede kop DIN 1160A
Pointe d'ardoise tête large DIN 1160A
Roofing nail DIN 1160A
Schieferstifte DIN 1160A

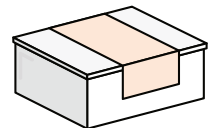

d [mm]	l [mm]	Art. ref.	EAN code			Price code	Packaging
2,7	30	RZ5SNB027030	5410439651745	1000 g	1	OL1	Box 5A
3	25	RZ5SNB030025	5410439651752	1000 g	1	OL1	Box 5A



RZ1SNE



Schalienagel met extra brede kop DIN 1160B
 Pointe d'ardoise tête extra large DIN 1160B
 Roofing nail DIN 1160B
 Schieferstifte DIN 1160B



d [mm]	l [mm]	Art. ref.	EAN code			Price code	Packaging
3	15	RZ1SNE030015	5410439484787	100 g	6	OC1	Blister B
3	20	RZ1SNE030020	5410439638609	100 g	6	OC1	Blister B
3	25	RZ1SNE030025	5410439638616	100 g	6	OC1	Blister B
3	40	RZ1SNE030040	5410439638623	100 g	6	OC1	Blister B



RZ0SNE



Schalienagel met extra brede kop DIN 1160B
 Pointe d'ardoise tête extra large DIN 1160B
 Roofing nail DIN 1160B
 Schieferstifte DIN 1160B

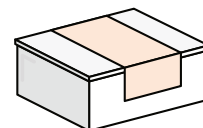

d [mm]	l [mm]	Art. ref.	EAN code			Price code	Packaging
3	15	RZ0SNE030015	5410439643368	270 g	3	OH1	Box 2A
3	20	RZ0SNE030020	5410439644143	270 g	3	OH1	Box 2A
3	25	RZ0SNE030025	5410439644150	270 g	3	OH1	Box 2A
3	40	RZ0SNE030040	5410439644174	270 g	3	OH1	Box 2A



RZ5SNE



Schalienagel met extra brede kop DIN 1160B
 Pointe d'ardoise tête extra large DIN 1160B
 Roofing nail DIN 1160B
 Schieferstifte DIN 1160B

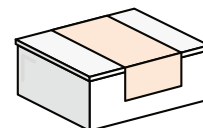

d [mm]	l [mm]	Art. ref.	EAN code			Price code	Packaging
3	15	RZ5SNE030015	5410439651769	1000 g	1	OL1	Box 4A
3	20	RZ5SNE030020	5410439638630	1000 g	1	OL1	Box 4A
3	25	RZ5SNE030025	5410439638661	1000 g	1	OL1	Box 5A
3	40	RZ5SNE030040	5410439638678	1000 g	1	OL1	Box 5A



RZ0STN



Stormnagel ronde kop
 Pointe à tête embase carrée
 Light board nail round
 Leichtbauplattenstift

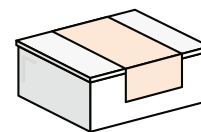

d [mm]	l [mm]	Art. ref.	EAN code			Price code	Packaging
3,5	50	RZ0STN031050	5410439269834	340 g	1	O11	Box 4A
3,1	60	RZ0STN031060	5410439269841	340 g	1	O11	Box 4A
3,5	70	RZ0STN031070	5410439269858	340 g	1	O11	Box 4A
3,4	80	RZ0STN031080	5410439269865	340 g	1	O11	Box 4A



RZ5STN



Stormnagel ronde kop
 Pointe à tête embase ronde
 Light board nail round
 Leichtbauplattenstift

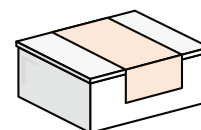

d [mm]	l [mm]	Art. ref.	EAN code			Price code	Packaging
3,5	50	RZ5STN031050	5410439644082	500 g	1	OL1	Box 4A
3,1	60	RZ5STN031060	5410439644099	500 g	1	OL1	Box 5A
3,5	70	RZ5STN031070	5410439644105	500 g	1	OL1	Box 5A
3,4	80	RZ5STN031080	5410439644112	500 g	1	OL1	Box 5A



RM0SKR



Stormkrammen
 Crampon tempête
 Disc rivets
 Sturmklammern Kopfer

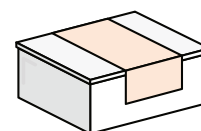

d [mm]	l [mm]	Art. ref.	EAN code			Price code	Packaging
2	20	RM0SKR020020	5410439646581	100	3	OQ1	Box 2A



RM0SNE



Schalienagel
 Pointe d'ardoise
 Roofing nail
 Schieferstifte DIN 1160B

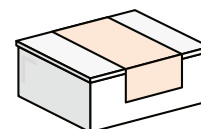

d [mm]	l [mm]	Art. ref.	EAN code			Price code	Packaging
2,5	30	RM0SNE025030	5410439642705	100	3	OM1	Box 1A
2,8	40	RM0SNE028040	5410439642712	100	3	OQ1	Box 1A



RM0SNE



Schalienagel
Pointe d'ardoise
Roofing nail
Schieferstifte DIN 1160B

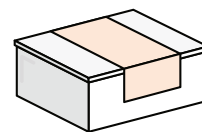

d [mm]	l [mm]	Art. ref.	EAN code			Price code	Packaging
3	50	RM0SNE030050	5410439642729	50	3	OS1	Box 2A





RM5SNE

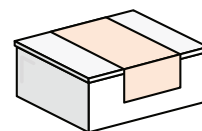

Schalienagel
Pointe d'ardoise
Roofing nail
Schieferstifte DIN 1160B



d [mm]	l [mm]	Art. ref.	EAN code			Price code	Packaging
2,5	27	RM5SNE025027	5410439642743	500 g	1	OZ1	Box 4A
2,5	30	RM5SNE025030	5410439642767	500 g	1	OZ1	Box 4A
2,8	40	RM5SNE028040	5410439642774	500 g	1	OZ1	Box 4A

GIPSPLAATNAGELS
POINTES POUR PANNEAUX DE PLATRE
PLASTERBOARD NAILS
GIPSPLATTENNÄGEL

RZ10PN



Plafonneernagel
 Pointe plafonneurs
 Ceiling nail
 Deckennägel

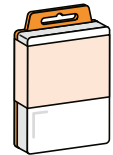

d [mm]	l [mm]	Art. ref.	EAN code			Price code	Packaging
2	25	RZ10PN020025	5410439639033	100 g	6	OB1	Blister B

RZ1GYN



Gipsplaatnagel
 Pointe panneaux de plâtre
 Plasterboard nail
 Gipsplattennägel

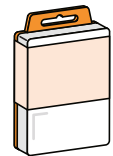

d [mm]	l [mm]	Art. ref.	EAN code			Price code	Packaging
2,2	32	RZ1GYN022032	5410439634694	100 g	6	OB1	Blister B
2,2	40	RZ1GYN022040	5410439634779	100 g	6	OB1	Blister B
2,2	50	RZ1GYN022050	5410439634786	100 g	6	OB1	Blister B
2,2	60	RZ1GYN022060	5410439634908	100 g	6	OB1	Blister B

RZ0GYN



Gipsplaatnagel
 Pointe panneaux de plâtre
 Plasterboard nail
 Gipsplattennägel

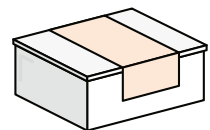

d [mm]	l [mm]	Art. ref.	EAN code			Price code	Packaging
2,2	32	RZ0GYN022032	5410439643634	300 g	3	OH1	Box 2A
2,2	40	RZ0GYN022040	5410439643641	300 g	3	OH1	Box 2A
2,2	50	RZ0GYN022050	5410439643658	300 g	3	OH1	Box 2A
2,2	60	RZ0GYN022060	5410439643665	300 g	3	OH1	Box 2A





RZ5GYN

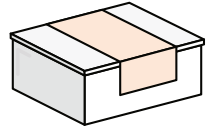

Gipsplaatnagel
 Pointe panneaux de plâtre
 Plasterboard nail
 Gipsplattennägel



d [mm]	l [mm]	Art. ref.	EAN code			Price code	Packaging
2,2	32	RZ5GYN022032	5410439643955	1000 g	1	YL1	Box 5A
2,2	40	RZ5GYN022040	5410439643962	1000 g	1	YL1	Box 5A
2,2	50	RZ5GYN022050	5410439643979	1000 g	1	YL1	Box 5A
2,2	60	RZ5GYN022060	5410439643986	1000 g	1	YL1	Box 5A

**HAKEN & KLEMMEN
CRAMPONS & CLIPS
HOOKS & CLAWS
HAKEN & KRALLEN**

RZ10PD



Puntduim
Gond à pointe
Square hook pin
Stifthaken

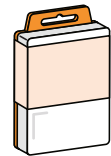

d [mm]	l [mm]	Art. ref.	EAN code			Price code	Packaging
2,4	20	RZ10PD025020	5410439638685	18	12	OB1	Blister A
2,4	25	RZ10PD025025	5410439651660	16	12	OD1	Blister A
3,2	30	RZ10PD030030	5410439638692	13	12	OD1	Blister A
3,2	40	RZ10PD040040	5410439638708	8	12	OB1	Blister A
4	50	RZ10PD040050	5410439651677	8	12	OB1	Blister A
4	60	RZ10PD040060	5410439638715	5	12	OC1	Blister A
5	80	RZ10PD050080	5410439638722	4	6	OB1	Blister B

RZ10BH



Balkhaak
Crampon solin
Square crooked nail
Viereckige Hakenstifte

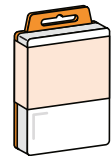

l [mm]	Art. ref.	EAN code			Price code	Packaging
40	RZ10BH050040	5410439642545	4	12	OB1	Blister A
50	RZ10BH050050	5410439642552	4	12	OB1	Blister A
60	RZ10BH050060	5410439642569	4	12	OB1	Blister A

RZ00BH



Balkhaak
Crampon solin
Square crooked nail
Viereckige Hakenstifte

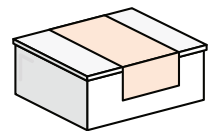

l [mm]	Art. ref.	EAN code			Price code	Packaging
40	RZ00BH050040	5410439642583	250 g	3	OH3	Box 2A
50	RZ00BH050050	5410439642736	250 g	3	OH3	Box 2A
60	RZ00BH050060	5410439642750	250 g	3	OH3	Box 2A





RZ50BH

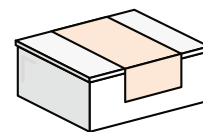

Balkhaak
Crampon solin
Square crooked nail
Viereckige Hakenstifte



l [mm]	Art. ref.	EAN code			Price code	Packaging
40	RZ50BH050040	5410439642958	1000 g	1	OS1	Box 4A
50	RZ50BH050050	5410439642972	1000 g	1	OS1	Box 4A
60	RZ50BH050060	5410439643139	1000 g	1	OS1	Box 4A





RZ0KLE

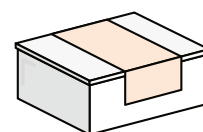

Klemmen met nagel
Clip pour landris avec pointe
Join claw with nail
Profilbrettkralle mit Nägel



d [mm]	Art. ref.	EAN code			Price code	Packaging
1	RZ0KLE010000	5410439269759	200	1	OM1	Box 4A
2	RZ0KLE020000	5410439644129	200	1	OL1	Box 5A
3	RZ0KLE030000	5410439644136	200	1	OL1	Box 5A
4	RZ0KLE040000	5410439269766	200	1	OL1	Box 5A
5	RZ0KLE050000	5410439269773	200	1	OL1	Box 5A

KRAMMEN
CRAMPONS
CRAMPS
KRAMPEN

RZ10KR



Krammen Type U
Crampon type U
Cramps type U
Krampen Typ U

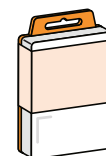

d [mm]	l [mm]	Art. ref.	EAN code			Price code	Packaging
1,8	15	RZ10KR018015	5410439634977	40 g	12	OB1	Blister A
2	20	RZ10KR020020	5410439634984	50 g	12	OB1	Blister A
2,7	25	RZ10KR027025	5410439635011	60 g	12	OB1	Blister A
3	30	RZ10KR030030	5410439635028	60 g	12	OB1	Blister A
3,5	35	RZ10KR035035	5410439638517	60 g	12	OB1	Blister A

RZ00KR



Krammen Type U
Crampon type U
Cramps type U
Krampen Typ U

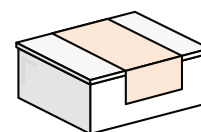

d [mm]	l [mm]	Art. ref.	EAN code			Price code	Packaging
1,8	15	RZ00KR018015	5410439651691	200 g	3	OH3	Box 1A
2	20	RZ00KR020020	5410439651707	260 g	3	OH1	Box 2A
2,7	25	RZ00KR027025	5410439651714	325 g	1	OH1	Box 4A
3	30	RZ00KR030030	5410439651721	350 g	1	OH1	Box 4A
3,5	35	RZ00KR035035	5410439651738	350 g	1	OH3	Box 4A

RZ50KR



Krammen Type U
Crampon type U
Cramps type U
Krampen Typ U

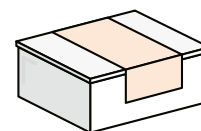

d [mm]	l [mm]	Art. ref.	EAN code			Price code	Packaging
1,8	15	RZ50KR018015	5410439638524	1000 g	1	OS1	Box 4A
2	20	RZ50KR020020	5410439638531	1000 g	1	OR1	Box 4A
2,7	25	RZ50KR027025	5410439638548	1000 g	1	OP1	Box 4A





RZ50KR

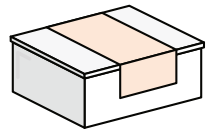

Krammen Type U
 Crampon type U
 Cramps type U
 Krampen Typ U































d [mm]	l [mm]	Art. ref.	EAN code			Price code	Packaging
3	30	RZ50KR030030	5410439638579	1000 g	1	001	Box 4A
3,5	35	RZ50KR035035	5410439643672	1000 g	1	001	Box 4A
4	40	RZ50KR040040	5410439643689	1000 g	1	001	Box 5A
4,5	45	RZ50KR045045	5410439643696	1000 g	1	001	Box 5A

















HAKEN & ÖGEN
CROCHETS & OEILLETES
HOOKS & EYES
HAKEN UND ÖSEN

HOOKS/EYES

YW10SO			217
YZ10SO			217
YZ00SO			218
YM10SO			218
YW10SD			218
YZ10SD			219
YZ1ZSD			219
YZ00SD			219
YM10SD			220
YW10SH			220
YZ10SH			220
YZ00SH			221
YM10SH			221
YZ10WH			221

NAILS

YM1NBK			222
YS10BN			222
YS00BN			222
YZ10PD			223
YZ00PD			223
YZ10BH			223
YT1VKH			224
YT0VKH			224
YT1SHV			224

MISCELLANEOUS

YM10DK			225
YN10SR			225
YZ1094			225
YZ1024			226
YM10BR			226
YK10PH			226
YM10KH			226
YM1XWH			227
YM1ZKH			227

YM1XWH			227
YM1SIN			228
YK10PP			228
YM1DSP			228
YK1MGN			228

HAKEN & OOGHAKEN
CROCHETS ET CROCHETS À ŒIL
HOOKS & EYHOOKS
HAKEN & ÖSENHAKEN

YW10SO



Schroefoog
Piton ordinaire
Screw eye
Schrauböse

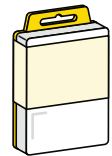

d [mm]	l [mm]	Art. ref.	EAN code			Price code	Packaging
2,4	10	YW10SO025010	5410439651523	9	12	YC1	Blister A
3,2	16	YW10SO030016	5410439639897	6	12	YC1	Blister A
3,45	20	YW10SO035020	5410439639903	4	12	YC1	Blister A
4	30	YW10SO040030	5410439639910	3	12	YC1	Blister A
4,4	40	YW10SO050040	5410439639927	3	12	YC1	Blister A

YZ10SO



Schroefoog
Piton ordinaire
Screw eye
Schrauböse

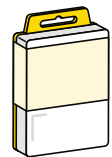

d [mm]	l [mm]	Art. ref.	EAN code			Price code	Packaging
2,65	12	YZ10SO027512	5410439651530	18	12	YB1	Blister A
2,65	16	YZ10SO030016	5410439639934	12	12	YB1	Blister A
3,2	20	YZ10SO030020	5410439651547	8	12	YB1	Blister A
4	25	YZ10SO040025	5410439639941	6	12	YB1	Blister A
4	30	YZ10SO040030	5410439651554	6	12	YC1	Blister A
4,4	40	YZ10SO045040	5410439639965	5	12	YC1	Blister A
5,25	60	YZ10SO052560	5410439639989	4	3	YD1	Blister E
7	60	YZ10SO070060	5410439640008	4	3	YJ1	Blister E
7	100	YZ10SO070100	5410439651561	4	1	YK1	Blister G
7	140	YZ10SO070140	5410439651578	4	1	YK1	Blister G



YZ00SO



Schroefoog
Piton ordinaire
Screw eye
Schrauböse

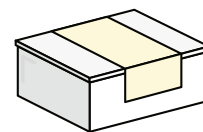

d [mm]	l [mm]	Art. ref.	EAN code			Price code	Packaging
2,15	12	YZ00SO027512	5410439640046	60	3	YH3	Box 1A
3,2	16	YZ00SO030016	5410439640053	40	3	YH3	Box 1A
3,2	20	YZ00SO030020	5410439640060	30	3	YH3	Box 1A
4	25	YZ00SO040025	5410439640084	24	3	YH3	Box 1A
4	30	YZ00SO040030	5410439640114	16	3	YH3	Box 1A
4,4	40	YZ00SO045040	5410439640152	10	3	YG1	Box 1A
5,25	60	YZ00SO052560	5410439640206	8	3	Y11	Box 1A

YM10SO



Schroefoog
Piton ordinaire
Screw eye
Schrauböse



d [mm]	l [mm]	Art. ref.	EAN code			Price code	Packaging
2,65	12	YM10SO022010	5410439651486	8	12	YF1	B blister A
2,5	12	YM10SO025012	5410439639873	5	12	YF1	B blister A
2,65	16	YM10SO027016	5410439651493	3	12	YF1	B blister A
3	20	YM10SO030020	5410439651509	3	12	YF1	B blister A
3,5	25	YM10SO035025	5410439639880	2	12	YF1	B blister A
4	30	YM10SO035030	5410439651516	2	12	YF1	B blister A

YW10SD



Schroefduim
Gond à vis
Square hook
Gerade Schraubhaken



d [mm]	l [mm]	Art. ref.	EAN code			Price code	Packaging
2,4	25	YW10SD025025	5410439639415	7	12	YC1	B blister A
3,2	30	YW10SD030030	5410439651400	6	12	YC1	B blister A
3,2	40	YW10SD030040	5410439639422	4	12	YC1	B blister A
3,45	50	YW10SD035050	5410439651417	3	12	YC1	B blister A
4	60	YW10SD040060	5410439639439	2	12	YC1	B blister A



YZ10SD



Schroefduim
Gond à vis
Square hook
Gerade Schraubhaken

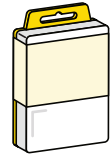

d [mm]	l [mm]	Art. ref.	EAN code			Price code	Packaging
2,15	20	YZ10SD022520	5410439639361	18	12	YC1	Blister A
2,4	25	YZ10SD025025	5410439639385	16	12	YC1	Blister A
3,2	30	YZ10SD030030	5410439639392	13	12	YC1	Blister A
3,2	40	YZ10SD030040	5410439639408	8	12	YC1	Blister A
3,45	50	YZ10SD035050	5410439646598	6	12	YC1	Blister A
4	60	YZ10SD040060	5410439646604	5	12	YC1	Blister A
4,4	80	YZ10SD045080	5410439646611	4	12	YC1	Blister A



YZ1ZSD



Schroefduim met gleuf
Gond à vis avec fente
Square hook with slot
Gerade Schraubhaken mit Schlitz

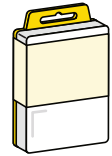

d [mm]	l [mm]	Art. ref.	EAN code			Price code	Packaging
5,25	40	YZ1ZSD050040	5410439651585	4	12	YC1	Blister A
5,25	50	YZ1ZSD050050	5410439640336	3	12	YC1	Blister A
6	65	YZ1ZSD060065	5410439640343	4	12	YD1	Blister A
6	80	YZ1ZSD060080	5410439640350	4	3	YG1	Blister E



YZ00SD



Schroefduim
Gond à vis
Square hook
Gerade Schraubhaken

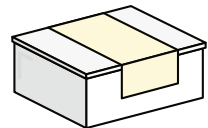

d [mm]	l [mm]	Art. ref.	EAN code			Price code	Packaging
2,15	20	YZ00SD022520	5410439639477	80	3	YH3	Box 1A
2,4	25	YZ00SD025025	5410439639491	70	3	YG1	Box 1A
3,2	30	YZ00SD030030	5410439639507	50	3	YH1	Box 1A
3,2	40	YZ00SD030040	5410439639514	27	3	YG1	Box 1A
3,45	50	YZ00SD035050	5410439639521	21	3	YG1	Box 1A
4	60	YZ00SD040060	5410439639538	14	3	YG1	Box 1A
4,4	80	YZ00SD045080	5410439639576	13	3	YG1	Box 1A





YM10SD



Schroefduim
Gond à vis
Square hook
Gerade Schraubhaken



d [mm]	l [mm]	Art. ref.	EAN code			Price code	Packaging
2,15	20	YM10SD025020	5410439639446	7	12	YF1	Blister A
2,5	25	YM10SD025025	5410439651424	6	12	YF1	Blister A
3	30	YM10SD030030	5410439639453	5	12	YF1	Blister A
3,5	40	YM10SD035040	5410439651431	3	12	YF1	Blister A





YW10SH



Schroefhaak
Crochet d'armoire
Cup hooks
Gebogene Schraubhaken



d [mm]	l [mm]	Art. ref.	EAN code			Price code	Packaging
2,15	10	YW10SH022510	5410439651479	9	12	YC1	Blister A
2,4	16	YW10SH025016	5410439639750	6	12	YC1	Blister A
3,2	20	YW10SH030020	5410439639767	4	12	YC1	Blister A
3,45	30	YW10SH035030	5410439639774	3	12	YC1	Blister A





YZ10SH



Schroefhaak
Crochet d'armoire
Cup hooks
Gebogene Schraubhaken



d [mm]	l [mm]	Art. ref.	EAN code			Price code	Packaging
2,4	12	YZ10SH024012	5410439651448	18	12	YD1	Blister A
2,4	16	YZ10SH025016	5410439639644	12	12	YC1	Blister A
3,2	20	YZ10SH030020	5410439639651	8	12	YC1	Blister A
3,45	30	YZ10SH035030	5410439651455	6	12	YC1	Blister A
4,4	30	YZ10SH045030	5410439639668	6	12	YC1	Blister A
4,5	50	YZ10SH045050	5410439639675	5	6	YC1	Blister B
5	50	YZ10SH050050	5410439639682	4	3	YD1	Blister E



YZ00SH



Schroefhaak
Crochet d'armoire
Cup hooks
Gebogene Schraubhaken

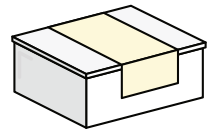

d [mm]	l [mm]	Art. ref.	EAN code			Price code	Packaging
2,4	12	YZ00SH024012	5410439639798	60	3	YG1	Box 1A
2,4	16	YZ00SH025016	5410439639804	40	3	YG1	Box 1A
3,2	20	YZ00SH030020	5410439639835	25	3	YG1	Box 1A
3,45	30	YZ00SH035030	5410439639842	21	3	YG1	Box 1A
4,4	30	YZ00SH045030	5410439639859	15	3	YG1	Box 1A
4,4	50	YZ00SH045050	5410439639866	10	3	YH3	Box 1A



YM10SH



Schroefhaak
Crochet d'armoire
Cup hooks
Gebogene Schraubhaken

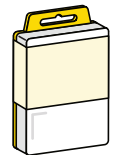

d [mm]	l [mm]	Art. ref.	EAN code			Price code	Packaging
2,25	10	YM10SH022010	5410439639705	7	12	YB1	Blister A
2,5	12	YM10SH025012	5410439651462	5	12	YE1	Blister A
3	16	YM10SH030016	5410439639729	3	12	YE1	Blister A
3	20	YM10SH030020	5410439639736	2	12	YE1	Blister A
3,5	30	YM10SH035030	5410439639743	2	12	YE1	Blister A



YZ10WH



Windhaak
Crochet contre vent
Gate hooks
Sturmhaken

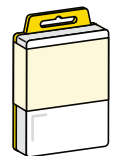

d [mm]	l [mm]	Art. ref.	EAN code			Price code	Packaging
3,5	50	YZ10WH035050	5410439640244	2	12	YE1	Blister A
3,5	60	YZ10WH035060	5410439640251	2	12	YE1	Blister A
4	80	YZ10WH040080	5410439640268	4	3	YH3	Blister E
4	100	YZ10WH040100	5410439640275	4	3	YH3	Blister E
4,5	120	YZ10WH045120	5410439640282	4	3	YI1	Blister E

NAGELS
POINTES
NAILS
NÄGEL



MS
Brass

YM1NBK



Nagel met bolkop
Pointe tête ronde
Finishing nail
Halbrundkopf Nägel



d [mm]	l [mm]	Art. ref.	EAN code			Price code	Packaging
1,5	15	YM1NBK015015	5410439639316	30 g	12	YD1	Blister A
1,5	20	YM1NBK015020	5410439639323	30 g	12	YD1	Blister A
1,8	25	YM1NBK018025	5410439639347	30 g	12	YD1	Blister A
1,8	30	YM1NBK018030	5410439639354	30 g	12	YD1	Blister A



SS
Hardened steel

YS10BN



Bloknagel
Semence hors tête
Tack
Tack



d [mm]	l [mm]	Art. ref.	EAN code			Price code	Packaging
8	10	YS10BN080010	5410439640299	30 g	12	YA1	Blister A
12	12	YS10BN120012	5410439640305	30 g	12	YA1	Blister A
14	14	YS10BN140014	5410439640312	30 g	12	YA1	Blister A



SS
Hardened steel

YS00BN

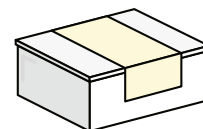

Bloknagel
Semence hors tête
Tack
Tack



d [mm]	l [mm]	Art. ref.	EAN code			Price code	Packaging
8	10	YS00BN080010	5410439269919	150 g	3	YH1	Box 1A
12	12	YS00BN120012	5410439565127	160 g	3	YH1	Box 1A
14	14	YS00BN140014	5410439644037	160 g	3	YH1	Box 1A



YZ10PD



Puntduim
Gonds à pointes
Square hook pin
Stifthaken

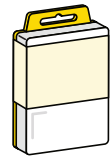

d [mm]	l [mm]	Art. ref.	EAN code			Price code	Packaging
2,50	20	YZ10PD025020	5410439643153	18	12	YB1	Blister A
2,50	25	YZ10PD025025	5410439643160	16	12	YD1	Blister A
3,0	30	YZ10PD030030	5410439643177	13	12	YD1	Blister A
3,5	40	YZ10PD040040	5410439643184	8	12	YB1	Blister A
4,00	50	YZ10PD040050	5410439643191	8	12	YB1	Blister A
4,00	60	YZ10PD040060	5410439643207	5	12	YC1	Blister A
5,00	80	YZ10PD050080	5410439643214	4	6	YB1	Blister B



YZ00PD



Puntduim
Gonds à pointes
Square hook pin
Stifthaken

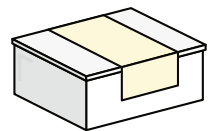

d [mm]	l [mm]	Art. ref.	EAN code			Price code	Packaging
2,50	20	YZ00PD022520	5410439643221	80	3	YH3	Box 1A
2,50	25	YZ00PD025025	5410439643238	70	3	YG1	Box 1A
3,0	30	YZ00PD030030	5410439643245	50	3	YH1	Box 1A
3,5	40	YZ00PD030040	5410439643252	27	3	YG1	Box 1A
4,00	50	YZ00PD035050	5410439643269	21	3	YG1	Box 1A
4,00	60	YZ00PD040060	5410439643276	14	3	YG1	Box 1A
5,00	80	YZ00PD050080	5410439643290	11	3	YG1	Box 1A



YZ10BH



Balkhaak
Crampon solin
Square crooked nail
Viereckige Hakenstifte

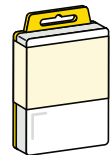

d [mm]	Art. ref.	EAN code			Price code	Packaging
40	YZ10BH050040	5410439640213	4	12	YB1	Blister A
50	YZ10BH050050	5410439640220	4	12	YB1	Blister A
60	YZ10BH050060	5410439640237	4	12	YB1	Blister A





YT1VKH



Vierkante konsolhaak
Crochet carré
Steel hook
Konsolhaken



d [mm]	Art. ref.	EAN code			Price code	Packaging
40	YT1VKH025040	5410439565110	22	12	YE1	Blister A
50	YT1VKH040050	5410439640404	14	12	YE1	Blister A
60	YT1VKH040060	5410439640428	10	12	YE1	Blister A
70	YT1VKH040070	5410439640442	8	12	YE1	Blister A





YT0VKH

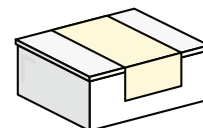

Vierkante konsolhaak
Crochet carré
Steel hook
Konsolhaken



d [mm]	Art. ref.	EAN code			Price code	Packaging
40	YT0VKH000040	5410439800204	70	3	YJ1	Box 1A
50	YT0VKH000050	5410439800211	40	3	YJ1	Box 1A
60	YT0VKH000060	5410439800228	30	3	YJ1	Box 1A
70	YT0VKH000070	5410439800235	20	3	YJ1	Box 1A





YT1SHV



Gebel. stalen haak V-vorm
Crochet forme-V
Wall hook
Stahlwandhaken



d [mm]	Art. ref.	EAN code			Price code	Packaging
40	YT1SHV000400	5410439640367	9	12	YE1	Blister A
50	YT1SHV000500	5410439640374	7	12	YE1	Blister A
60	YT1SHV000600	5410439640381	6	12	YE1	Blister A
70	YT1SHV000700	5410439269926	5	12	YE1	Blister A

VARIA
DIVERS
MISCELLANEOUS
DIVERSES

YM10DK



Drukknop
Bouton-pression
Buttons
Druckknöpfe

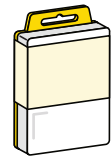

d [mm]	Art. ref.	EAN code			Price code	Packaging
15	YM10DK150000	5410439651592	4	12	YH1	Blister A

YN10SR



Schoenring
Oeillet pour chaussures
Eyelet for shoes
Öse für Schuhe

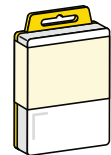

d [mm]	Art. ref.	EAN code			Price code	Packaging
4	YN10SR040000	5410439643894	30	12	YB1	Blister A
5	YN10SR050000	5410439643900	25	12	YB1	Blister A
6	YN10SR060000	5410439643917	20	12	YB1	Blister A

YZ1094



Splitpen DIN 94
Goupille fendue DIN 94
Split pins DIN 94
Splinte DIN 94

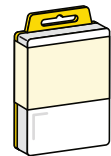

d [mm]	l [mm]	Art. ref.	EAN code			Price code	Packaging
1,6	20	YZ1094016020	5410439643832	25	12	YB1	Blister A
2	25	YZ1094020025	5410439643849	17	12	YB1	Blister A
2,5	32	YZ1094025032	5410439643856	12	12	YB1	Blister A
3,2	40	YZ1094032040	5410439643863	14	12	YC1	Blister A
4	50	YZ1094040050	5410439643870	10	12	YC1	Blister A
5	63	YZ1094050063	5410439643887	6	12	YC1	Blister A



YZ1024



Verende borgclip
Goupille
Spring pin standard
Standard-Federstecker doppel



d [mm]	l [mm]	Art. ref.	EAN code			Price code	Packaging
2	50	YZ1024020050	5410439643924	4	12	YC1	Blister A
3	60	YZ1024030060	5410439643931	3	12	YC1	Blister A
4	80	YZ1024040080	5410439643948	3	3	YD1	Blister E



YM10BR



Buisrivet
Rivet tubulaire
Tubular rivets
HohlNieten



d [mm]	Art. ref.	EAN code			Price code	Packaging
7	YM10BR070000	5410439651608	7	12	YB1	Blister A
9	YM10BR090000	5410439651615	6	12	YB1	Blister A
10	YM10BR100000	5410439651622	4	12	YB1	Blister A
12	YM10BR120000	5410439651639	3	12	YB1	Blister A



YK10PH



Ophanghaakje type L
Crochet type L
Wall picture hook type L
Bilderhaken Typ L



d [mm]	Art. ref.	EAN code			Price code	Packaging
30 mm	YK10PH020000	5410439651646	6	12	YE1	Blister A
40 mm	YK10PH030000	5410439651653	4	6	YE1	Blister B



YM10KH



Kaderhechtingen
Attaches cadres
Wall hooks
Bilderklappösen Eisen



d [mm]	Art. ref.	EAN code			Price code	Packaging
11	YM10KH110000	5410439639224	10	12	YB1	Blister A
13	YM10KH130000	5410439639231	9	12	YB1	Blister A



YM10KH



Kaderhechtingen
 Attaches cadres
 Wall hooks
 Bilderklappösen Eisen

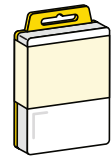

d [mm]	Art. ref.	EAN code			Price code	Packaging
16	YM10KH160000	5410439639279	7	12	YB1	Blister A



YM1XWH



X-Wandhaak voor kaders
 Crochets X pour cadres
 Wall hook & pin
 Bilderhaken,Eisen

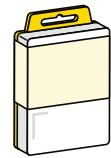

d [mm]	Art. ref.	EAN code			Price code	Packaging
21	YM1XWH010000	5410439639170	14	12	YB1	Blister A
29	YM1XWH020000	5410439639194	12	12	YB1	Blister A
30	YM1XWH030000	5410439639200	6	12	YB1	Blister A
33	YM1XWH040000	5410439639217	4	6	YB1	Blister B



YM1XWH NAILS



Vermessingde nagel voor X-wandhaak
 Pointe acier pour crochets X
 Pin for wall hook
 Stahlnägel

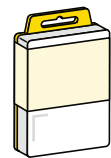

d [mm]	l [mm]	Art. ref.	EAN code			Price code	Packaging
1,4	26	YM1XWH014026	5410439639187	40	12	YB1	Blister A



YM1ZKH



Kleefbare kaderhaakjes
 Attache cadres collant
 Adhesive wall hooks
 Klebende Bilderklappöse

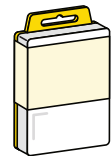

d [mm]	Art. ref.	EAN code			Price code	Packaging
30	YM1ZKH000030	5410439639309	10	12	YE1	Blister A



YM1SIN



Siernagel
Clous de garnissage
Decoration nail
Polsternägel



d [mm]	Art. ref.	EAN code			Price code	Packaging
1	YM1SIN010000	5410439639149	24	12	YB1	Blister A
1	YM1SIN020000	5410439639156	24	12	YB1	Blister A
1	YM1SIN030000	5410439639163	16	12	YB1	Blister A

YK10PP



Prikpin
punaise
Push pin
Pinwandstifte



d [mm]	Art. ref.	EAN code	Colour			Price code	Packaging
1	YK10PP000000	5410439639095		24	12	YB1	Blister A

YM1DSP



Duimspijkers Koper
Punaises cuivre
Drawing pin Brassed
Reißnägel vermessingt



d [mm]	Art. ref.	EAN code	Colour			Price code	Packaging
1	YM1DSP010000	5410439639118		80	12	YB1	Blister A
1	YM1DSP020000	5410439639125		40	12	YB1	Blister A
1	YM1DSP030000	5410439639132		40	12	YB1	Blister A

YK1MGN



White-board magneet
Aimant tableau blanc
White board magnet
Whiteboard-Magnet







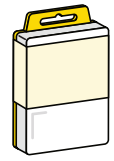

d [mm]	Art. ref.	EAN code	Colour			Price code	Packaging
30	YK1MGN30BLAU	5410439273466		6	6	YH1	Blister B
30	YK1MGN30GEEL	5410439273473		6	6	YH1	Blister B
30	YK1MGN30GROE	5410439273480		6	6	YH1	Blister B
30	YK1MGN30ROOD	5410439273497		6	6	YH1	Blister B

YK1MGN



White-board magneet
 Aimant tableau blanc
 White board magnet
 Whiteboard-Magnet



d [mm]	Art. ref.	EAN code	Colour			Price code	Packaging
30	YK1MGN30WIT	5410439273503		6	6	YH1	Blister B
30	YK1MGN30ZWAR	5410439273510		6	6	YH1	Blister B
30	YK1MGNASS6KL	5410439272896		6	6	YH1	Blister B

HAIPAX®

4 x 35
50



T 20
BlueTop
Coating

HZ2VTV040035











5 410439 076456





HAPAX HOUTSCHROEVEN
VIS À BOIS HAPAX
HAPAX WOOD SCREWS
HAPAX HOLZSCHRAUBEN

HAPAX SCREWS

HZ2VTV			233
HZ2VTG			233
HZ2VTG_8			235
HZ2TTG			235

HZ2VTV





Hapax hout Schroef met voldraad en verzonken kop

Vis à bois Hapax à filetage intégral et tête fraisée

Hapax wood screw with full thread and countersunk head

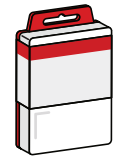
Hapax-Holzschraube mit Vollgewinde und Senkkopf



d [mm]	l [mm]	Art. ref.	EAN code			Price code	Packaging
4	16	HZ2VTV035016	5410439066129	100	6	HH1	Blister B
4	20	HZ2VTV035020	5410439076500	100	6	HH1	Blister B
4	30	HZ2VTV035030	5410439076494	100	6	HH2	Blister B
4	40	HZ2VTV035040	5410439077156	50	6	HG1	Blister B
4	50	HZ2VTV035050	5410439077163	50	6	HG1	Blister B
4	16	HZ2VTV040016	5410439078924	50	6	HF1	Blister B
4	20	HZ2VTV040020	5410439076487	50	6	HF1	Blister B
4	25	HZ2VTV040025	5410439076470	50	6	HG1	Blister B
4	30	HZ2VTV040030	5410439076463	50	6	HG1	Blister B
4	35	HZ2VTV040035	5410439076456	50	6	HG1	Blister B
5	30	HZ2VTV045030	5410439076449	50	6	HG1	Blister B
5	35	HZ2VTV045035	5410439076432	50	6	HH1	Blister B
5	20	HZ2VTV050020	5410439078993	40	6	HG1	Blister B
5	25	HZ2VTV050025	5410439076425	40	6	HG1	Blister B
5	30	HZ2VTV050030	5410439076418	40	6	HG1	Blister B
5	35	HZ2VTV050035	5410439076401	40	6	HH1	Blister B
6	40	HZ2VTV060040	5410439076395	20	6	HG1	Blister B
6	45	HZ2VTV060045	5410439076388	20	6	HG1	Blister B
6	50	HZ1VTV060050	5410439078665	10	6	HD1	Blister B
6	50	HZ2VTV060050	5410439076371	20	6	HG1	Blister B
6	60	HZ2VTV060060	5410439079075	20	6	HH2	Blister B

HZ2VTG





Hapax hout Schroef met deeldraad en verzonken kop

Vis à bois Hapax à filetage fendu et tête fraisée

Hapax wood screw with partial thread and countersunk head

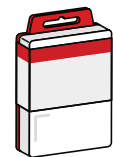
Hapax-Holzschraube mit geteiltem Gewinde und Senkkopf



d [mm]	l [mm]	Art. ref.	EAN code			Price code	Packaging
4	40	HZ2VTG035040	5410439076791	50	6	HG1	Blister B
4	50	HZ2VTG035050	5410439076784	50	6	HG1	Blister B
4	40	HZ1VTG040040	5410439080859	25	6	HE1	Blister B
4	40	HZ2VTG040040	5410439076777	50	6	HG1	Blister B
4	45	HZ2VTG040045	5410439076760	50	6	HH1	Blister B
4	50	HZ2VTG040050	5410439076753	50	6	HH1	Blister B
4	60	HZ2VTG040060	5410439076746	50	6	HH2	Blister B
4	70	HZ2VTG040070	5410439077118	40	6	HH2	Blister B
5	40	HZ2VTG045040	5410439076739	50	6	HH1	Blister B

HZ2VTG



Hapax hout Schroef met deeldraad en verzonken kop

Vis à bois Hapax à filetage fendu et tête fraisée

Hapax wood screw with partial thread and countersunk head

Hapax-Holzschraube mit geteiltem Gewinde und Senkkopf



d [mm]	l [mm]	Art. ref.	EAN code			Price code	Packaging
5	45	HZ2VTG045045	5410439078795	40	6	HH1	Blister B
5	50	HZ2VTG045050	5410439076722	40	6	HH1	Blister B
5	60	HZ2VTG045060	5410439076715	40	6	HH2	Blister B
5	70	HZ2VTG045070	5410439076708	40	3	HK1	Blister E
5	80	HZ2VTG045080	5410439076692	40	3	HK1	Blister E
5	40	HZ2VTG050040	5410439076685	40	6	HH1	Blister B
5	45	HZ2VTG050045	5410439076678	40	6	HH1	Blister B
5	50	HZ1VTG050050	5410439078610	15	6	HD1	Blister B
5	50	HZ2VTG050050	5410439076661	30	6	HH1	Blister B
5	60	HZ1VTG050060	5410439078634	15	6	HD1	Blister B
5	60	HZ2VTG050060	5410439076654	30	6	HH1	Blister B
5	70	HZ2VTG050070	5410439076647	30	3	HJ1	Blister E
5	80	HZ2VTG050080	5410439066150	30	3	HK1	Blister E
5	90	HZ2VTG050090	5410439076630	30	3	HK1	Blister E
5	100	HZ2VTG050100	5410439076623	30	3	HL1	Blister E
5	120	HZ2VTG050120	5410439076616	30	3	HN1	Blister E
6	60	HZ1VTG060060	5410439078658	10	6	HD1	Blister B
6	60	HZ2VTG060060	5410439076609	20	3	HH2	Blister E
6	70	HZ2VTG060070	5410439076593	20	3	HJ1	Blister E
6	80	HZ2VTG060080	5410439076586	20	3	HJ1	Blister E
6	90	HZ2VTG060090	5410439076579	20	3	HK1	Blister E
6	100	HZ2VTG060100	5410439076562	20	3	HK1	Blister E
6	110	HZ2VTG060110	5410439076555	20	3	HL1	Blister E
6	120	HZ2VTG060120	5410439076548	20	3	HL1	Blister E
6	130	HZ2VTG060130	5410439076531	20	1	HN1	Blister G
6	140	HZ2VTG060140	5410439076524	20	1	HP1	Blister G
6	150	HZ2VTG060150	5410439077125	20	1	HQ1	Blister H
6	160	HZ2VTG060160	5410439076517	20	1	HR1	Blister G
6	180	HZ2VTG060180	5410439077132	20	1	HU1	Blister H
6	200	HZ2VTG060200	5410439077149	20	1	HW1	Blister H

HZ2VTG



Hapax houtconstructieschroef met deeldraad en verzonken kop

Vis à bois Hapax à filetage fendu et tête fraisée

Hapax wood construction screw with partial thread and countersunk head

Hapax-Holzbauschraube mit geteiltem Gewinde und Senkkopf



d [mm]	l [mm]	Art. ref.	EAN code			Price code	Packaging
8	80	HZ2VTG080080	5410439077040	10	3	HK1	Blister E
8	100	HZ2VTG080100	5410439077057	10	3	HL1	Blister E
8	120	HZ2VTG080120	5410439077064	10	3	HN1	Blister E
8	140	HZ2VTG080140	5410439077071	10	1	HP1	Blister G
8	160	HZ2VTG080160	5410439077088	10	1	HR1	Blister G
8	180	HZ2VTG080180	5410439077095	10	1	HS1	Blister G
8	200	HZ2VTG080200	5410439077101	10	1	HU1	Blister G

HZ2TTG



Hapax houtconstructieschroef met deeldraad en flenskop

Vis à bois Hapax à filetage fendu et tête à collerette

Hapax wood construction screw with partial thread and flange head

Hapax Holzbauschraube mit geteiltem Gewinde und Flanschkopf



d [mm]	l [mm]	Art. ref.	EAN code			Price code	Packaging
6	30	HZ2TTG060030	5410439076890	15	6	HG1	Blister B
6	40	HZ2TTG060040	5410439076906	15	6	HG1	Blister B
6	50	HZ2TTG060050	5410439076913	15	6	HH1	Blister B
6	60	HZ2TTG060060	5410439076869	15	6	HH2	Blister B
6	70	HZ2TTG060070	5410439076920	15	3	HJ1	Blister E
6	80	HZ2TTG060080	5410439076852	15	3	HJ1	Blister E
6	100	HZ2TTG060100	5410439076845	15	3	HK1	Blister E
6	120	HZ2TTG060120	5410439076937	10	3	HJ1	Blister E
6	140	HZ2TTG060140	5410439076944	10	1	HL1	Blister G
6	160	HZ2TTG060160	5410439076951	10	1	HL1	Blister G
6	180	HZ2TTG060180	5410439076968	10	1	HN1	Blister G
6	200	HZ2TTG060200	5410439076975	10	1	HP1	Blister G
8	40	HZ2TTG080040	5410439076982	10	6	HH2	Blister B
8	50	HZ2TTG080050	5410439076999	10	3	HJ1	Blister E
8	60	HZ2TTG080060	5410439076838	10	1	HK1	Blister 2
8	80	HZ2TTG080080	5410439076821	10	1	HL1	Blister 2
8	100	HZ2TTG080100	5410439076814	10	1	HN1	Blister 2
8	120	HZ2TTG080120	5410439076807	10	1	HP1	Blister 2
8	140	HZ2TTG080140	5410439077002	10	1	HR1	Blister H
8	160	HZ2TTG080160	5410439077019	10	1	HS1	Blister H
8	180	HZ2TTG080180	5410439077026	10	1	HU1	Blister H
8	200	HZ2TTG080200	5410439077033	10	1	HV1	Blister H



Lined writing area with horizontal lines



At pgb-Europe
we invest in
green energy on
a daily base.

Follow us via

LinkedIn, Instagram,
Facebook & Youtube

Contact us.

pgb-Europe
Logistics centre

Gontrode Heirweg 170
9090 Melle
Belgium
T: +32 9 272 70 70
info@pgb-europe.com

www.pgb-europe.com

pgb-Polska
Production plant

Ul. Fryderyka
Wilhelma Redena 3
41 - 807 Zabrze, Polska
T: +48 (32) 330 26 10
biuro@pgb-polska.com

www.pgb-polska.com

pgb-France
Sales office

25 Rue du Champ des Oiseaux
59230 Saint-Amand-les-Eaux
France
T: +33 (0)3 27 21 56 80
info@pgb-france.com

www.pgb-france.com