

WE
BREATHE
FASTENERS®



pgb-Europe is a wholesaler of fastening systems and hand tools. With our wide range of products, we offer our customers a one stop solution.

www.pgb-europe.com

FG
WOOD CONNECTORS®

Quality by **pgb**

WOOD CONNECTORS

All rights reserved.
This catalog may not be reproduced
in whole or in part without the prior
written approval of pgb-Europe nv.

© pgb-Europe nv 2022 - 01

CATALOG





EN

pgb-Europe

pgb-Europe is a Belgian family-owned company specialised in the distribution of fasteners, fixings and hand tools. Our vast range of products allows us to meet the individual needs of every customer.

Intelligent fastening solutions

We want to be a leading company in the domestic market of our field. pgb-Europe distinguishes itself through knowhow, excellent product quality, a high delivery rate and customer-oriented service and sound advice. We stand for a long term partnership with a clear win-win situation, by offering products with added-value. A strong emphasis is put on finding the best and most cost-efficient solution for our clients.

FR

pgb-Europe

pgb-Europe est un fournisseur complet pour les systèmes de fixation et l'outillage. Avec notre large assortiment de produits, nous avons toujours une solution pour nos clients.

Intelligent fastening solutions

Nous aspirons à devenir une société idéale dans notre secteur. pgb-Europe se distingue par les moyens de knowhow, par une qualité de produits irréprochable, par des livraisons régulières et par un excellent service clientèle. Nous sommes également désireux de garder nos partenaires grâce à un esprit de "gagnant" et grâce à la valeur ajoutée de nos produits. Notre seul but est de trouver la meilleure solution pour notre clientèle.

NL

pgb-Europe

pgb-Europe is een Belgische KMO gespecialiseerd in het verdelen van bevestigingsmaterialen en handgereedschappen. Door onze jarenlange ervaring en het uitgebreide productassortiment bieden we elke klant een totaaloplossing.

Intelligent fastening solutions

Wij streven om een toonaangevend bedrijf te zijn binnen onze sector. pgb-Europe onderscheidt zich door knowhow, uitstekende productkwaliteit, een hoge uitleveringsgraad en een klantgerichte service. Wij gaan voor partnerships op lange termijn met een duidelijke win-win situatie, door onze producten van toegevoegde waarde te voorzien. De nadruk ligt steeds op het vinden van de meest gepaste en kostenefficiënte oplossing voor de klant.

DE

pgb-Europe

Die Belgische Firma pgb-Europe NV ist Ihr zuverlässiger Partner für alle Befestigungstechnik und Handwerkzeuge. Unsere langjährige Erfahrung und tiefes Angebotsspektrum tragen dazu bei. Für sie einen kompletten Lösungsanbieter zu bedeuten, der Ihnen das komplette Beschaffungsmanagement spürbar vereinfacht.

Intelligent fastening solutions

pgb verfügt über ein umfangreiches Lieferprogramm und differenziert sich auf dem Markt durch qualitativ hochwertige Produkte, seine Dienstleistung, eine zuverlässige Auslieferungsgrad und Innovation. Und selbstverständlich geht die Betreuung von Kunden bei pgb immer noch weit über das Übliche Maß. Sie erhalten bei uns alles aus einer Hand und wir bieten Ihnen maßgeschneidernde Lösungen. Ausgangspunkt ist eine langjährige, angenehme Geschäftsbeziehung wobei Sie uns als wichtigen Partner schätzen lernen, der stets mit Engagement und Service Ihre Aufträge termingerecht abwickeln werden.



Sustainability

We promote environmental friendly products. Therefore we use chromeVI free zinc plating. For our packaging we use recycled cardboard.

Ook bij pgb-Europe dragen we ons groene steentje bij voor verantwoord ondernemen. Zo worden onze schroeven chromeVI-vrij verzinkt en gebruiken we gerecycleerd karton voor onze verpakking.

Chez pgb-Europe, nous nous responsabilisons également en respectant l'environnement: en effet, notre visserie en zingué ne contient pas de chromeVI et nos produits sont emballés dans des cartons entièrement recyclables.

Auch die pgb Gruppe unterstützt und fördert Umweltbewusstes Handeln. Deshalb legt pgb-Europe ein lagerhaltiges Programm mit Chrom VI-freier Dickschichtpassivierung auf und verwendet Verpackungen aus rezykliertem Karton.



Images

Images, dimensions and holes might subject to variations. Afbeeldingen, afmetingen en gatenpatronen kunnen wijzigingen ondergaan.

Images, dimensions et trous pourraient subir des modifications.

Bilder, Abmessungen und Löcher können sich verändern.

Important notice

Despite the fact that most of the products we supply do not fall under the scope of the RoHS regulations pgb-Europe wants to be active and supportive when dealing with all environmental issues and requirements in general. Therefore Cr6+ yellow zinc plated article items (items with 'GZ' symbol) will be replaced, as much as possible, by white zinc plated article items (Cr3+).

Symbol lexicon



Zinc plated
Verzinkt
Zingué
Verzinkt



BlackTop



Sold per box
Verkocht per doos
Vendu par boîte
Verkauft pro Box



CE | EN conform
Conform CE | EN
Conformité CE | EN
CE | EN Konform



Yellow Zinc plated
Geelverzinkt
Zingué jaune
Verzinkt Gelb



Stainless steel AISI 304
Roestvrij staal AISI 304
Acier inox AISI 304
Rostfrei Stahl AISI 304



Sold per bag
Vendu en sac
Unité de vente
Verkauft im Folienbeutel



ETA - European
Technical approval



Sendzimir zinc plated
Sendzimir verzinkt
Zingué Sendzimir
Sendzimir verzinkt



Stainless steel AISI 316
Roestvrij staal AISI 316
Acier inox AISI 316
Rostfrei Stahl AISI 316



Individually labeld
Individueel gelabeld
Individuellement étiqueté
Individuell etikettiert



Hot dip galvanized
Vuurverzinkt
Galvanisé à chaud
Feuerverzinkt



Plasticized
Geplastificeerd
Plastifié
Plastifiziert



Pieces per outer carton
Stuks per overdoos
Pièces par carton
Stück pro Schachtel





Product Index



	FG0121	Joist hanger - Type A exterior lips Zware balkendrager - Type A uitw. lippen Support poutre - Type A ailes extérieures Balkenschuh - Typ A aussen abgewinkelt	p. 20		FG0259	Safety pintle Veiligheidsstift Axe infraudable Sicherungsstirn	p. 26
	FG0159	Flat connector - Heavy type Koppelplaat - Zwaar type Platinne d'assemblage - Type lourde Flachverbinder - schwer	p. 20		FG0260	Plate pintle - Rustica Plaatduim - Rustica Gond sur platine - Rustica Haken zum aufschrauben - Rustica	p. 26
	FG0188	Square - Heavy type Hoekanker - Zwaar type Equerre - Type lourde Winkelverbinder - schwer	p. 21		FG0265	Adjustable hinge Verstelbare heng Penture réglable Ladenband verstellbar	p. 27
	FG0189	Heavy reinforced square Hoekanker met ril Equerre renforcée - Type lourde Winkelverbinder mit Verstärkungs-Sicke	p. 21		FG0300	Cross hinge light Kruisheng licht Penture légère Kreuzgehänge leicht	p. 27
	FG0233	Cornice bracket - 90° Kroonlijsthaak - 90° Equerre de corniche - 90° Karniesenwinkel - 90°	p. 21		FG0301	Cross hinge - Heavy duty type Kruisheng - Zwaar type Penture en croix - Type lourde Kreuzgehänge - schwer	p. 28
	FG0236	Assembly square multi holes Versterkingshoek multigaten Equerre multi-trous Lochplattenwinkel	p. 22		FG0302	T-strap hinge T-heng Penture anglaise T-Gehänge	p. 28
	FG0237	Door angle - 90° Raamhoek - 90° Equerre pour meubles - 90° Flachwinkel - 90°	p. 22		FG0321	Post holder with anchor plate Paalhouder op plaat Pied de poteau avec patte d'ancrage Pfostenhalter mit Grundplatte	p. 28
	FG0252	Hinge - Rustica Heng - Rustica Penture - Rustica Ladenband - Rustica	p. 23		FG0341	Farmer gate latch Boerenlinkstel met inslagneus Fermeture à l'ancienne Gartentorfalle mit Einschlag Nase	p. 29
	FG0253	Hinge with point Heng met punt Penture pointue Ladenband mit Punkt	p. 24		FG0345	Gate latch Heklink Fermeture barrière Gartentorfalle	p. 29
	FG0254	Shutter hinge - Type T Draailuikheng - Type T Penture équerre - Type T Winkelband - Typ T	p. 24		FG0348	Kick-over latch Luikoverslag Fermeture de volet Schlagladenüberwurf	p. 29
	FG0255	Plate pintle Plaatduim Gond sur platine Haken zum aufschrauben	p. 25		FG0349	Shutter catch "shepherdress" wood thread Herderinnekopje met houtdraad Arrêt tête bergère à vis à bois Fensterlade-Feststeller mit Holzgewinde	p. 30
	FG0256	Pintle for concrete Betonduum Gond à bétonner Haken zum betonieren	p. 25		FG0353	Slide bolt Plaatgrendel Verrou à glissière Grendelriegel	p. 30
	FG0257	Pintle for bricklaying Klaauwduim voor baksteen Gond à maçonner Haken zum einmauern	p. 25		FG0355	Slide bolt for padlock Hangslotgrendel Verrou à porte-cadenas Grendelriegel - abschliessbar	p. 30
	FG0258	Lag screw pintle Schroefduim Gond à vis à bois Haken zum einschrauben	p. 26		FG0381	Shelf bracket without support Plankendrager zonder steun Console sans support Konsole ungestützt	p. 31

Product Index



	FG0384	Ornamental shelf bracket Ornamentale plankendrager Console ornamental Konsole ornamental	p. 31		FG0151	Purlin joint Gordinglas Cantilever Balkenverbinder	p. 44
	FG0385	Shelf bracket Plankendrager Console Konsole	p. 32		FG0153	Roof ridge fixing - left + right Verbindingshoek - links + rechts Pattes de solivage - gauche + droite Sparrenpfettenanker - Links + Rechts	p. 44
	FG0100	Screw nails - Flat conical head Schroefnagel - Ronde platte kop Pointes torsadees - Tête platte conique Schraubennagel - Flachkopf-kegel	p. 36		FG0154	Chocks Gordingklos Echantignoles Knaggen	p. 45
	FG0101	Barbed nails Ringnagels Pointes annelées Rillennägel	p. 36		FG0155	Roof ridge fixing - Type A Hoekverbinder - Type A Patte de solivage - Type A Sparrenpfettenanker - Typ A	p. 45
	FG0102	Clamp nails Klisjesnagel Pointes pour tasseaux Klisjesnagel	p. 36		FG0156	Nailing gusset Spijkerplaat Plaque à clouer Lochplatte	p. 46
	FG0121	Joist hanger - Type A exterior lips Zware balkendrager - Type A uitw. lippen Support poutre - Type A ailes extérieures Balkenschuh - Typ A aussen abgewinkelt	p. 37		FG0158	Multinailing gusset Multi-nagelplaat Platinne à clous Nagelplatte	p. 46
	FG0122	Joist hanger - Inner folded Zware balkendrager inwendige lippen Support poutre à ailes intérieures Balkenschuh nach innen abgewinkelt	p. 39		FG0159	Flat connector - Heavy type Koppelplaat - Zwaar type Platinne d'assemblage - Type lourde Flachverbinder - schwer	p. 47
	FG0123	Joist hanger - 2-parts (left + right) Zware balkendrager - 2-delig (l + r) Support poutre - 2 éléments (g + d) Balkenschuh - 2-teilig (links + rechts)	p. 39		FG0160	Anchor plate Verbindingsplaat Platinne d'assemblage Lochplatten	p. 48
	FG0126	Beamsupport with long lip Balkdrager met lange lip Support poutre avec lèvres longue Balkenschuh mit lange Lasche	p. 40		FG0161	Coat rack plate Kapstok ophangoog Platine porte-manteau Rahmenöse	p. 49
	FG0128	Beamsupport without lip Balkdrager zonder lip Support poutre sans lèvres Balkenschuh ohne Lasche	p. 41		FG0162	Fish plate Koppelplaat Plaque d'assemblage Flachverbinder	p. 49
	FG0136	Joist hanger with strap Raveeldrager met strip Support poutre à lèvres à plier Pfettenverbinder	p. 42		FG0163	Strap anchor Koppelanker Ancrage d'accouplement Flachverbinder	p. 49
	FG0141	Universal coner joint Universeel hoek gripanker Patte-equerre d'ancrage universel Eckverbinder universal	p. 42		FG0164	Strap anchor Koppelanker Ancrage d'accouplement Flachverbinder	p. 50
	FG0142	Light joist hanger - Type U Regeldrager - Type U Support poutre - Type U Balkenschuh - Typ U	p. 43		FG0166	Connector - Narrow type Verbindingsplaat - Smal type Platine de connection - Type étroite Verbindungsplatte - schmal	p. 50
	FG0144	Truss clip - vertical Trussclip - verticaal Pied de fermette - Verticalement Balkenverbinder - Vertikal	p. 43		FG0168	T-anchor plate - Connecting IPN/wood Verbindingsplaat - IPN/hout Ancrages IPN - Liaison IPN/bois HE-anker T-Träger/Holz balken	p. 52

Product Index



	FG0169	Anchor square Betonanker Equerre d'ancrage à sceller Betonflachstahlanker	p. 52		FG0190	Anchor square for wood/concrete Hoekanker voor hout/beton Equerre d'ancrage pour bois/béton Winkelverbinder Holz/Beton	p. 59
	FG0170	Corrugated assembly belt/plastic box Gegolfde gaatjesband in cassette Bande perfo ondulée en cassette Windrispenband gewellt in Kasette	p. 52		FG0206	Mounting tabs for wooden frames Raamklauw voor houten ramen Pattes de fixation de fenêtres bois Montagelaschen für Holzrahmen	p. 59
	FG0171	Straight assembly belt/plastic box Rechte gaatjesband in cassette Bande perfo droite en cassette Windrispenband recht in Kasette	p. 53		FG0210	Multi angle bracket - 90° Kozijnhoek met ril - 90° Equerre nervurée droite - 90° Winkel mit Rille - 90°	p. 59
	FG0172	Straight assembly belt Rechte gaatjesband Bande perforée droite Windrispenband recht	p. 53		FG0227	Narrow square Stoelhoek Equerre chaise Stuhlwinkel	p. 60
	FG0173	Straight assembly belt Rechte gaatjesband Bande perforée droite Windrispenband recht	p. 54		FG0227	Narrow square with screws Stoelhoek met schroeven Equerre chaise avec vis Stuhlwinkel mit Schrauben	p. 62
	FG0174	Angled lug Beton hoekanker Equerre de fixation béton Betonwinkel	p. 55		FG0228	Narrow square - Heavy type Dorpelhoek - Zwaar type Equerre porte - Type lourde Winkelverbinder schwer	p. 63
	FG0175	Straight assembly belt Rechte gaatjesband Bande perforée droite Windrispenband recht	p. 55		FG0230	Reinforced corner skew - 135° Neusijzer - 135° Equerre asymétrique - 135° Winkelverbinder - 135°	p. 63
	FG0178	Straight assembly belt Rechte gaatjesband Bande perforée droite Windrispenband recht	p. 55		FG0231	Merging square - 135° Koppelplaat - 135° Equerre d'assemblage - 135° Strebenverbinder - 135°	p. 63
	FG0179	Ridge piece support Ruitesteun Cavalier rehausse pour charpente Firstlattenhalter	p. 56		FG0233	Cornice bracket - 90° Kroonlijsthaak - 90° Equerre de corniche - 90° Karniesenwinkel - 90°	p. 64
	FG0185	Reinforced adjustable square Verstelbaar hoekanker met ril Equerre ajustable renforcée Winkelverbinder abstelbar mit Sicke	p. 56		FG0235	Assembly square scalene Ongelijkbenige versterkingshoek Equerre simple scalène Lochplattenwinkel ungleichschenkelig	p. 64
	FG0186	Reinforced square Hoekanker met ril en afgeschuinde hoeken Equerre renforcée Winkelverbinder mit Sicke	p. 57		FG0236	Assembly square multi holes Versterkingshoek multigaten Equerre multi-trous Lochplattenwinkel	p. 65
	FG0187	Adjustable square Verstelbaar hoekanker Equerre ajustable Winkelverbinder mit Kombiloch	p. 57		FG0236	Assembly square multi holes with screws Versterkingshoek multigaten met schroeven Equerre multi-trous avec vis Lochplattenwinkel mit Schrauben	p. 66
	FG0188	Square - Heavy type Hoekanker - Zwaar type Equerre - Type lourde Winkelverbinder - schwer	p. 58		FG0237	Door angle - 90° Raamhoek - 90° Equerre pour meubles - 90° Flachwinkel - 90°	p. 66
	FG0189	Heavy reinforced square Hoekanker met ril Equerre renforcée - Type lourde Winkelverbinder mit Verstärkungs-Sicke	p. 58		FG0240	T-ridge T-verbindingsplaat Equerre modèle T T-winkel	p. 67

Product Index



	FG0241	Assembly square multi holes Versterkingshoek multigaten Equerre multi-trous Lochplattenwinkel	p. 68		FG0303	Straight strap hinge - Light version Staartheng - Licht type Penture anglaise double - Type légère Scharnier - leicht	p. 77
	FG0242	Frame connector Versterkingshoek Equerre symétrique Breitwinkel	p. 68		FG0304	Double tailhinge - Heavy version Dubbele staartscharnier - Zwaar type Penture double - Type forte Doppelten Kistenband - schwer	p. 77
	FG0243	T-ridge large T-verbingsplaat - Breed Equerre en T - Large T-Winkel - breit	p. 69		FG0307	Adjustable anchor Verstelbaar instortanker m. pin Ancrage réglable Stützenfuss verstellbar mit Stange	p. 78
	FG0251	Straight hinge Rechte heng Penture droite Ladenband gerade	p. 72		FG0310	Column shoe with rebar - Type L Balkenvoet met betonijzer - Type L Pied de poteau avec fer de béton - Type L Pfosträger mit Riffeldolle - Typ L	p. 78
	FG0253	Hinge with point Heng met punt Penture pointue Ladenband mit Punkt	p. 72		FG0311	Column shoe with rebar - Type T Balkenvoet met betonijzer - Type T Pied de poteau avec fer de béton - Type T Pfosträger mit Riffeldolle - Typ T	p. 78
	FG0254	Shutter hinge - Type T Draailuikheng - Type T Penture équerre - Type T Winkelband - Typ T	p. 73		FG0312	Column shoe with rebar - Type U Balkenvoet met betonijzer - Type U Pied de poteau avec fer de béton - Type U Pfosträger mit Riffeldolle - Typ U	p. 79
	FG0255	Plate pintle Plaatduim Gond sur platine Haken zum aufschrauben	p. 73		FG0313	Pergola support with rebar Pergolasteun met betonijzer Support de pergola avec fer pour béton Pergola-Unterstützung mit Dolle	p. 79
	FG0256	Pintle for concrete Betonduim Gond à bétonner Haken zum betonieren	p. 73		FG0316	Column shoe with anchoring pl. - Type U Balkenvoet met bevestigingspl. - Type U Pied de poteau avec patte de fix. - Type U Pfosträger zum aufdübeln - Typ U	p. 79
	FG0257	Pintle for bricklaying Klauwduim voor baksteen Gond à maçonner Haken zum einmauern	p. 74		FG0317	Column shoe - Type U Balkenvoet met opschroefb. steun - Type U Support de poutre - Type U Pfosträger U mit Balkenauflage	p. 80
	FG0258	Lag screw pintle Schroefduim Gond à vis à bois Haken zum einschrauben	p. 74		FG0319	Fence holder - Type L Vlechtscherersteun - Type L Support panneau tresse - Type L Flechtzaunbeschlag - Typ L	p. 80
	FG0259	Safety pintle Veiligheidsstift Axe infraudable Sicherungsstift	p. 75		FG0320	Pointed pole anchor Paalhouder met punt Pied de poteau de jardin pointu Pfosträger Räkete	p. 80
	FG0300	Cross hinge - Light version Kruisheng - Licht type Penture en croix - Type Légère Kreuzgehänge - leicht	p. 75		FG0321	Post holder with anchor plate Paalhouder op plaat Pied de poteau avec patte d'ancrage Pfosträger mit Grundplatte	p. 81
	FG0301	Cross hinge - Heavy duty type Kruisheng - Zwaar type Penture en croix - Type lourde Kreuzgehänge - schwer	p. 76		FG0322	Hight adjustable post holder - Type P Paalhouder verstelbare hoogte - Type P Pied de poteau ajustable en hauteur - Type P Pfosträger Höhenverstellung - Typ P	p. 81
	FG0302	T-Hinge T-Heng Penture anglaise T-Gehänge	p. 76		FG0324	Fence holder combi Vlechtscherersteun combi Support panneau tresse combi Flechtzaunbeschlag combi	p. 81

























Product Index



	FG0325	Fence holder Type L with screws Vlechtschermsteun Type L met schroeven Support panneau tresse Type L avec vis Flechtzaunbeschlag Typ L mit Schrauben	p. 82		FG0345	Gate latch Hekklank Fermeture barrière Gartentorfall	p. 89
	FG0326	Fence holder Type U Vlechtschermsteun Type U Support panneau tresse Type U Flechtzaunbeschlag Typ U	p. 83		FG0348	Kick-over latch Luikoverslag Fermeture de volet Schlagladenüberwurf	p. 89
	FG0327	Bracket for panel fencing Draadpaneelklem Fixation treillis Befestigungsschele	p. 84		FG0349	Shutter catch "shepherdress" wood thread Herderinnekopje met houtdraad Arrêt tête bergère à vis à bois Fensterlade-Feststeller mit Holzgewinde	p. 90
	FG0328	Column shoe adj. in height and width Verstelbare voet in hoogte en breedte Pied de poteau réglable en hauteur et largeur Pfostentr. höhen- und seitenverstellb.	p. 84		FG0351	Barrel bolt Bajonetgrendel Verrou à baionette Bolzenstangenriegel	p. 90
	FG0329	Pole cover - Pyramid type Paalkap - piramidevormig Ornement de poteau - Forme pyramide Pfostenkappe - Pyramideförmig	p. 84		FG0352	Slide bolt - American type Amerikaanse grendel Verrou à glissière - Type Américaine Grendelriegel - Amerikanische typ	p. 91
	FG0330	Pole cover - Ball type Paalkap - bolvormig Ornement de poteau - Forme boule Pfostenkappe - Kugelförmig	p. 85		FG0353	Slide bolt Plaatgrendel Verrou à glissière Grendelriegel	p. 91
	FG0331	Plane sliding latch - Light version Vlakke schuif - Licht type Verrou de fenetre plat - Type légère Fensterriegel gerade	p. 86		FG0354	Slide bolt for padlock Hangslotgrendel met oogslot achteraan Verrou à porte-cadenas Grendelriegel - abschliessbar	p. 91
	FG0332	Plane window sliding latch Vlakke raamschuif Verrou pêne plat bouton Schlossriegel gerade	p. 86		FG0355	Slide bolt for padlock Hangslotgrendel Verrou à porte-cadenas Grendelriegel - abschliessbar	p. 92
	FG0333	Plane roll latch Vlakke deurrolschuif Verrou à coulisse Rollen-Schlossriegel gerade	p. 87		FG0356	Slide bolt for padlock Hangslotgrendel Verrou à porte-cadenas Grendelriegel - abschliessbar	p. 92
	FG0334	Flat padlock sliding bolt Vlakke hangslotrolschuif Verrou pour cadenas à rouleau plat Rollenschlossriegel flach	p. 87		FG0357	Security bolt for pig stable Varkenshok veiligheidsgrendel Verrou d'étable de sécurité Sicherheitsstallriegel	p. 92
	FG0336	Plane latch for padlock Vlakke hangslotschuif Verrou à porte-cadenas plat Schlossriegel gerade	p. 88		FG0358	Pistol latch Pistoolgrendel Verrou pistolet Pistolriegel	p. 93
	FG0341	Farmer gate latch Boerenklinkstel met inslagneus Fermeture à l'ancienne Gartentorfall mit Einschlagnase	p. 88		FG0380	Shelf bracket - Heavy type Plankendrager met steun - Zwaar type Support de table - Lourd Konsolenstutze - schwer	p. 96
	FG0343	Garden gate latch Tuinheksluiting Fermeture porte de jardin Gartentorfall	p. 88		FG0382	Pressed shelf bracket - Type 1 Geperste plankendrager - Type 1 Console emboutie - Type 1 Blechkonsole - Typ 1	p. 97
	FG0344	Gate latch automatic Heksluiting automatisch Fermeture porte de jardin automatique Gartentorfall automatisch	p. 89		FG0383	Pressed shelf bracket - Type 2 Geperste plankendrager - Type 2 Console emboutie - Type 2 Blechkonsole - Typ 2	p. 97

Product Index



	FG0384	Ornamental shelf bracket Ornamentale plankendrager Console ornamental Konsole ornamental	p. 98		FG0563	Rim shuttering anchor Randbekistingsanker Ancrage pour margelle Randschalungsanker	p. 106
	FG0385	Shelf bracket Plankendrager Console Konsole	p. 98		FG0586	Wall anchor plate centre Muurplaatanker plaat centrisch Tirant de mur plaque centrée Steinanker platte zentrisch	p. 106
	FG0388	Foldable shelf bracket Inklapbare plankendrager Console pliable Konsole klappbar	p. 98		FG0599	Storm anchor Stormanker Ancrage tempête Windsoganker	p. 107
	FG0413	Timber connector double sided Kramplaat dubbelzijdig getand Crampon double denture Holzverbinder dorne zweiseitig	p. 99		FG0601	Storm anchorage Opwaaianker Ancrage tempête Windsoganker	p. 107
	FG0421	Rolled knuckle hinge straight corners Gerolde knopscharnier rechte hoeken Charniere à noeud angle droite 90° Stangenscharnier gerollt Winkel 90°	p. 99		FG0606	Cramp iron Bintanker Ancrage bois/maçonnerie Balkenanker	p. 107
	FG0422	Rolled hinge round corners and head Gerolde scharnier ronde hoeken en bolkop Charniere roulee angle arrondi et tête ronde Geroldes scharn. Hecke abger. und Rundkopf	p. 100		FG0651	Thin joint tie Prikspouwanker Crochet mur creux à collar Prik-Luftschtanker	p. 108
	FG0423	Rolled knuckle hinge straight corners-plug Gerolde knopsch. rechte hoeken en vaaskop Charn. à noeuds roulee angle 90°-vase Stangenscharnier gerollt Winkel 90° stopfen	p. 100		FG0661	Universal wall tie - L type Universeel L-spouwanker Crochet mur en L universel Universal L-Luftschtanker	p. 108
	FG0424	Rolled knuckle hinge rounded corners-plug Gerolde knopsch. ronde hoeken en vaaskop Charn. à noeuds roulee angl. arrondis-vase Stangenscharn. gerollt Winkel abger.-stopfen	p. 101		FG0663	Wall tie - Mono Spouwanker - Mono Crochet mur - Mono Luftschtanker - Mono	p. 109
	FG0517	Wall junction strip Lijmkoppelstrip Raccord à collar Mauerverbinder	p. 104		FG0664	Wall tie with wood thread - L type L-spouwanker met houtdraad Crochet mur à filet bois - Type L Luftschtanker mit Holzgewinde - Typ L	p. 110
	FG0521	Flexible wall clamp Uizetbaar wandanker Ancrage mur dilatant Wandanker beweglich	p. 104		FG0671	Selftapping wall tie Slagspouwanker Crochet mur creux à clouer Dübelanker mit Einschlaggewinde	p. 110
	FG0523	Spring anchor Veeranker Ancrage dilatant Federanker	p. 105				
	FG0526	Slip tie Glijanker Tige de dilatation lisse Gleitanker	p. 105				
	FG0531	Window frame anchor wood thread Kozijnanker met houtdraad Fixation de chambranle filet bois Zargenanker mit Holzgewinde	p. 105				
	FG0534	Frame anchor - l + r Lijmkozijnanker - l + r Ancre chambranle à collar - g + d Zargenanker zum verkleben - l + r	p. 106				



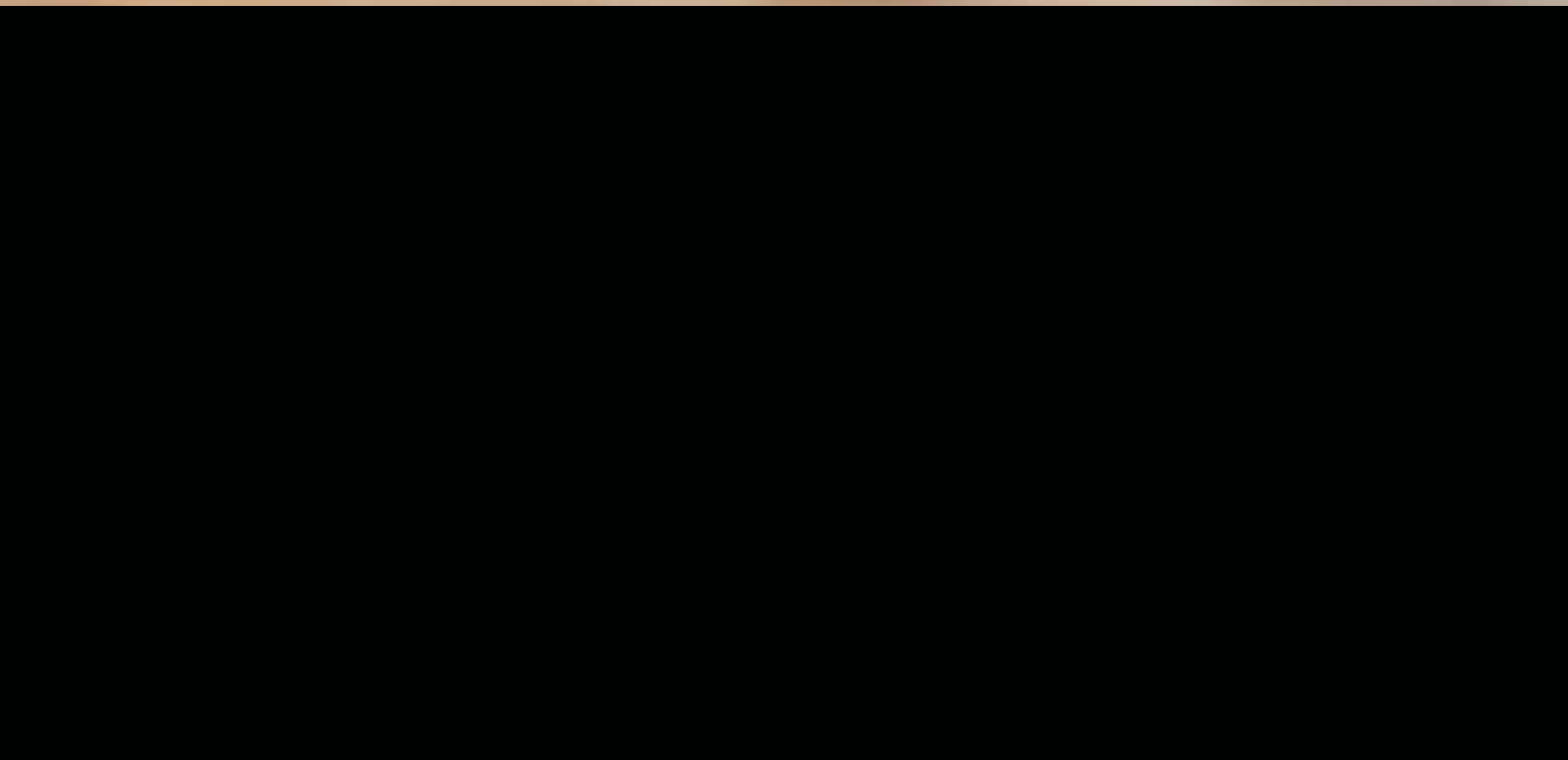



BlackTop has it covered

EN

BlackTop coating is a deep black surface treatment with high corrosion resistance, a low layer thickness and an even black gloss effect. It is the ideal surface treatment for those looking for a black finish with high corrosion resistance (500h SST). Should the strong BlackTop be damaged, the underlying zinc layer will continue to protect the material.

Naturally, the BlackTop surface treatment is free of harmful substances and complies with the European REACH and RoHS guidelines.

“Materials with the BlackTop coating guarantee a high corrosion resistance (500h SST) and ensure a beautiful and advanced finish of all your projects.”

NL

BlackTop is een diepzwarte oppervlaktebehandeling met een hoge corrosieresistentie, een geringe laagdikte en geeft een egaal zwart glanzend effect. Het is de ideale oppervlaktebehandeling voor wie op zoek is naar een zwarte afwerking met hoge corrosiewering (500h sst). Indien de toplaag beschadigd raakt, dan is er nog steeds de onderliggende zinklaag die voor bescherming van het materiaal zorgt.

Uiteraard is de BlackTop oppervlaktebehandeling vrij van schadelijke stoffen en voldoet ze hierbij aan de Europese richtlijnen REACH en RoHS.

“Materialen met BlackTop label indicatie staan garant voor 500h SST en zorgen voor een mooie uitstraling van al uw projecten.”

FR

BlackTop Coating est un traitement de surface noir profond avec une haute résistance à la corrosion, une faible épaisseur de couche et un effet de brillance noir uniforme. C'est le traitement de surface idéal pour ceux qui recherchent une finition noire avec une haute résistance à la corrosion (500h sst). Si le BlackTop résistant est endommagé, la couche de zinc sous-jacente protège le matériau.

Naturellement, le traitement de surface BlackTop est exempt de substances nocives et est conforme aux directives européennes REACH et RoHS.

“Les matériaux dotés du revêtement BlackTop garantissent une résistance élevée à la corrosion (500h SST) et assurent une finition magnifique et avancée de tous vos projets.”



EN

Use

The use of black fasteners has gained popularity. That's why we have created the high-quality BlackTop range. After all, products that have been treated with the BlackTop coating can be used for many applications.

The most common applications are the installation of blackened hinges, handles and other types of black fasteners.

Advantages

Materials with the BlackTop coating guarantee a high corrosion resistance (500h SST) and ensure a beautiful and advanced finish of all your projects.

Thanks to the progressive performance of BlackTop, including the underlying zinc layer which continuously provides protection when the black top layer is damaged and the integrated wax which ensures that the materials will keep fitting, you can enjoy an optimal and long-lasting fixation.

Ideal for outdoor applications

Products with the BlackTop coating are extremely suitable for outdoor applications. Thanks to the corrosion-resistant properties of the coating, fasteners and fixings remain protected against various environmental factors and the elements, such as rain and wind.

With this coating you do not only opt for functionality, but also for a sustainable solution that contributes to the lifespan of your fasteners. In short, with BlackTop you will enjoy the aesthetically pleasing result for longer.

NL

Gebruik

Het gebruik van zwart bevestigingsmateriaal heeft aan populariteit gewonnen. Daarom hebben we de kwalitatieve BlackTop range in het leven geroepen. Producten die een BlackTop Coating krijgen, kunnen immers gebruikt worden voor heel wat toepassingen.

De meest gangbare toepassingen zijn het monteren van zwarte scharnieren, hengen en andere soorten van zwart beslag.

Voordelen

Materialen met BlackTop Coating staan garant voor 500h SST en zorgen voor een mooie uitstraling van al uw projecten.

Indien de BlackTop laag beschadigd raakt, dan zorgt de onderliggende zinklaag nog steeds voor bescherming. Daarenboven zorgt de geringe laagdikte en het geïntegreerde smeermiddel voor een ideale oplossing zodat materialen steeds op elkaar blijven passen, bv. bouten en moeren.

Ideaal voor buitentoepassingen

Producten die voorzien zijn van de BlackTop coating, zijn uiterst geschikt voor buitentoepassingen. Dankzij de corrosiebestendige eigenschappen van de coating blijven producten en bevestigingen langer beschermd tegen de verschillende omgevingsfactoren, zoals bv. regen en wind.

Met deze coating kiest u niet alleen voor een duurzame oplossing voor uw bevestigingen, maar geniet u ook langer van een esthetisch ogend resultaat.

FR

Usage

L'utilisation d'éléments de fixation noirs a gagné en popularité. C'est pourquoi nous avons créé la gamme qualitative BlackTop Coating.

En effet, les produits dotés d'un revêtement BlackTop peuvent être utilisés pour un grand nombre d'applications. Les applications les plus courantes sont le montage de charnières et de poignées noircies et d'autres types de ferrures noires.

Avantages

Les matériaux dotés du revêtement BlackTop garantissent une résistance élevée à la corrosion (500h SST) et assurent une finition magnifique et avancée de tous vos projets.

Grâce à la performance progressive de BlackTop, y compris la couche de zinc sous-jacente qui continue à fournir une protection lorsque la couche noire 'Top' est endommagée et la cire intégrée qui assure que les matériaux continuent à s'adapter, vous pouvez profiter d'une fixation optimale et durable.

Idéal pour les applications extérieures

Les produits dotés du BlackTop Coating conviennent parfaitement aux applications extérieures. Grâce aux propriétés anticorrosion du revêtement, les produits et les fixations restent protégés plus longtemps contre divers facteurs environnementaux, tels que la pluie et le vent.

Avec ce revêtement, vous ne choisissez pas seulement une solution durable pour vos fixations, mais vous profitez également d'un résultat esthétique plus durable.

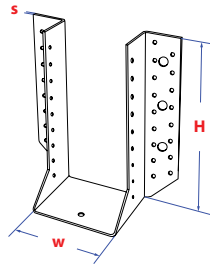

FG0121



DoPn° FG121001

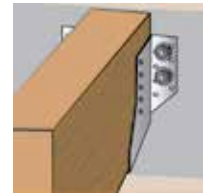

Joist hanger - Type A exterior lips
Zware balkendrager - Type A uitwendige lippen

Support poutre - Type A ailes extérieures
Balkenschuh - Typ A aussen abgewinkelt

**Black
Top**

Art. Nr.	EAN Code	w [mm]	H [mm]	s [mm]	Hole pattern Dia. of the hole/nr. of holes	
FG01210030461025	5410439151610	46	102	2	Ø5/18 - Ø7/1 - Ø11/4	10
FG01210030501055	5410439150811	50	100	2	Ø5/22 - Ø7/1 - Ø11/4	10
FG01210030630985	5410439151658	63	93	2	Ø5/22 - Ø7/1 - Ø11/4	10
FG01210030631185	5410439151665	63	118	2	Ø5/28 - Ø7/1 - Ø11/4	10
FG01210030631585	5410439150910	63	158	2	Ø5/34 - Ø7/1 - Ø11/4	10
FG01210030751305	5410439150958	75	130	2	Ø5/34 - Ø7/1 - Ø11/4	10
FG01210030751825	5410439150972	75	182	2	Ø5/22 - Ø7/1 - Ø11/4	10

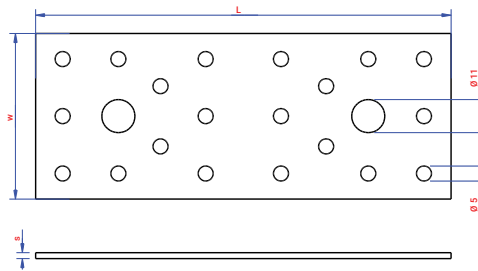

FG0159



FG159001

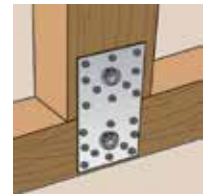

Flat connector - Heavy type
Koppelplaat - Zwaar type

Platine d'assemblage - Type lourde
Flachverbinder - schwer

**Black
Top**

Art. Nr.	EAN Code	w [mm]	L [mm]	s [mm]	Hole pattern Dia. of the hole/nr. of holes	
FG01590030401005	5410439151672	35	97	2,5	Ø5/8 - Ø11/2	25
FG01590030551405	5410439151689	55	138	2	Ø5/20 - Ø13/2	25

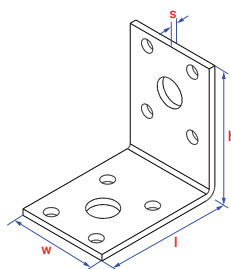

FG0188



DoPh® FG188001



Square - Heavy type
Hoekanker - Zwaar type

Equerre - Type lourde
Winkelverbinder - schwer

Black
Top

Art. Nr.	EAN Code	w [mm]	l [mm]	s [mm]	h [mm]	Hole pattern Dia. of the hole/nr. of holes	
FG01880030350505	5410439151139	35	50	2,5	50	Ø5/8 - Ø10,4/2	50
FG01880030600905	5410439151696	60	90	2,5	90	Ø5/16 - Ø11/4	50

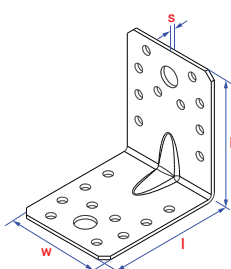

FG0189



DoPh® FG189001



Heavy reinforced square
Hoekanker met ril

Equerre renforcée - Type lourde
Winkelverbinder mit Verstärkungs-Sicke

Black
Top

Art. Nr.	EAN Code	w [mm]	l [mm]	s [mm]	h [mm]	Hole pattern Dia. of the hole/nr. of holes	
FG01890030550705	5410439151702	55	70	2	70	Ø5/12 - Ø11/2	50
FG01890030650905	5410439151153	60	90	2,5	90	Ø5/20 - Ø11/2	50

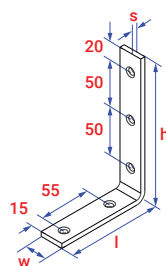

FG0233



Cornice bracket - 90°
Kroonlijsthaak - 90°

Equerre de corniche - 90°
Karniesenwinkel - 90°

Black
Top

Art. Nr.	EAN Code	h [mm]	l [mm]	s [mm]	w [mm]	Hole pattern Dia. of the hole/nr. of holes	
FG02330031501105	5410439269155	150	110	5	25	Ø5,5/4	25

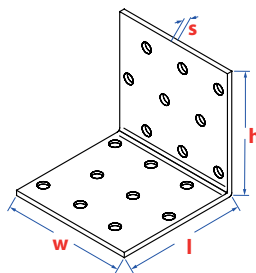

FG0236



DoPn° FG236001A



Assembly square multi holes
Versterkingshoek multigaten

Equerre multi-trous
Lochplattenwinkel

Black
Top

Art. Nr.	EAN Code	w [mm]	l [mm]	s [mm]	h [mm]	Hole pattern Dia. of the hole/nr. of holes	
FG02360030300305	5410439151450	30	30	2	30	-	50
FG02360030400405	5410439151443	40	40	2	40	Ø5/6	50
FG02360030400505	5410439151436	40	50	2	50	Ø5/12	50
FG02360030400605	5410439151429	40	60	2,5	60	Ø5/10	50
FG02360030600605	5410439151412	60	60	2	60	Ø5/18	20

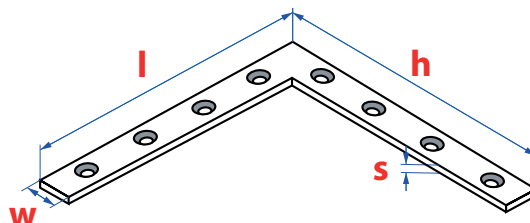

FG0237



Door angle - 90°
Raamhoek - 90°

Equerre pour meubles - 90°
Flachwinkel - 90°

Black
Top

Art. Nr.	EAN Code	w [mm]	l [mm]	s [mm]	h [mm]	Hole pattern Dia. of the hole/nr. of holes	
FG02370030140705	5410439151405	14	70	2	70	Ø4/4	50
FG02370030181005	5410439151399	18	100	1,5	100	Ø4/5	50
FG02370030181205	5410439151382	18	120	2	120	Ø4/5	50
FG02370030231505	5410439151375	23	150	2,5	150	Ø4/5	50

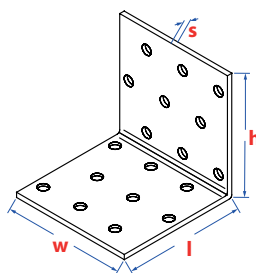

FG0241

LABELED
PER PIECE

DoPn° FG241001A



Assembly square multi holes
Versterkingshoek multigaten

Equerre multi-trous
Lochplattenwinkel

Black
Top

Art. Nr.	EAN Code	w [mm]	l [mm]	s [mm]	h [mm]	Hole pattern Dia. of the hole/nr. of holes	
FG02410030600405	5410439151177	60	40	2,5	40	Ø5/5 - Ø5/10	50
FG02410030800805	5410439151191	80	80	2,5	80	Ø5/10 - Ø5/10	50

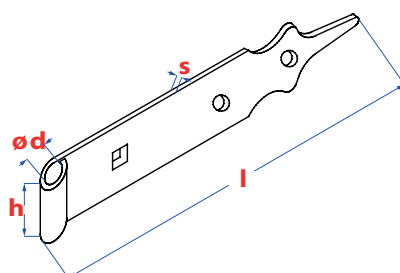

FG0252

LABELED
PER PIECE

Hinge - Rustica
Heng - Rustica

Penture - Rustica
Ladenband - Rustica

Black
Top

Art. Nr.	EAN Code	d [mm]	l [mm]	s [mm]	h [mm]	Hole pattern Dia. of the hole/nr. of holes	
FG02520031604005	5410439442640	16	400	5	44	Ø8,2/2 - Ø8,3/1	10
FG02520031606005	5410439442664	16	600	5	44	Ø8,2/3 - Ø8,3/1	10
FG02520031608005	5410439442688	16	800	5	44	Ø8,2/4 - Ø8,3/1	10
FG02520031610005	5410439442701	16	1000	5	44	Ø8,2/5 - Ø8,3/1	10

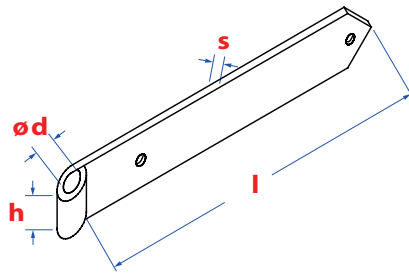

FG0253



Hinge with point
Heng met punt

Penture pointue
Ladenband mit Punkt

Black
Top

Art. Nr.	EAN Code	d [mm]	l [mm]	s [mm]	h [mm]	Hole pattern Dia. of the hole/nr. of holes	
FG02530031606005	5410439569224	16	600	5	45	Ø8,5/3	6
FG02530031607005	5410439569248	16	700	5	45	Ø8,5/3	6
FG02530031608005	5410439569262	16	800	5	45	Ø8,5/4	2
FG02530031610005	5410439569330	16	1000	5,5	45	Ø8,5/5	6
FG02530031612005	5410439569354	16	1200	5,5	45	Ø8,5/5	6
FG02530031802005	5410439569378	18	200	4	30	Ø8,5/2	10
FG02530031802505	5410439569439	18	250	4	30	Ø8,5/3	10
FG02530031803005	5410439569392	18	300	4	30	Ø8,5/3	10
FG02530031803505	5410439569415	18	350	4	30	Ø8,5/3	10
FG02530031804005	5410439569453	18	400	4	30	Ø8,5/4	10
FG02530031805005	5410439569477	18	500	4	30	Ø8,5/5	10

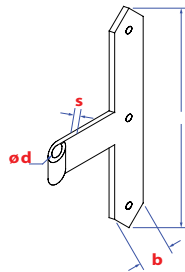

FG0254



Shutter hinge - Type T
Draailuikheng - Type T

Penture équerre - Type T
Winkelband - Typ T

Black
Top

Art. Nr.	EAN Code	d [mm]	l [mm]	b [mm]	s [mm]	Hole pattern Dia. of the hole/nr. of holes	
FG02540031801505	5410439569583	18	150	30	4	Ø8,5/3	10
FG02540031802005	5410439569606	18	200	30	4	Ø8,5/3	10

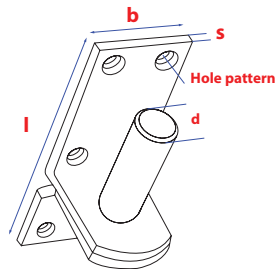

FG0255

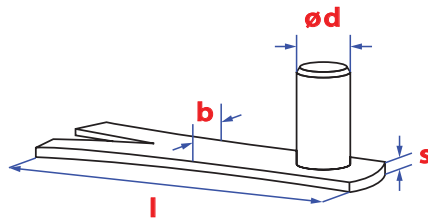

Plate pintle
Plaatduim

Gond sur platine
Haken zum aufschrauben

Black
Top

Art. Nr.	EAN Code	d [mm]	l [mm]	b [mm]	s [mm]	Hole pattern Dia. of the hole/nr. of holes	
FG02550031645385	5410439569699	16	45	40	5	Ø6,2/6	10
FG02550031835305	5410439569712	18	40	33	4	Ø5,5/6	10



FG0256



Pintle for concrete
Betonduim

Gond à bétonner
Haken zum betonieren

Black
Top

Art. Nr.	EAN Code	d [mm]	l [mm]	b [mm]	s [mm]	
FG0256003181055	5410439625135	18	105	30	4	10

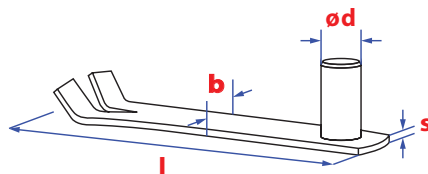

FG0257



Pintle for bricklaying
Klauwduim voor baksteen

Gond à maçonner
Haken zum einmauern

Black
Top

Art. Nr.	EAN Code	d [mm]	l [mm]	b [mm]	s [mm]	
FG0257003181505	5410439625081	18	150	30	4	10

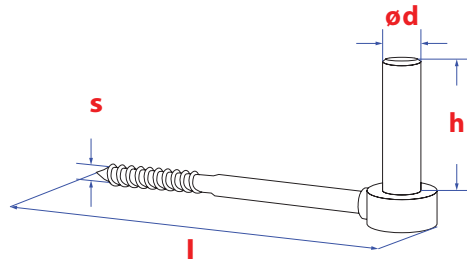

FG0258



Lag screw pintle
Schroefduim

Gond à vis à bois
Haken zum einschrauben

Black
Top

Art. Nr.	EAN Code	d [mm]	l [mm]	s [mm]	h [mm]	
FG0258003161455	5410439624565	16	145	10	55	10
FG0258003181005	5410439624541	18	100	12	35	10

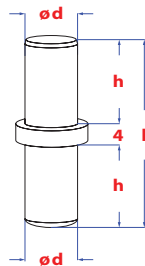

FG0259



Safety pintle
Veiligheidsstift

Axe infraudable
Sicherungsdom

Black
Top

Art. Nr.	EAN Code	d [mm]	l [mm]	h [mm]	
FG0259003180755	5410439625173	18	75	35	10

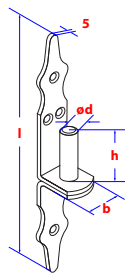

FG0260



Plate pintle - Rustica
Plaatduim - Rustica

Gond sur platine - Rustica
Haken zum aufschrauben - Rustica

Black
Top

Art. Nr.	EAN Code	d [mm]	l [mm]	b [mm]	Hole pattern Dia. of the hole/nr. of holes	
FG02600031645455	5410439458085	16	45	44	Ø7,6/4	10

FG0265

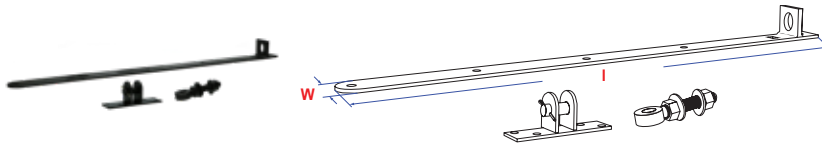

Adjustable hinge
Verstelbare heng

Penture réglable
Ladenband verstellbar

Black
Top

Art. Nr.	EAN Code	w [mm]	l [mm]	
FG02650024007005	5410439274203	40	700	10

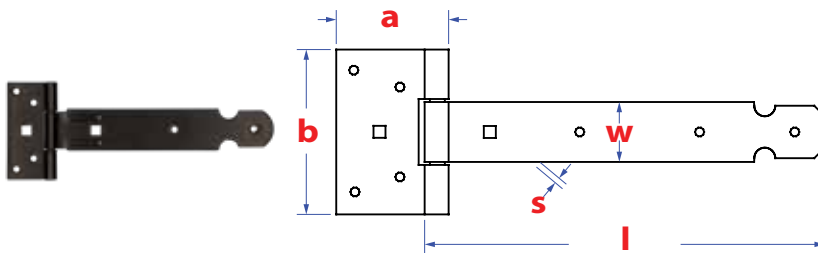

FG0300

Cross hinge light
Kruisheng licht

Penture légère
Kreuzgehänge leicht

Black
Top

Art. Nr.	EAN Code	w [mm]	l [mm]	s [mm]	Hole pattern Dia. of the hole/nr. of holes	
FG03000030352005	5410439482110	35	200	2	Ø5,2/6 - Ø8,8/2	6
FG03000030352505	5410439482127	35	250	2	Ø5,2/6 - Ø8,8/2	6
FG03000030353005	5410439482134	35	300	2	Ø5,2/7 - Ø8,8/2	6
FG03000030354005	5410439482141	35	400	2	Ø5,2/8 - Ø8,8/3	6
FG03000030355005	5410439482158	35	500	2	Ø5,2/9 - Ø8,8/5	6

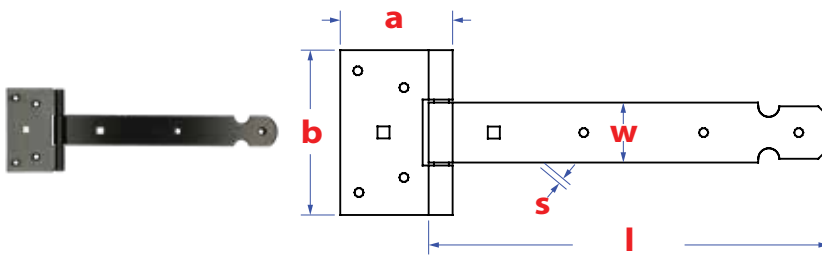

FG0301



Cross hinge - Heavy duty type
Kruisheng - Zwaar type

Penture en croix - Type lourde
Kreuzgehänge - schwer

Black
Top

Art. Nr.	EAN Code	w [mm]	l [mm]	s [mm]	Hole pattern Dia. of the hole/nr. of holes	
FG03010030403005	5410439482059	40	300	4	Ø6,4/2 - Ø5,5/4 - Ø8,4/2	6
FG03010030404005	5410439482066	40	400	4	Ø6,4/2 - Ø5,5/4 - Ø8,4/2	6
FG03010030405005	5410439482073	40	500	4	Ø6,4/3 - Ø5,5/4 - Ø8,4/2	6
FG03010030406005	5410439482080	40	600	4		6

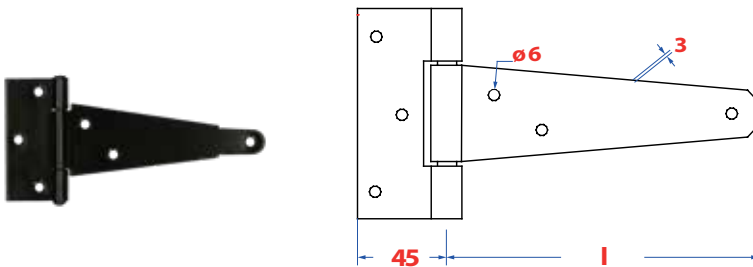

FG0302



T-strap hinge
T-heng

Penture anglaise
T-Gehänge

Black
Top

Art. Nr.	EAN Code	l [mm]	
FG03020031005	5410439628648	100	12
FG03020031255	5410439628662	125	12
FG03020031505	5410439628686	150	12

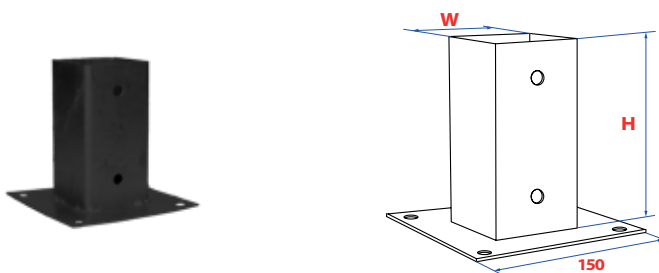

FG0321

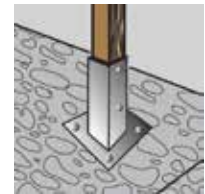

Post holder with anchor plate
Paalhouder op plaat

Pied de poteau avec patte d'ancrage
Pfostenträger mit Grundplatte

Black
Top

Art. Nr.	EAN Code	w [mm]	H [mm]	s [mm]	Hole pattern Dia. of the hole/nr. of holes	
FG03210030711505	5410439152235	71	150	2	Ø10,5/12	1
FG03210030911505	5410439152242	91	150	2	Ø10,5/12	1

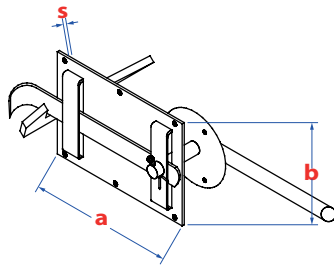

FG0341

LABELED
PER PIECE

Farmer gate latch
Boerenklinkstel met inslagnase

Fermeture à l'ancienne
Gartentorfaller mit Einschlagnase

Black
Top

Art. Nr.	EAN Code	a [mm]	b [mm]	s [mm]	Hole pattern Dia. of the hole/nr. of holes	
FG03410031200855	5410439769082	120	85	2	Ø3/4 - Ø3,6/6	10

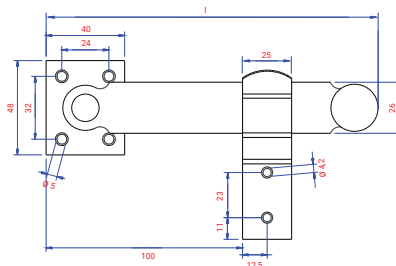

FG0345

LABELED
PER PIECE

Gate latch
Hekklank

Fermeture barrière
Gartentorfaller

Black
Top

Art. Nr.	EAN Code	l [mm]	Hole pattern Dia. of the hole/nr. of holes	
FG03450031605	5410439589123	160	Ø4,6/6	10

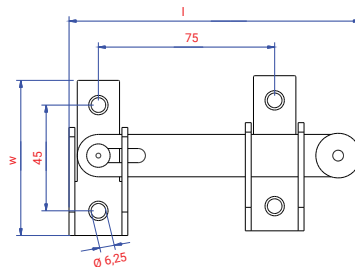

FG0348

LABELED
PER PIECE

Kick-over latch
Luikoverslag

Fermeture de volet
Schlagladenüberwurf

Black
Top

Art. Nr.	EAN Code	w [mm]	l [mm]	
FG03480030601305	5410439367776	66	124	1

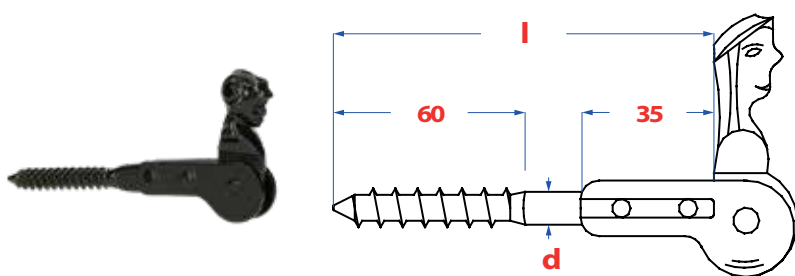

FG0349



Shutter catch "shepherdress" wood thread
Herderinnekopje met houtdraad

Arrêt tête bergère à vis à bois
Fensterlade-Feststeller mit Holzgewinde

Black
Top

Art. Nr.	EAN Code	d [mm]	l [mm]	
FG0349003101155	5410439393164	10	115	10

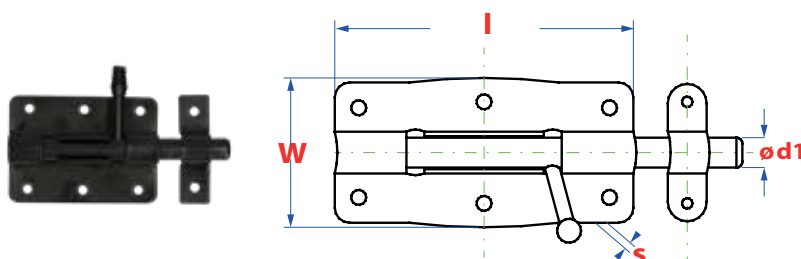

FG0353



Slide bolt
Plaatgrendel

Verrou à glissière
Grendelriegel

Black
Top

Art. Nr.	EAN Code	w [mm]	l [mm]	s [mm]	d1 [mm]	Hole pattern Dia. of the hole/nr. of holes	
FG03530030000655	5410439425209	65	50	1	10	-	12
FG03530030000805	5410439389266	80	55	1,25	12	-	12
FG03530030000905	5410439589208	90	65	1,5	14	-	12
FG03530030001005	5410439389310	100	50	-	-	Ø5,3/6 - Ø5,3/4	12

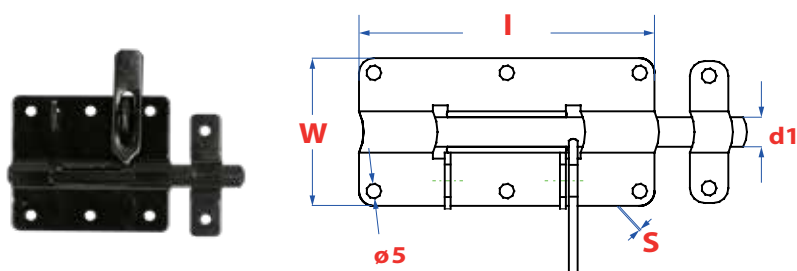

FG0355



Slide bolt for padlock
Hangslotgrendel

Verrou à porte-cadenas
Grendelriegel - abschliessbar

Black
Top

Art. Nr.	EAN Code	w [mm]	l [mm]	s [mm]	d1 [mm]	Hole pattern Dia. of the hole/nr. of holes	
FG03550030700805	5410439389419	70	80	1,5	Ø12	Ø5/8	10
FG03550030850905	5410439389402	85	90	-	-	Ø5/8	10

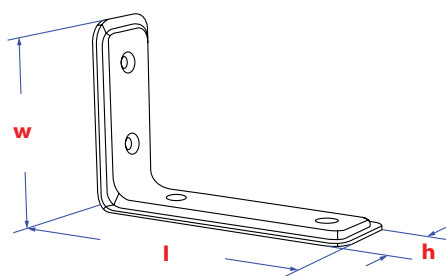

FG0381



Shelf bracket without support
Plankendrager zonder steun

Console sans support
Konsole ungestützt

Black
Top

Art. Nr.	EAN Code	w [mm]	l [mm]	h [mm]	
FG03810031150805	5410439273145	115	80	40	10
FG03810031601055	5410439273169	160	105	40	10
FG03810032351605	5410439273176	235	160	40	10
FG03810033152005	5410439273183	315	200	40	6

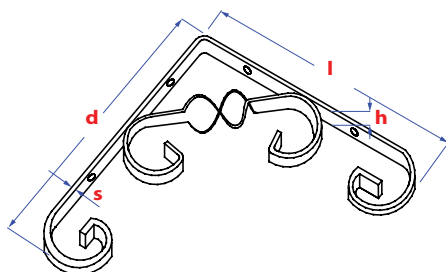

FG0384



Ornamental shelf bracket
Ornamentale plankendrager

Console ornamental
Konsole ornamental

Black
Top

Art. Nr.	EAN Code	d [mm]	l [mm]	s [mm]	h [mm]	Hole pattern Dia. of the hole/nr. of holes	
FG03840031001005	5410439273343	100	100	3	16	Ø5/5	10
FG03840031501505	5410439273350	150	150	3	13	Ø5/5	10
FG03840032002005	5410439273367	200	200	3	13	Ø5/5	10
FG03840032502505	5410439273374	250	250	3	13	Ø5/5	10

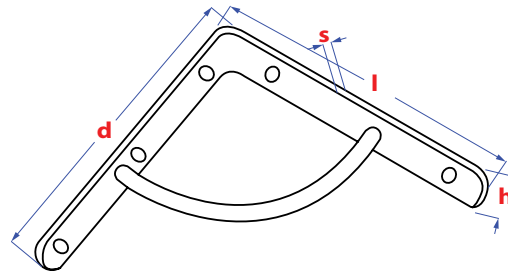

FG0385

Labeled
per pieceShelf bracket
PlankendragerConsole
KonsoleBlack
Top

Art. Nr.	EAN Code	d [mm]	l [mm]	s [mm]	h [mm]	
FG03850031401405	5410439273435	140	140	3	20	10
FG03850031901905	5410439273428	190	190	5	20	10
FG03850032402405	5410439273411	240	240	5	20	10



Wood connectors

Houtverbindingen

Connecteurs bois

Holzverbindungen





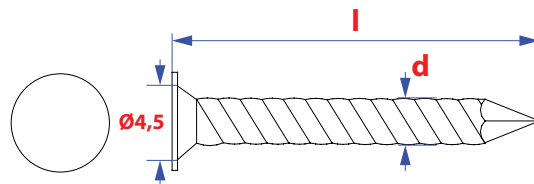



FG0100



Screw nails - Flat conical head
Schroefnagel - Ronde platte kop

Pointes torsadées - Tête plate conique
Schraubennagel - Flachkopf-kegel



Art. Nr.	EAN Code	d [mm]	l [mm]		
FG0100001380325	5410439341783	3,8	32	200	
FG0100001380605	5410439341790	3,8	60	200	15

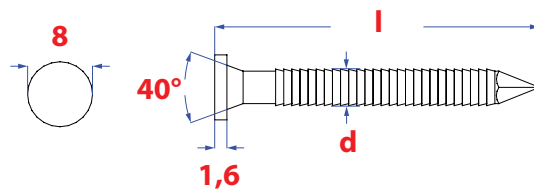



FG0101



Barbed nails
Ringnagels

Pointes annelées
Rillennägel



Art. Nr.	EAN Code	d [mm]	l [mm]		
FG0101001400405	5410439343350	4	40	200	24
FG0101001400505	5410439343367	4	50	200	15
FG0101001400605	5410439343374	4	60	200	15

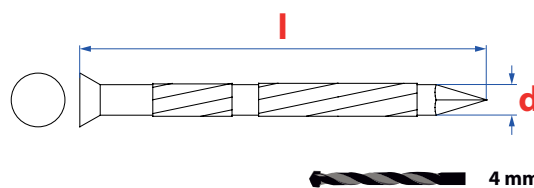

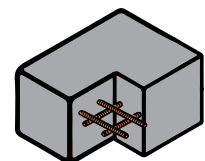

FG0102



Clamp nails
Klisjesnagel

Pointes pour tasseaux
Klisjesnagel



Art. Nr.	EAN Code	d [mm]	l [mm]	Drill ϕ [mm]		
FG0102001450405	5410439344241	4,5	40	4	125	30
FG0102001450505	5410439344258	4,5	50	4	125	30

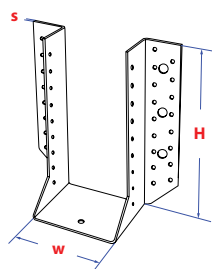

FG0121



DoPn° FG121001

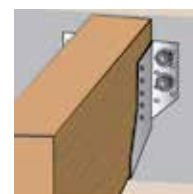

Joist hanger - Type A exterior lips
Zware balkendrager - Type A uitwendige lippen

Support poutre - Type A ailes extérieures
Balkenschuh - Typ A aussen abgewinkelt



Art. Nr.	EAN Code	w [mm]	H [mm]	s [mm]	Hole pattern Dia. of the hole/nr. of holes	
FG01210010251175	5410439336963	25	117	2	Ø5/22 - Ø7/1 - Ø11/4	10
FG01210010321145	5410439336994	32	114	2	Ø5/22 - Ø7/1 - Ø11/4	10
FG01210010401105	5410439322799	40	110	2	Ø5/22 - Ø7/1 - Ø11/4	10
FG01210010401485	5410439359917	40	148	2	Ø5/28 - Ø7/1 - Ø9/4 - Ø13/4	10
FG01210010461025	5410439385343	46	102	2	Ø5/18 - Ø7/1 - Ø11/4	10
FG01210010461445	5410439390514	46	144	2	Ø5/30 - Ø7/1 - Ø9/4 - Ø14/4	10
FG01210010501055	5410439322812	50	105	2	Ø5/22 - Ø7/1 - Ø11/4	10
FG01210010501435	5410439359870	50	143	2	Ø5/30 - Ø7/1 - Ø9/4 - Ø14/4	10
FG01210010591005	5410439322836	59	100	2	Ø5/28 - Ø7/1 - Ø11/4	10
FG01210010591605	5410439322850	59	160	2	Ø5/34 - Ø7/1 - Ø9/4 - Ø13/4	10
FG01210010591905	5410439337021	59	190	2	Ø5/40 - Ø7/1 - Ø11/4	10
FG01210010630985	5410439322874	63	98	2	Ø5/22 - Ø7/1 - Ø11/4	10
FG01210010631285	5410439322898	63	128	2	Ø5/28 - Ø7/1 - Ø11/4	10
FG01210010631585	5410439322911	63	158	2	Ø5/34 - Ø7/1 - Ø11/4	10
FG01210010631885	5410439337052	63	188	2	Ø5/44 - Ø7/1 - Ø9/4 - Ø13/6	10
FG01210010710955	5410439337083	71	95	2	Ø5/22 - Ø7/1 - Ø11/4	10
FG01210010711255	5410439337113	71	125	2	Ø5/28 - Ø7/1 - Ø11/4	10
FG01210010711545	5410439337144	71	154	2	Ø5/34 - Ø7/1 - Ø9/4 - Ø13/4	10
FG01210010711845	5410439337175	71	184	2	Ø5/22 - Ø7/1 - Ø11/4	10
FG01210010751225	5410439322935	75	122	2	Ø5/28 - Ø7/1 - Ø11/4	10
FG01210010751525	5410439322959	75	152	2	Ø5/34 - Ø7/1 - Ø11/4	10
FG01210010751825	5410439322973	75	182	2	Ø5/22 - Ø7/1 - Ø11/4	10
FG01210010752125	5410439322997	75	212	2	Ø5/22 - Ø7/1 - Ø11/4	10
FG01210011001405	5410439337205	100	140	2	Ø5/22 - Ø7/1 - Ø11/4	10
FG01210011002005	5410439034982	100	200	2	-	10
FG01210011201605	5410439337236	120	160	2	Ø5/22 - Ø7/1 - Ø11/4	10

TYPE 260

Holes : $\varnothing 5 \times 22 - 7 \times 1 - 11 \times 4$

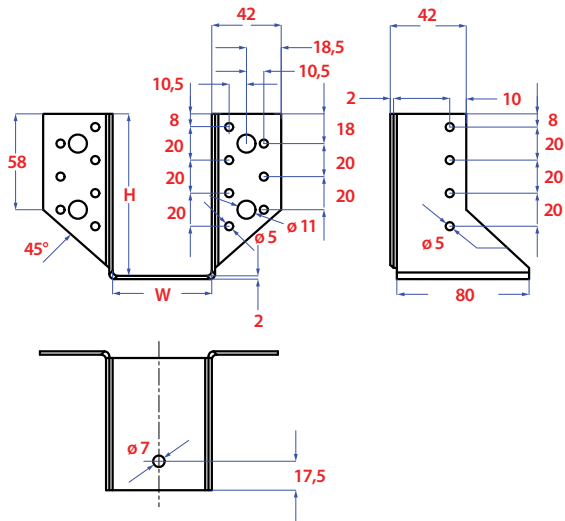

TYPE 320

Holes : $\varnothing 5 \times 28 - 7 \times 1 - 11 \times 4$

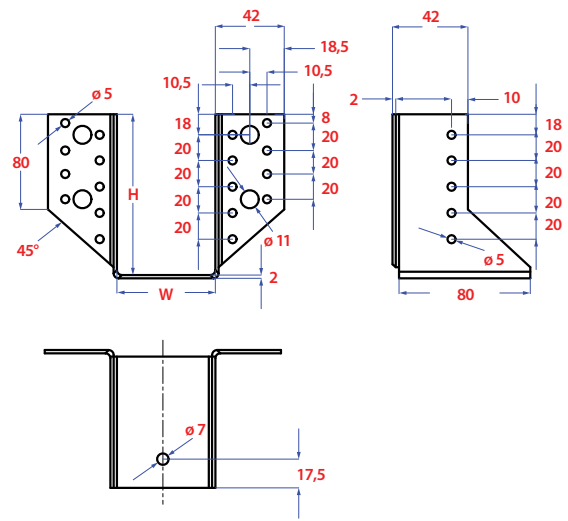

TYPE 380

Holes : $\varnothing 5 \times 35 - 7 \times 1 - 11 \times 4$

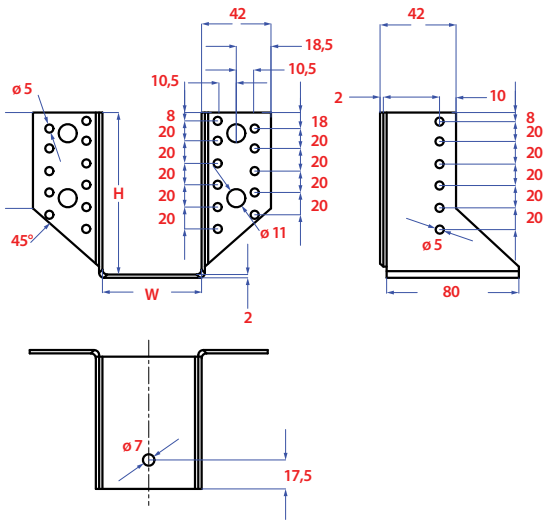

TYPE 440

Holes : $\varnothing 5 \times 40 - 7 \times 1 - 11 \times 4$

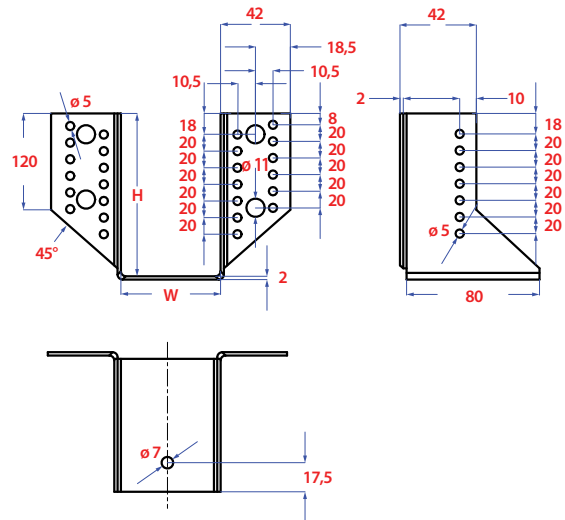

TYPE 500

Holes : $\varnothing 5 \times 48 - 7 \times 1 - 11 \times 6$

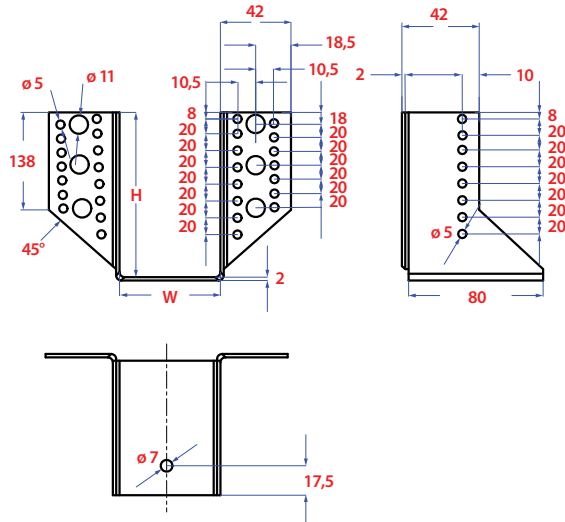

Fixings - Bevestigingen

Fixations - Befestigungen



TYPE : PFETTG + PFABST



TYPE : DIN 571



TYPE : SM07TB

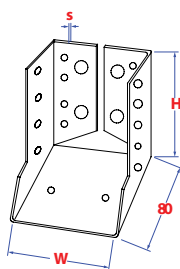

FG0122



DoPn° FG122001



Joist hanger - Inner folded
Zware balkendrager inwendige lippen

Support poutre à ailes intérieures
Balkenschuh nach innen abgewinkelt



Art. Nr.	EAN Code	w [mm]	H [mm]	s [mm]	Hole pattern Dia. of the hole/nr. of holes	
FG01220010601005	5410439343206	60	100	2	Ø5/8 - Ø13/4 - Ø5/8	25
FG01220010601305	5410439109604	60	130	2	Ø5/8 - Ø13/4 - Ø5/8	10
FG01220010701255	5410439110419	70	125	2	Ø5/18 - Ø13/4 - Ø5/10	20
FG01220010701555	5410439110426	70	155	2	Ø5/18 - Ø13/4 - Ø5/10	20
FG01220010801205	5410439343220	80	120	2	Ø5/18 - Ø13/4 - Ø5/10	20
FG01220010801505	5410439109628	80	150	2	Ø5/18 - Ø13/4 - Ø5/10	10
FG01220010801805	5410439109642	80	180	2	Ø5/18 - Ø13/4 - Ø5/10	10

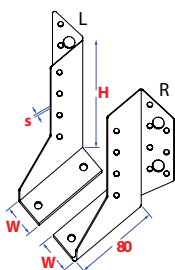

FG0123



Joist hanger - 2-parts (left + right)
Zware balkendrager - 2-delig (l + r)

Support poutre - 2 éléments (gauche + droite)
Balkenschuh - 2-teilig (links + rechts)



Art. Nr.	EAN Code	w [mm]	H [mm]	s [mm]	Hole pattern Dia. of the hole/nr. of holes	
FG01230010301005	5410439343299	30	100	2	Ø5/11 - Ø11/2	25
FG01230010301405	5410439343312	30	150	2	Ø5/17 - Ø11/2	25

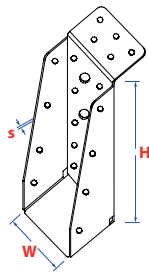

FG0126

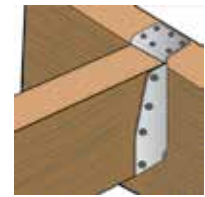

Beamsupport with long lip
Balkdrager met lange lip

Support poutre avec lèvres longue
Balkenschuh mit lange Lasche



Art. Nr.	EAN Code	w [mm]	H [mm]	s [mm]	Hole pattern Dia. of the hole/nr. of holes	
FG01260010460965	5410439646628	46	96	1,5	Ø4/14 - Ø9/3 - Ø14/1	25
FG01260010461215	5410439336611	46	121	1,5	Ø4,3/14 - Ø8,7/2 - Ø13,8/1	25
FG01260010461465	5410439336635	46	146	1,5	Ø4,3/20 - Ø8,7/2 - Ø13,8/1	25
FG01260010501255	5410439336659	50	125	1,5	Ø4,3/14 - Ø8,7/2 - Ø13,8/1	25
FG01260010501505	5410439336673	50	150	1,5	Ø4,3/20 - Ø8,7/2 - Ø13,8/1	25
FG01260010591465	5410439390491	59	146	1,5	Ø4/20 - Ø9/3 - Ø14/1	25
FG01260010591565	5410439336697	59	156	1,5	Ø4,3/20 - Ø8,7/2 - Ø13,8/1	25
FG01260010591715	5410439336710	59	171	1,5	Ø4/20 - Ø9/3 - Ø14/1	25
FG01260010631605	5410439336734	63	160	1,5	Ø4,3/20 - Ø8,7/2 - Ø13,8/1	25
FG01260010631755	5410439321808	63	175	1,5	Ø4,3/20 - Ø8,7/2 - Ø13,8/1	25
FG01260010711715	5410439336758	71	171	1,5	Ø4,3/23 - Ø8,7/2 - Ø13,8/2	25
FG01260010711965	5410439336772	71	196	1,5	Ø4,3/23 - Ø8,7/2 - Ø13,8/2	25
FG01260010712215	5410439336796	71	221	1,5	Ø4,3/27 - Ø8,7/2 - Ø13,8/2	25
FG01260010751755	5410439336819	75	175	1,5	Ø4,3/23 - Ø8,7/2 - Ø13,8/2	25
FG01260010752005	5410439336833	75	200	1,5	Ø4,3/23 - Ø8,7/2 - Ø13,8/2	25
FG01260010752255	5410439336857	75	225	1,5	Ø4,3/27 - Ø8,7/2 - Ø13,8/2	25
FG01260010961965	5410439646642	96	196	1,5	Ø4/23 - Ø9/2 - Ø14/2	20
FG01260011002505	5410439336871	100	250	1,5	Ø4/25 - Ø9/2 - Ø14/2	10

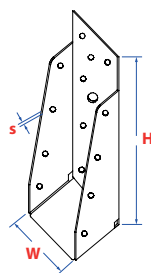

FG0128



Beamsupport without lip
Balkdrager zonder lip

Support poutre sans lèvre
Balkenschuh ohne Lasche



Art. Nr.	EAN Code	w [mm]	H [mm]	s [mm]	Hole pattern Dia. of the hole/nr. of holes	
FG01280010460965	5410439356985	46	96	1,5	Ø4/9 - Ø9/2 - Ø14/1	20
FG01280010461215	5410439355919	46	121	1,5	Ø4/11 - Ø9/2 - Ø14/1	20
FG01280010461465	5410439357005	46	146	1,5	Ø4/13 - Ø9/2 - Ø14/1	20
FG01280010501005	5410439357203	50	100	1,5	Ø4/9 - Ø9/2 - Ø14/1	20
FG01280010501505	5410439357470	50	150	1,5	Ø4/13 - Ø9/2 - Ø14/1	20
FG01280010591215	5410439357494	59	121	1,5	Ø4/12 - Ø9/2 - Ø14/1	20
FG01280010591465	5410439357524	59	146	1,5	Ø4/15 - Ø9/2 - Ø14/1	20
FG01280010591565	5410439357579	59	156	1,5	Ø4/14 - Ø9/2 - Ø14/1	20
FG01280010591715	5410439357593	59	171	1,5	Ø4/17 - Ø9/2 - Ø14/1	20
FG01280010631605	5410439357654	63	160	1,5	Ø4/14 - Ø9/2 - Ø14/1	20
FG01280010711715	5410439357685	71	171	1,5	Ø4/16 - Ø9/2 - Ø14/1	20
FG01280010711965	5410439357708	71	196	1,5	Ø4/20 - Ø9/2 - Ø14/2	20
FG01280010712215	5410439357722	71	221	1,5	Ø4/20 - Ø9/2 - Ø14/2	20
FG01280010752005	5410439355933	75	200	1,5	Ø4/20 - Ø9/2 - Ø14/2	20

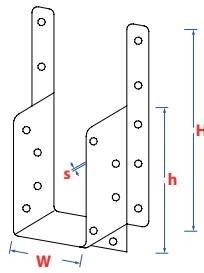

FG0136



Joist hanger with strap
Raveeldrager met strip

Support poutre à lèvres à plier
Pfettenverbinder



Art. Nr.	EAN Code	w [mm]	h [mm]	s [mm]	H [mm]	Hole pattern Dia. of the hole/nr. of holes	
FG01360010321255	5410439321648	32	125	1	190	Ø4/18	50
FG01360010321585	5410439336406	32	158	1	225	Ø3,6/22	50
FG01360010381215	5410439321662	38	121	1	190	Ø3,6/20	50
FG01360010381555	5410439336420	38	155	1	225	Ø3,6/22	50
FG01360010461175	5410439321686	46	117	1	190	Ø3,6/20	50
FG01360010461535	5410439336444	46	153	1	225	Ø3,6/22	25
FG01360010501155	5410439336475	50	115	1	190	Ø3,6/20	25
FG01360010501505	5410439336499	50	150	1	225	Ø3,6/22	50
FG01360010591105	5410439336512	59	110	1	190	Ø3,6/20	25
FG01360010591535	5410439336536	59	153	1	225	Ø3,6/22	25
FG01360010631555	5410439336574	63	155	1	225	Ø3,6/22	50
FG01360010711525	5410439646680	71	152	1	225	Ø3,6/22	50
FG01360010751495	5410439336598	75	149	1	305	Ø4/30	50

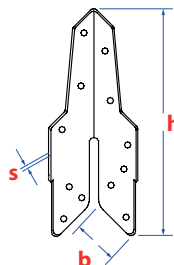

FG0141



Universal coner joint
Universeel hoek gripanker

Patte-equerre d'ancrage universel
Eckverbinder universal



Art. Nr.	EAN Code	b [mm]	h [mm]	s [mm]	Hole pattern Dia. of the hole/nr. of holes	
FG01410010000055	5410439341745	35	125	1,2	Ø3,7/12	50

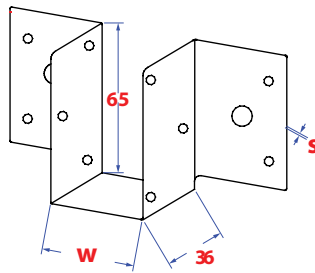

FG0142

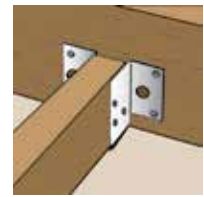

Light joist hanger - Type U
Regeldrager - Type U

Support poutre - Type U
Balkenschuh - Typ U



Art. Nr.	EAN Code	w [mm]	s [mm]	Hole pattern Dia. of the hole/nr. of holes	
FG01420010000255	5410439321709	25	1	Ø3,6/10 - Ø6,2/2	10
FG01420010000325	5410439321723	32	1	Ø4/12 - Ø9/2	10
FG01420010000385	5410439321747	38	1	Ø3,6/10 - Ø6,2/2	10
FG01420010000465	5410439321761	46	1	Ø3,6/10 - Ø6,2/2	10
FG01420010000505	5410439321785	50	1	Ø3,6/10 - Ø6,2/2	10
FG01420010000595	5410439390484	59	1	Ø3,6/10 - Ø6,2/2	10
FG01420010000635	5410439359481	63	1,25	Ø3,6/10 - Ø6,2/2	10

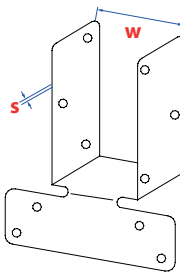

FG0144

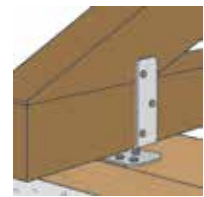

Truss clip - vertical
Trussclip - verticaal

Pied de fermette - Verticalement
Balkenverbinder - Vertikal



Art. Nr.	EAN Code	w [mm]	s [mm]	Hole pattern Dia. of the hole/nr. of holes	
FG01440010000465	5410439342278	46	1,25	Ø3,6/10	25
FG01440010000505	5410439342292	50	1,25	Ø3,6/10	25
FG01440010000595	5410439342315	59	1,25	Ø4/10	25



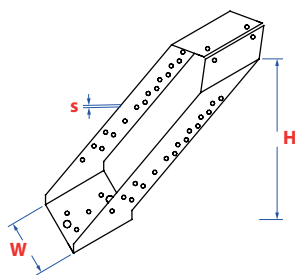

Purlin joint
Gordinglas

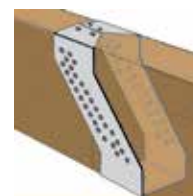

Cantilever
Balkenverbinder

FG0151



Art. Nr.	EAN Code	w [mm]	H [mm]	s [mm]	Hole pattern Dia. of the hole/nr. of holes	
FG01510010631755	5410439341806	63	175	1,5	Ø4/41 - Ø8/2	10
FG01510010752005	5410439341813	75	200	1,5	Ø4/49 - Ø8/2	10



Roof ridge fixing - left + right
Verbindingshoek - links + rechts

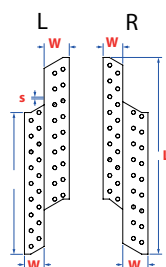

Pattes de solivage - gauche + droite
Sparrenpfettenanker - Links + Rechts

FG0153

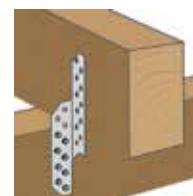

DoPh® FG153001



Art. Nr.	EAN Code	w [mm]	L [mm]	s [mm]	Hole pattern Dia. of the hole/nr. of holes	
FG015300132170L5	5410439342889	32	170	2	Ø5/20	100
FG015300132170R5	5410439342865	32	170	2	Ø5/20	100
FG015300132210L5	5410439342926	32	210	2	Ø5/28	100
FG015300132210R5	5410439342902	32	210	2	Ø5/28	100
FG015300132250L5	5410439342933	32	250	2	Ø5/20	100
FG015300132250R5	5410439342957	32	250	2	Ø5/32	100
FG015300132290L5	5410439390682	32	290	2	-	100
FG015300132290R5	5410439390705	32	290	2	-	100

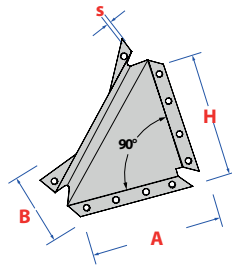

FG0154



Chocks
Gordingklos

Echantignoles
Knaggen

Art. Nr.	EAN Code	A [mm]	B [mm]	s [mm]	h [mm]	Hole pattern Dia. of the hole/nr. of holes	
FG01540010900755	5410439345699	90	75	2	90	Ø5/16	20
FG01540011300755	5410439345712	130	75	2	130	Ø5/20	20

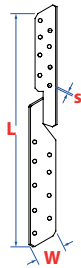

FG0155



DoPh® FG155001



Roof ridge fixing - Type A
Hoekverbinder - Type A

Patte de solivage - Type A
Sparrenpfettenanker - Typ A

Art. Nr.	EAN Code	w [mm]	l [mm]	s [mm]	
FG01550010351705	5410439361521	35	170	2	100

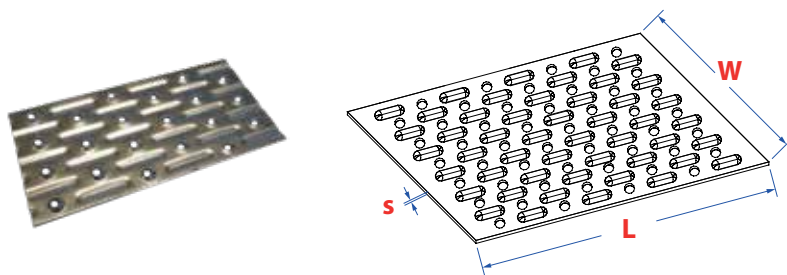

FG0156

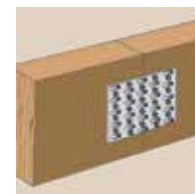

Nailing gusset
Spijkerplaat

Plaque à clouer
Lochplatte



Art. Nr.	EAN Code	w [mm]	L [mm]	s [mm]	Hole pattern Dia. of the hole/nr. of holes	
FG01560010750505	5410439359566	75	50	1,25	-	100
FG01560010751005	5410439027168	75	100	1	Ø3,6/21	100
FG01560010752005	5410439337298	75	200	1	-	50
FG01560010752505	5410439337311	75	250	1,25	Ø3,6/35	50
FG01560010753005	5410439337335	75	300	1,25	Ø3,6/42	25
FG01560011060505	5410439337373	106	50	1,25	-	100
FG01560011061005	5410439337366	106	100	1,25	-	50
FG01560011061505	5410439337359	106	150	1,25	-	50
FG01560011062005	5410439321587	106	200	1,25	Ø3,6 /40	25
FG01560011062505	5410439337342	106	250	1,25	Ø3,6/50	25

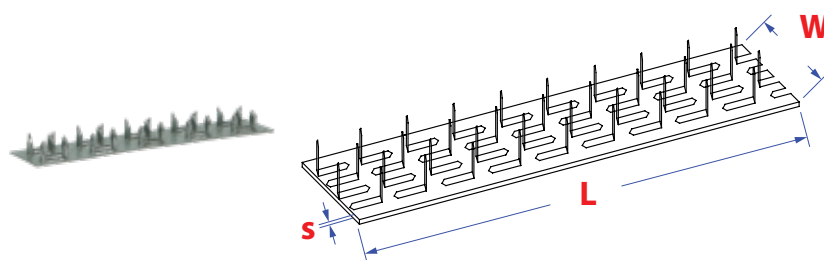

FG0158

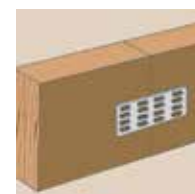

Multinailing gusset
Multi-nagelplaat

Platine à clous
Nagelplatte



Art. Nr.	EAN Code	w [mm]	L [mm]	s [mm]	
FG01580010250995	5410439321600	25	99	1	50
FG01580010251305	5410439321624	25	130	1	50
FG01580010252005	5410439336345	25	200	1	50
FG01580010761295	5410439336376	76	129	1	50

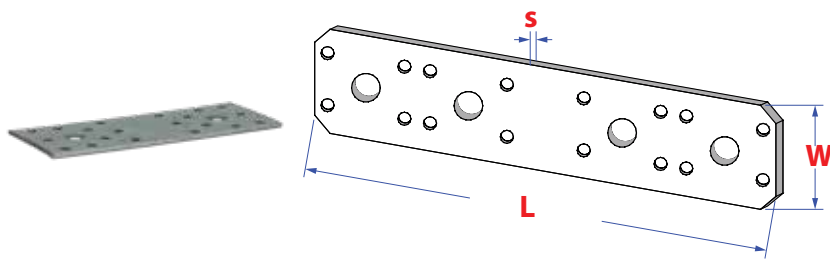

FG0159

Labeled
per piece

DoPn° FG159001

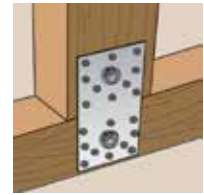

Flat connector - Heavy type
Koppelplaat - Zwaar type

Platinne d'assemblage - Type lourde
Flachverbinder - schwer



Art. Nr.	EAN Code	w [mm]	L [mm]	s [mm]	Hole pattern Dia. of the hole/nr. of holes	
FG01590010401005	5410439322195	35	95	3	Ø5/8 - Ø11/2	100
FG01590010401805	5410439322232	40	180	3	Ø5/16 - Ø11/4	50
FG01590010551405	5410439322218	55	135	2,5	Ø5/20 - Ø13/2	50
FG01590010651765	5410439322256	65	176	3	Ø5/20 - Ø13/2	50
FG01590010901955	5410439322270	90	200	3	Ø5/32 - Ø13/4	50

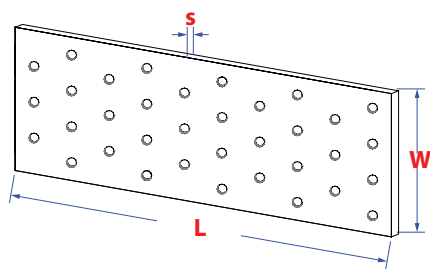

FG0160



DoPn° FG160001

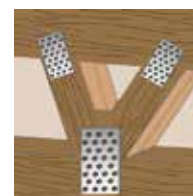

Anchor plate
Verbindingsplaat

Platine d'assemblage
Lochplatten



Art. Nr.	EAN Code	w [mm]	L [mm]	s [mm]	Hole pattern Dia. of the hole/nr. of holes	
FG01600010400605	5410439322294	40	60	2	Ø5/6	200
FG01600010400805	5410439359580	40	80	2	Ø5/8	100
FG01600010401005	5410439359603	40	100	2	Ø5/10	100
FG01600010401205	5410439322317	40	120	2	Ø5/12	100
FG01600010401605	5410439363068	40	160	2	Ø5/16	100
FG01600010402005	5410439363075	40	200	2	Ø5/20	100
FG01600010402405	5410439322331	40	240	2	Ø5/23	100
FG01600010601405	5410439322355	60	140	2	Ø5/21	50
FG01600010601605	5410439113762	60	160	2	Ø5/21	50
FG01600010602005	5410439322379	60	200	2	Ø5/30	50
FG01600010602405	5410439322393	60	240	2	Ø5/36	50
FG01600010802005	5410439322416	80	200	2	Ø5/40	50
FG01600010802405	5410439322430	80	240	2	Ø5/48	50
FG01600010803005	5410439359641	80	300	2	Ø5/60	25
FG01600011001405	5410439363082	100	140	2	Ø5/35	50
FG01600011002005	5410439359665	100	200	2	Ø5/50	25
FG01600011002405	5410439359689	100	240	2	Ø5/60	25
FG01600011003005	5410439363792	100	300	2	Ø5/75	25

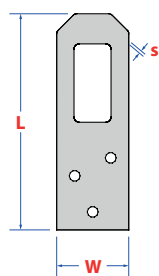

FG0161



LABELED
PER PIECE

Coat rack plate
Kapstok ophangoog

Platine porte-manteau
Rahmenöse



Art. Nr.	EAN Code	w [mm]	L [mm]	s [mm]	
FG01610010200305	5410439337724	20	30	1,25	50
FG01610010200505	5410439337748	20	50	1,25	50
FG01610010200605	5410439337762	20	60	1,25	50

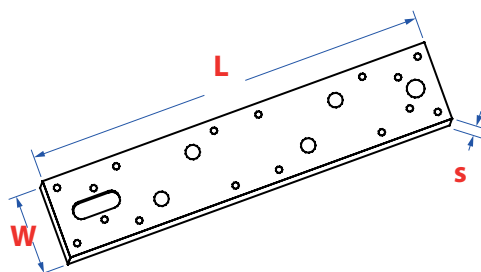

FG0162



LABELED
PER PIECE



Fish plate
Koppelplaat

Plaque d'assemblage
Flachverbinder



Art. Nr.	EAN Code	w [mm]	L [mm]	s [mm]	Hole pattern Dia. of the hole/nr. of holes	
FG01620010462505	5410439360739	46	250	2,5	4,5/10-6,5/6-19,5/1-20X10,5/1	50
FG01620010552505	5410439360753	60	240	2,5	Ø4/12 - Ø6/8 - Ø11/2	50

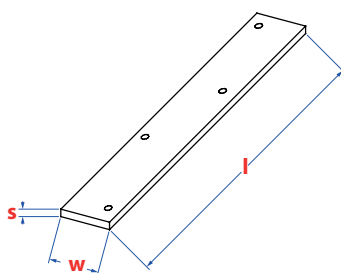

FG0163



LABELED
PER PIECE

Strap anchor
Koppelanker

Ancrage d'accouplement
Flachverbinder



Art. Nr.	EAN Code	w [mm]	l [mm]	s [mm]	Hole pattern Dia. of the hole/nr. of holes	
FG01630010303005	5410439623957	30	300	5	Ø4/7	25
FG01630010304005	5410439623971	30	400	5	Ø6/7	25

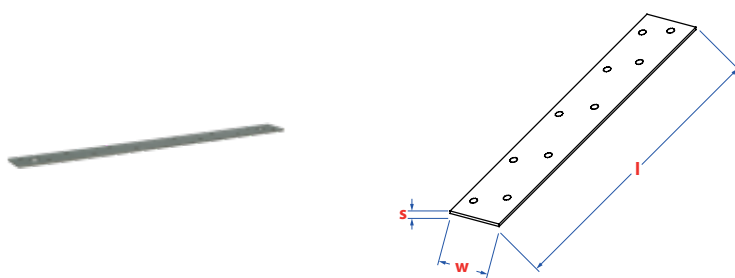



FG0164

LABELED
PER PIECEStrap anchor
KoppelankerAncrage d'accouplement
Flachverbinder

Art. Nr.	EAN Code	w [mm]	l [mm]	s [mm]	Hole pattern Dia. of the hole/nr. of holes	
FG01640010303005	5410439632263	30	300	2	Ø3,7/8	25
FG01640010304005	5410439632287	30	400	2	Ø4/12 - Ø9/2	25

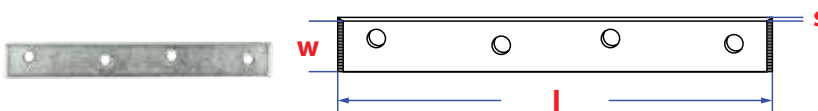
FG0166

Connector - Narrow type
Verbindingsplaat - Smal typePlatine de connection - Type étroite
Verbindungsplatte - schmal

Art. Nr.	EAN Code	w [mm]	l [mm]	s [mm]	Hole pattern Dia. of the hole/nr. of holes		
FG01660010150502	5410439108720	15	50	2	Ø4/4	20	50
FG01660010150503	5410439108744	15	50	2	Ø4/4	8	200
FG01660010150702	5410439108751	15	80	2	Ø4/4	20	30
FG01660010150703	5410439108782	15	70	2	Ø4/4	8	80
FG01660010161002	5410439108799	16	100	2	Ø4/4	20	40
FG01660010161003	5410439108812	16	100	2	Ø4/4	8	100
FG01660010161252	5410439108676	16	120	2	Ø4/4	20	25
FG01660010181502	5410439108836	18	150	2	Ø5/4	20	20
FG01660010181503	5410439108850	18	150	2	Ø5/4	8	40

FG0166

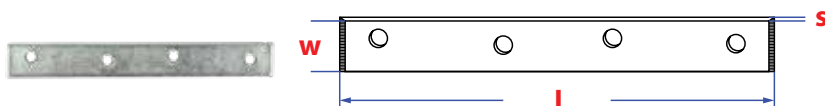

Connector - Narrow type
Verbindingsplaat - Smal type

Platine de connection - Type étroite
Verbindungsplatte - schmal



Art. Nr.	EAN Code	w [mm]	l [mm]	s [mm]	Hole pattern Dia. of the hole/nr. of holes	
FG01660010150505	5410439322119	15	50	2	Ø4/4	100
FG01660010150705	5410439322133	15	80	2	Ø4/4	100
FG01660010161005	5410439322157	16	100	2	Ø4/4	50
FG01660010161255	5410439322171	18	120	2	Ø4/4	50
FG01660010181505	5410439336901	18	150	2	Ø5/4	50
FG01660010181755	5410439336925	18	175	2,5	Ø5/4	50
FG01660010192005	5410439336949	19	200	2,5	Ø5/4	50

FG0166

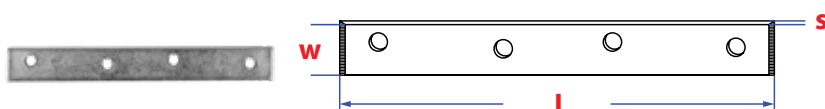

Connector - Narrow type
Verbindingsplaat - Smal type

Platine de connection - Type étroite
Verbindungsplatte - schmal



Art. Nr.	EAN Code	w [mm]	l [mm]	s [mm]	Hole pattern Dia. of the hole/nr. of holes	
FG0166A000150755	5410439016384	15	75	2	Ø4,5/4	50
FG0166A000151005	5410439016414	15	100	2	Ø4,5/4	50
FG0166A000181205	5410439016438	18	120	2	Ø5,5/4	50

FG0168

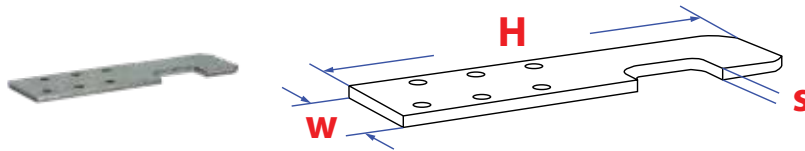

DoPh° FG168001



T-anchor plate - Connecting IPN/wood
Verbindingsplaat - IPN/hout

Ancrages IPN - Liaison IPN/bois
HE-anker T-Träger/Holz balken



Art. Nr.	EAN Code	w [mm]	H [mm]	s [mm]	Hole pattern Dia. of the hole/nr. of holes	
FG01680010401355	5410439343152	40	135	4	Ø5/6	100
FG01680010401755	5410439343176	40	175	4	Ø5/10 - Ø13/2	50

FG0169

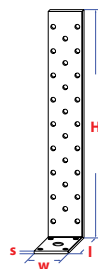

DoPh° FG169001

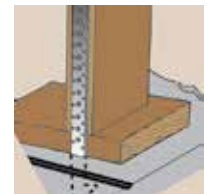

Anchor square
Betonanker

Equerre d'ancrage à sceller
Betonflachstahlanker



Art. Nr.	EAN Code	w [mm]	H [mm]	s [mm]	l [mm]	Hole pattern Dia. of the hole/nr. of holes	
FG01690010402005	5410439342780	40	206	2	42	Ø5/19 - Ø13/1	25
FG01690010403005	5410439342803	40	307	2	42	Ø5/27 - Ø13/1	25
FG01690010404005	5410439342827	40	407	2	42	Ø5/34 - Ø13/1	25

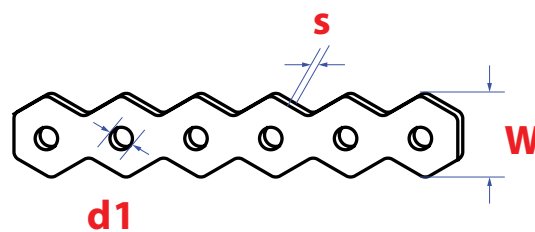

FG0170



Corrugated assembly belt/plastic box
Gegolfde gaatjesband in cassette

Bande perfo ondulée en cassette
Windrispenband gewellt in Kasette



Art. Nr.	EAN Code	w [mm]	l [m]	s [mm]	d1 [mm]	Hole pattern Dia. of the hole/nr. of holes	
FG017000112085	5410439343404	12	10	0,8	5	Ø5	10
FG017000117085	5410439343411	17	10	0,8	7	Ø3 - Ø6,3	10
FG017000126105	5410439343435	26	10	1	8,5	Ø8,5	10

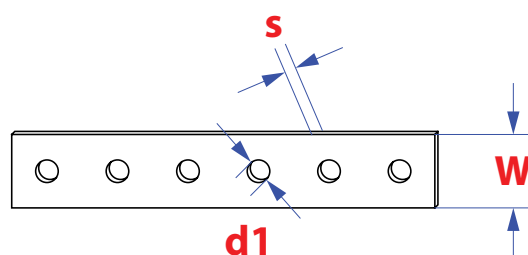
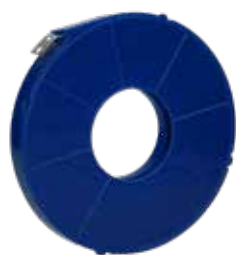

FG0171



Straight assembly belt/plastic box
Rechte gaatjesband in cassette

Bande perfo droite en cassette
Windrispenband recht in Kasette

10m



Art. Nr.	EAN Code	w [mm]	l [m]	s [mm]	d1 [mm]	Hole pattern Dia. of the hole/nr. of holes	
FG017100112085	5410439343466	12	10	0,8	5,3	Ø5,2	10
FG017100117085	5410439343480	17	10	0,8	6,5	Ø6,5	10
FG017100125105	5410439343503	25	10	1	8,5	Ø8,5	5

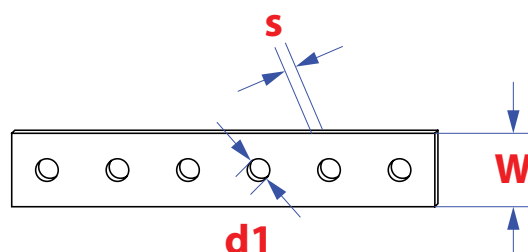
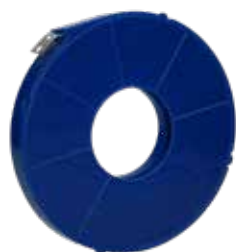

FG0171



Straight assembly belt/plastic box
Rechte gaatjesband in cassette

Bande perfo droite en cassette
Windrispenband recht in Kasette

10m



Art. Nr.	EAN Code	w [mm]	l [m]	s [mm]	d1 [mm]	Hole pattern Dia. of the hole/nr. of holes	
FG0171A0012085	5410439343541	12	10	0,8	5,3	Ø5,2	10
FG0171A0017085	5410439343527	17	10	0,8	6,5	Ø6,5	10

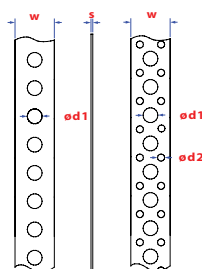

FG0172



Straight assembly belt
Rechte gaatjesband

Bande perforée droite
Windrispenband recht

10m



Art. Nr.	EAN Code	w [mm]	l [m]	s [mm]	d1 [mm]	d2 [mm]	Hole pattern Dia. of the hole/nr. of holes	
FG017200112085	5410439337267	12	10	0,8	5,2	-	Ø5,2	10
FG017200117085	5410439211949	17	10	0,8	6,5	3	Ø3 - Ø6,5	10
FG017200125105	5410439211956	25	10	1	8,5	4	Ø4 - Ø8,5	10

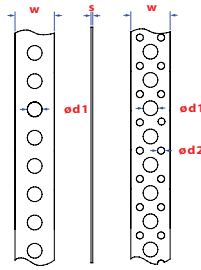

FG0172



Straight assembly belt, plasticized
Rechte gaatjesband, geplastificeerd

Bande perforée droite, plastifié
Windrispenband recht, plastificiert

10m



Art. Nr.	EAN Code	w [mm]	l [m]	s2 [mm]	s [mm]	d1 [mm]	Hole pattern Dia. of the hole/nr. of holes	
FG017207414085	5410439343626	14	10	3	0,8	5,2	Ø5,2	10
FG017207419085	5410439343664	19	10	3	0,8	6,5	Ø6,5	10
FG017207427085	5410439343688	27	10	3	0,8	8,5	Ø8,5	5

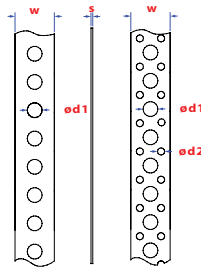

FG0172



Straight assembly belt
Rechte gaatjesband

Bande perforée droite
Windrispenband recht

6m



Art. Nr.	EAN Code	w [mm]	l [m]	s [mm]	d1 [mm]	Hole pattern Dia. of the hole/nr. of holes	
FG0172A0012085	5410439343602	12	10	0,8	5,3	Ø5,2	10
FG0172A0017085	5410439343589	17	10	0,8	6,5	Ø6,5	10
FG0172A0025085	5410439343565	25	10	0,8	8,5	Ø8,5	5

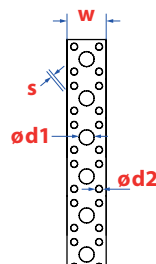

FG0173



Straight assembly belt
Rechte gaatjesband

Bande perforée droite
Windrispenband recht

25m



Art. Nr.	EAN Code	w [mm]	l [m]	s [mm]	d1 [mm]	d2 [mm]	Hole pattern Dia. of the hole/nr. of holes	
FG017300112085	5410439337281	12	25	0,8	5,3	3	Ø5,2	5
FG017300117085	5410439211970	17	25	0,8	6,5	3	Ø6,5	10
FG017300125105	5410439211987	25	25	1	8,5	3	Ø8,5	5

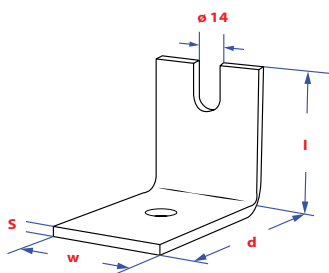

FG0174



Angled lug
Beton hoekanker

Equerre de fixation béton
Betonwinkel



Art. Nr.	EAN Code	d [mm]	l [mm]	s [mm]	w [mm]	Hole pattern Dia. of the hole/nr. of holes	
FG01740100750755	5410439352246	75	75	6	60	Ø14/1	50
FG01740100751005	5410439352260	75	100	6	60	Ø14/1	25

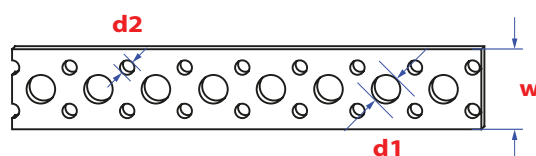

FG0175



Straight assembly belt
Rechte gaatjesband

Bande perforée droite
Windrispenband recht

5m



Art. Nr.	EAN Code	w [mm]	l [m]	s [mm]	d1 [mm]	d2 [mm]	Hole pattern Dia. of the hole/nr. of holes	
FG017500125105	5410439361545	25	5	1	8,5	3	Ø8,5	10

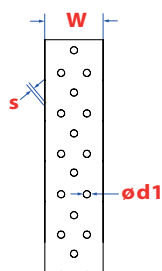

FG0178



Straight assembly belt
Rechte gaatjesband

Bande perforée droite
Windrispenband recht

50m



Art. Nr.	EAN Code	w [mm]	l [m]	s [mm]	Hole pattern Dia. of the hole/nr. of holes	
FG017800117085	5410439297189	17	50	0,8	Ø6,5	5

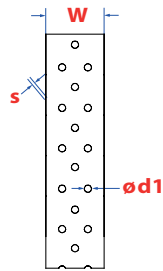

FG0178



DoPn° FG178001



Straight assembly belt
Rechte gaatjesband

Bande perforée droite
Windrispenband recht

50m

SZ
sendzimir
zinc plated

Art. Nr.	EAN Code	w [mm]	l [m]	s [mm]	d1 [mm]	Hole pattern Dia. of the hole/nr. of holes	
FG017801040205	5410439339704	40	50	2	5	Ø5	1

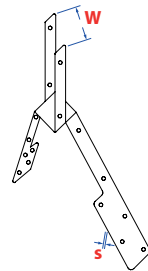

FG0179

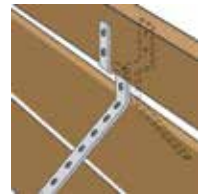

Ridge piece support
Ruitersteun

Cavalier rehausse pour charpente
Firstlattenhalter

SZ
sendzimir
zinc plated

Art. Nr.	EAN Code	w [mm]	s [mm]	Hole pattern Dia. of the hole/nr. of holes	
FG01790010000285	5410439342148	28	1,5	Ø3,4/14	50
FG01790010000325	5410439342162	32	1,5	Ø3,4/14	50

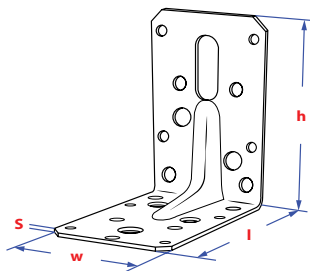

FG0185



Reinforced adjustable square
Verstelbaar hoekanker met ril

Equerre ajustable renforcée
Winkelverbinder abstelbar mit Sicke

SZ
sendzimir
zinc plated

Art. Nr.	EAN Code	w [mm]	l [mm]	s [mm]	h [mm]	Hole pattern Dia. of the hole/nr. of holes	
FG01850010600905	5410439390538	60	90	2	90	4,5/8-6/9-9/4-11/1-30X10,5/1	50
FG01850010601505	5410439390552	60	150	2,5	90	4,5/12-6,4/8-9/5-11/2-30X11/1	50

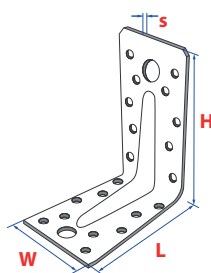

FG0186



DoPn° FG186001

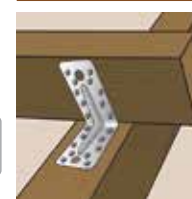

Reinforced square
Hoekanker met ril en afgeschuinde hoeken

Equerre renforcée
Winkelverbinder mit Sicke



Art. Nr.	EAN Code	w [mm]	l [mm]	s [mm]	h [mm]	Hole pattern Dia. of the hole/nr. of holes	
FG01860011251255	5410439321488	46	125	2,5	125	4,5/10-6,5/6-10,5/1-30X20/1	50
FG0186001125125555	5410439084901	55	125	2,5	125	4,5/10-6,5/6-10,5/1-30X20/1	50
FG01860011501505	5410439321501	60	150	2,5	150	4,5/20-6/4-9/4-30X11/2	50

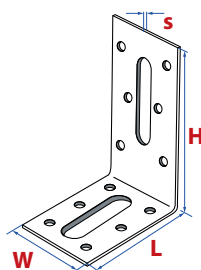

FG0187



DoPn° FG187001



Adjustable square
Verstelbaar hoekanker

Equerre ajustable
Winkelverbinder mit Kombiloch



Art. Nr.	EAN Code	w [mm]	l [mm]	s [mm]	h [mm]	Hole pattern Dia. of the hole/nr. of holes	
FG01870014612125	5410439273121	46	125	2,5	125	Ø4/10 - Ø6/6 - Ø11/1	50
FG01870016040605	5410439321525	60	40	2,5	60	4,5/12-9/2-11/1-10,5X30/1	50
FG01870016050505	5410439321549	60	50	2,5	50	Ø4,5/12 - Ø11,5X30/2	50
FG01870016090905	5410439361118	60	90	2,5	90	4,1/8-6/9-9/4-11/1-30X11/1	50
FG01870016099405	5410439390576	60	100	2,5	40	Ø4,5/12 - Ø10/1 - Ø11X30/2	50
FG01870016315155	5410439361149	60	150	2,5	150	4,5/20-6/4-9/4-30X11/2	50

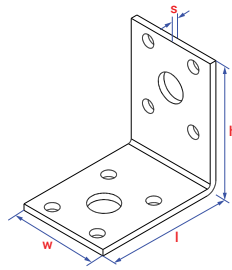

FG0188

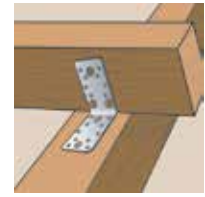
DoPh[®] FG188001

Square - Heavy type
Hoekanker - Zwaar type

Equerre - Type lourde
Winkelverbinder - schwer



Art. Nr.	EAN Code	w [mm]	l [mm]	s [mm]	h [mm]	Hole pattern Dia. of the hole/nr. of holes	
FG01880010350505	5410439322515	35	50	2,5	50	Ø5/8 - Ø10,4/2	150
FG01880010400905	5410439322553	40	90	3	90	Ø5/16 - Ø11/4	50
FG01880010550705	5410439322539	55	70	2,5	70	Ø5/12 - 11/2	50

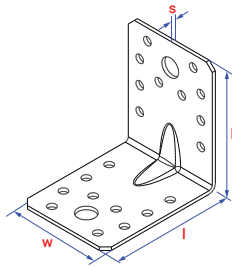

FG0189

DoPh[®] FG189001

Heavy reinforced square
Hoekanker met ril

Equerre renforcée - Type lourde
Winkelverbinder mit Verstärkungs-Sicke



Art. Nr.	EAN Code	w [mm]	l [mm]	s [mm]	h [mm]	Hole pattern Dia. of the hole/nr. of holes	
FG01890010550705	5410439359528	55	70	2,5	70	Ø5/12 - Ø11/2	50
FG01890010650905	5410439322577	65	90	2,5	90	Ø5/20 - Ø11/2	50
FG01890010901055	5410439322591	90	105	3	105	Ø5/26 - Ø11/4	25

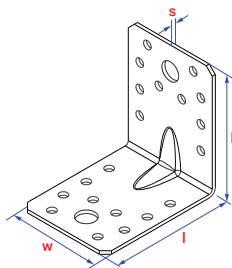

FG0189



Heavy reinforced square
Hoekanker met ril

Equerre renforcée - Type lourde
Winkelverbinder mit Verstärkungs-Sicke



Art. Nr.	EAN Code	w [mm]	l [mm]	s [mm]	h [mm]	Hole pattern Dia. of the hole/nr. of holes	
FG0189A000600905	5410439627436	60	90	2	90	Ø5/8 - Ø6/9 - Ø9/4 - Ø30X11/1	25

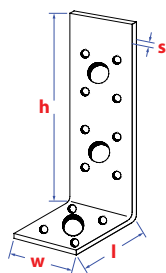

FG0190



DoPn° FG190001



Anchor square for wood/concrete
Hoekanker voor hout/beton

Equerre d'ancrage pour bois/béton
Winkelverbinder Holz/Beton



Art. Nr.	EAN Code	w [mm]	h [mm]	s [mm]	
FG01900010400905	5410439363280	40	90	2,5	100
FG01900010401605	5410439352642	40	160	3	25

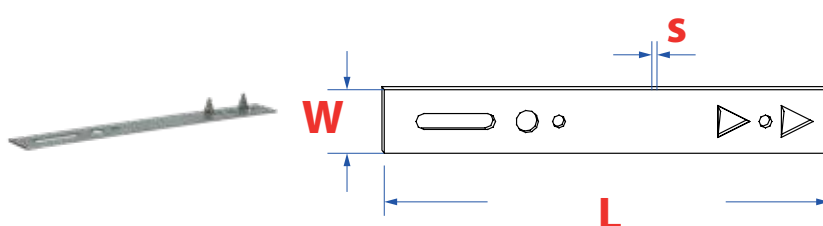

FG0206

Mounting tabs for wooden frames
Raamklauw voor houten ramen

Pattes de fixation de fenêtres bois
Montagelaschen für Holzrahmen



Art. Nr.	EAN Code	w [mm]	l [mm]	s [mm]	
FG02060010191405	5410439343725	19	140	1,25	100
FG02060010251405	5410439343749	25	140	2	100

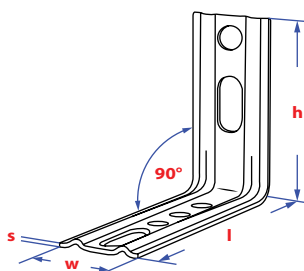

FG0210



Multi angle bracket - 90°
Kozijnhoek met ril - 90°

Equerre nervurée droite - 90°
Winkel mit Rille - 90°



Art. Nr.	EAN Code	w [mm]	l [mm]	s [mm]	Hole pattern Dia. of the hole/nr. of holes	
FG02100010300905	5410439361378	30	90	2	Ø6,4/4 - Ø8,1/1 - Ø6,5X25/2	100



Narrow square
Stoelhoek

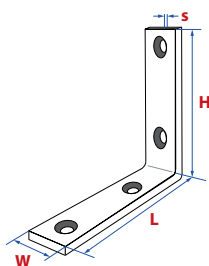



Equerre chaise
Stuhlwinkel



FG0227



Art. Nr.	EAN Code	w [mm]	l [mm]	s [mm]	Hole pattern Dia. of the hole/nr. of holes		
FG02270010140302	5410439108515	14	30	2	Ø4/4	20	50
FG02270010140303	5410439108522	14	30	2	Ø4/4	8	125
FG02270010150252	5410439114042	15	25	2	Ø4,5/4	20	40
FG02270010150402	5410439114028	15	40	2	Ø4,5/4	20	40
FG02270010160502	5410439114035	16	50	2	Ø5/4	20	30
FG02270010160652	5410439108591	16	60	2	Ø5/4	20	25
FG02270010160653	5410439108607	16	60	2	Ø5/4	8	60
FG02270010180752	5410439108621	18	70	2	Ø5,5/5	20	15
FG02270010190902	5410439108645	19	90	2	Ø5,5/6	20	12
FG02270010190903	5410439108652	19	90	2	Ø5,5/6	8	24
FG02270010191002	5410439108393	19	100	2,25	Ø5,5/6	20	10
FG02270010191003	5410439108423	19	100	2,25	Ø5,5/6	8	24
FG02270010201252	5410439108430	20	125	2,5	Ø5,5/6	20	-
FG02270010201253	5410439109307	20	125	2,5	Ø5,5/6	8	16
FG02270010251502	5410439108454	25	150	3	Ø6,5/6	20	-
FG02270010251503	5410439108478	25	150	3	Ø6,5/6	8	10



Narrow square
Stoelhoek

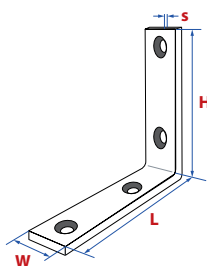

Equerre chaise
Stuhlwinkel

FG0227



Art. Nr.	EAN Code	w [mm]	l [mm]	s [mm]	h [mm]	Hole pattern Dia. of the hole/nr. of holes	
FG02270010150205	5410439015639	14	20	2	20	Ø4/2	100
FG02270010150255	5410439273046	14	25	2	25	Ø4/4	100
FG02270010150305	5410439320474	14	30	2	30	Ø4/4	100
FG02270010150405	5410439321990	15	40	2	40	Ø4,5/4	100
FG02270010160505	5410439322010	15	50	2	50	Ø5/4	100
FG02270010160655	5410439322034	16	60	2	60	Ø5/4	100
FG02270010180755	5410439322058	17,5	75	2	75	Ø5,5/5	100
FG02270010190905	5410439273060	20	90	2	90	Ø5,5/6	100
FG02270010191005	5410439322072	20	100	2,25	100	Ø5,5/6	100
FG02270010201255	5410439322096	23	125	2,5	125	Ø5,5/6	100
FG02270010251505	5410439273084	25	150	3	150	Ø6,5/6	100



Narrow square
Stoelhoek

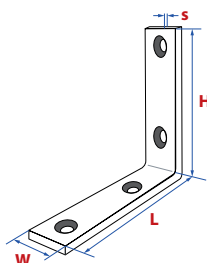

Equerre chaise
Stuhlwinkel

FG0227



Art. Nr.	EAN Code	w [mm]	l [mm]	s [mm]	h [mm]	Hole pattern Dia. of the hole/nr. of holes	
FG0227A000150255	5410439016056	15	25	1,8	25	Ø4,5/4	100
FG0227A000150405	5410439361606	15	40	2	40	Ø4,5/4	100
FG0227A000150505	5410439016049	15	50	2	50	Ø4,5/4	100
FG0227A000200605	5410439361637	20	60	2	60	Ø5/4	50
FG0227A000200805	5410439361644	20	80	2	80	Ø5,5/4	50
FG0227A000201005	5410439361651	20	100	2	100	Ø5,5/6	50



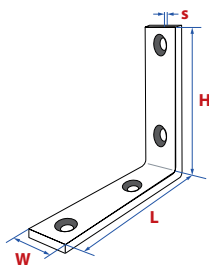

Narrow square with screws
Stoelhoek met schroeven



Equerre chaise avec vis
Stuhlwinkel mit Schrauben

FG0227



Art. Nr.	EAN Code	w [mm]	l [mm]	s [mm]	Screw size	Hole pattern Dia. of the hole/nr. of holes		
FG02270010150254	5410439110662	15	25	2	3,5 x 16	Ø4,5/4	4	300
FG02270010150404	5410439108577	15	40	2	3,5 x 16	Ø4,5/4	4	250
FG02270010160504	5410439108584	16	50	2	3,5 x 16	Ø5/4	4	150
FG02270010160654	5410439108614	16	60	2	3,5 x 16	Ø5/4	4	100
FG02270010180754	5410439108638	18	75	2	4,0 x 30	Ø5,5/5	4	80
FG02270010191004	5410439108669	19	100	2,25	4,0 x 30	Ø5,5/6	4	50
FG02270010201254	5410439109314	20	125	2,5	4,0 x 30	Ø5,5/6	4	30
FG02270710140304	5410439108546	14	30	2	3,5 x 16	Ø4/4	4	250
FG02270710150404	5410439108553	15	40	2	3,5 x 16	Ø4,5/4	4	200
FG02270710160604	5410439108560	16	60	2	3,5 x 16	Ø5/4	4	100



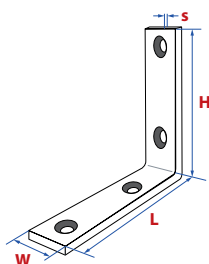

Narrow square with screws
Stoelhoek met schroeven



Equerre chaise avec vis
Stuhlwinkel mit Schrauben

FG0227



Art. Nr.	EAN Code	l [mm]	s [mm]	Screw size	Hole pattern Dia. of the hole/nr. of holes		
FG0227A000300304	5410439110914	30	1,8	3,5 x 16	Ø4/4	4	100



Narrow square - Heavy type
Dorpelhoek - Zwaar type

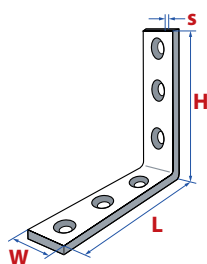

Equerre porte - Type lourde
Winkelverbinder schwer

FG0228



Art. Nr.	EAN Code	w [mm]	l [mm]	s [mm]	h [mm]	Hole pattern Dia. of the hole/nr. of holes	
FG02280010201005	5410439324243	20	100	5	100	Ø6/4	25
FG02280010201255	5410439324267	20	120	5	120	Ø6/6	25
FG02280010251505	5410439324281	20	160	5	160	Ø6/6	25
FG02280010251755	5410439324304	20	180	5	180	Ø6/6	25
FG02280010252005	5410439324328	25	200	5	200	Ø6/6	25
FG02280010302505	5410439324342	30	250	6	250	Ø6/6	25



Reinforced corner skew - 135°
Neusijzer - 135°

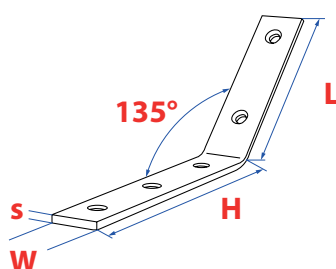

Equerre asymétrique - 135°
Winkelverbinder - 135°

FG0230



Art. Nr.	EAN Code	H [mm]	l [mm]	s [mm]	w [mm]	Hole pattern Dia. of the hole/nr. of holes	
FG02300011001505	5410439342698	100	150	5	25	Ø5,5/4	25



Merging square - 135°
Koppelplaat - 135°

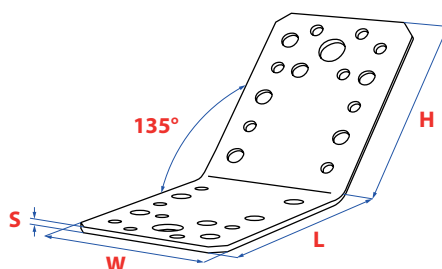

Equerre d'assemblage - 135°
Strebenverbinder - 135°

FG0231



DoPn° FG231001



Art. Nr.	EAN Code	w [mm]	l [mm]	s [mm]	h [mm]	
FG02310010650905	5410439360913	65	90	2,5	90	50

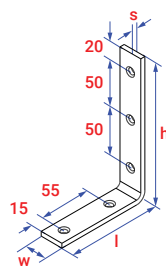

FG0233



Cornice bracket - 90°
Kroonlijsthaak - 90°

Equerre de corniche - 90°
Karniesenwinkel - 90°



Art. Nr.	EAN Code	H [mm]	l [mm]	s [mm]	w [mm]	Hole pattern Dia. of the hole/nr. of holes	
FG02330011500805	5410439269131	159	79	4,5	20	Ø5,5/4	25
FG02330011501105	5410439269148	150	100	5	25	Ø5,5/4	25

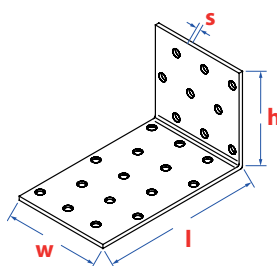

FG0235



DoPn° FG235001A

Assembly square scalene
Ongelijkbenige versterkingshoek

Equerre simple scalène
Lochplattenwinkel ungleichschenkllich



Art. Nr.	EAN Code	w [mm]	l [mm]	s [mm]	h [mm]	Hole pattern Dia. of the hole/nr. of holes	
FG02350010570755	5410439273107	57	75	2	50	Ø4/8 - Ø6/4 - Ø9/2	100
FG02350010600605	5410439344661	60	60	2,5	40	Ø5/7 - Ø5/13	100
FG02350010600805	5410439344685	60	80	2,5	60	Ø5/7 - Ø5/13	50
FG02350010601005	5410439344647	60	100	2,5	60	Ø5/7 - Ø5/13	50
FG02350010750255	5410439341554	75	25	2,5	40	Ø5,5/5	100
FG02350011150405	5410439341578	115	60	2,5	40	Ø5,5/8	20

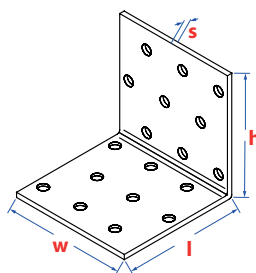

FG0236

LABELED
PER PIECE

DoPn° FG236001A



Assembly square multi holes
Versterkingshoek multigaten

Equerre multi-trous
Lochplattenwinkel



Art. Nr.	EAN Code	w [mm]	l [mm]	s [mm]	h [mm]	Hole pattern Dia. of the hole/nr. of holes	
FG02360010200405	5410439322454	20	40	2	40	Ø5/4	200
FG02360010300305	5410439360838	30	30	2	30	Ø7/4	100
FG02360010400405	5410439322478	40	40	2	40	Ø5/6	100
FG02360010400505	5410439322492	40	50	2	50	Ø5/12	100
FG02360010400605	5410439322638	40	60	2	60	Ø5/10	100
FG02360010500605	5410439322652	50	60	2	60	Ø5/12	50
FG02360010600605	5410439322676	60	60	2	60	Ø5/16	50
FG02360011000405	5410439360517	100	40	2	40		10
FG02360012000405	5410439360852	200	40	2	40		50

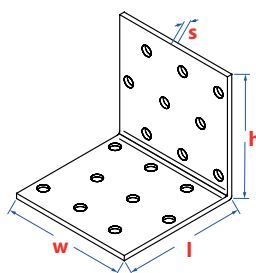

FG0236

LABELED
PER PIECE

Assembly square multi holes
Versterkingshoek multigaten

Equerre multi-trous
Lochplattenwinkel



Art. Nr.	EAN Code	w [mm]	l [mm]	s [mm]	h [mm]	Hole pattern Dia. of the hole/nr. of holes	
FG0236A000300305	5410439375252	30	30	2	25	Ø5/4	50
FG0236A000400405	5410439361774	40	40	2	40	Ø5/6	50
FG0236A000400505	5410439361750	40	50	2	50	Ø5/12	50
FG0236A000400605	5410439361699	40	60	2	60	Ø5/12	50
FG0236A000600405	5410439361736	60	40	2	40	Ø5/6	50
FG0236A000600605	5410439361712	60	60	2	60	Ø5/18	50

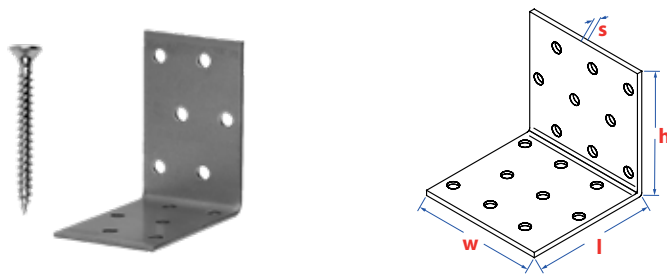

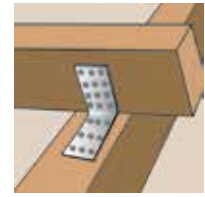

FG0236



Assembly square multi holes with screws
Versterkingshoek multigaten met schroeven

Equerre multi-trous avec vis
Lochplattenwinkel mit Schrauben



Art. Nr.	EAN Code	w [mm]	l [mm]	s [mm]	h [mm]	Screw size	Hole pattern Dia. of the hole/nr. of holes		
FG0236A000150404	5410439108898	40	40	2	15	4,0 x 16	Ø5/4	4	200
FG0236A000180604	5410439108904	60	60	2	17,4	4,0 x 16	Ø5/4	4	150

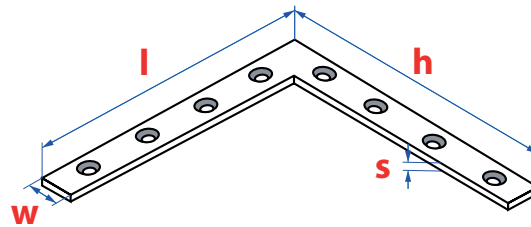



FG0237



Door angle - 90°
Raamhoek - 90°

Equerre pour meubles - 90°
Flachwinkel - 90°



Art. Nr.	EAN Code	w [mm]	l [mm]	s [mm]	h [mm]	Hole pattern Dia. of the hole/nr. of holes		
FG02370010100402	5410439108942	10	40	1,3	40	Ø3/4	20	120
FG02370010100403	5410439108966	10	40	1,3	40	Ø3/4	8	200
FG02370010100502	5410439108980	10	50	1,3	50	Ø3/4	20	90
FG02370010100503	5410439109024	10	50	1,3	50	Ø3/4	8	200
FG02370010100632	5410439109062	10	63	1,3	63	Ø3/4	20	70
FG02370010100633	5410439109079	10	63	1,3	63	Ø3/4	8	150
FG02370010120753	5410439109154	12	75	1,3	75	Ø4/4	8	100
FG02370010151002	5410439109178	15	100	1,5	100	Ø4/5	20	20
FG02370010151003	5410439110853	15	100	1,5	100	Ø4/5	8	40
FG02370010200752	5410439109253	20	75	2	75	Ø4/5	20	20
FG02370010200753	5410439109260	20	75	2	75	Ø4/5	8	40
FG02370010201202	5410439109277	20	120	1,7	120	Ø4/5	20	12
FG02370010201203	5410439110877	20	120	1,7	120	Ø4/5	8	30
FG02370010201502	5410439109284	20	150	2	150	Ø4/5	20	10
FG02370010201503	5410439109291	20	150	2	150	Ø4/5	8	20

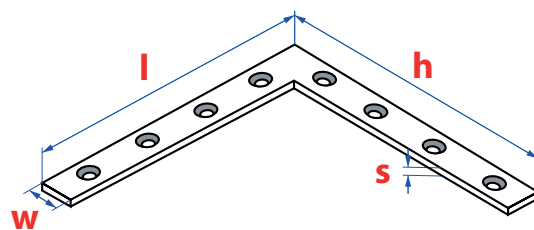

FG0237



Door angle - 90°
Raamhoek - 90°

Equerre pour meubles - 90°
Flachwinkel - 90°

Art. Nr.	EAN Code	w [mm]	l [mm]	s [mm]	h [mm]	Hole pattern Dia. of the hole/nr. of holes	
FG02370010100305	5410439321822	10	30	1,3	30	Ø3/4	100
FG02370010100405	5410439321846	10	40	1,3	40	Ø3/4	100
FG02370010100505	5410439321860	10	50	1,3	50	Ø3/4	100
FG02370010100635	5410439321884	10	63	1,3	63	Ø3/4	100
FG02370010120755	5410439321907	12	75	1,3	75	Ø4/4	100
FG02370010151005	5410439321921	15	100	1,5	100	Ø4/5	50
FG02370010200755	5410439272469	20	75	1,8	75	Ø4/5	100
FG02370010201205	5410439321945	20	120	1,8	120	Ø4/5	50
FG02370010201505	5410439321969	20	150	1,8	150	Ø4/5	50
FG02370010302005	5410439507806	30	200	2,8	200	Ø6,5/6	25
FG02370010302505	5410439507813	30	250	2,8	250	Ø6/6	25

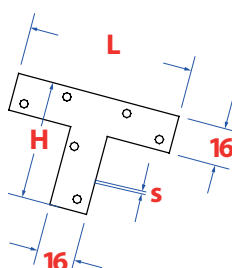

FG0240



T-ridge
T-verbindingssplaat

Equerre modèle T
T-winkel

Art. Nr.	EAN Code	H [mm]	l [mm]	s [mm]	Hole pattern Dia. of the hole/nr. of holes	
FG02400020700505	5410439342742	70	50	2	Ø4/6	100

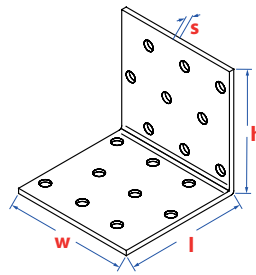

FG0241



DoPn° FG241001A

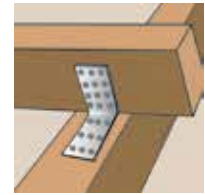

Assembly square multi holes
Versterkingshoek multigaten

Equerre multi-trous
Lochplattenwinkel



Art. Nr.	EAN Code	w [mm]	l [mm]	s [mm]	h [mm]	Hole pattern Dia. of the hole/nr. of holes	
FG02410010400605	5410439360234	40	60	2,5	60	Ø5/6 - Ø5/12	100
FG02410010421255	5410439360999	42	125	2,5	125	4,5/10-6,5/6-10,5/1-10X20/1	50
FG02410010500605	5410439360159	50	60	2,5	60	Ø5/7 - Ø5/15	100
FG02410010600405	5410439322614	60	40	2,5	40	Ø5/5 - Ø5/10	100
FG02410010600605	5410439360258	60	60	2,5	60	Ø5/9 - Ø5/18	100
FG02410010600805	5410439322713	60	80	2,5	80	Ø5/10 - Ø5/10	50
FG02410010601005	5410439322751	60	100	2,5	100	Ø5/13 - Ø5/12	50
FG02410010800605	5410439360173	80	60	2,5	60	Ø5/11 - Ø5/21	50
FG02410010800805	5410439322737	80	80	2,5	80	Ø5/14 - Ø5/14	50
FG02410010801005	5410439360210	80	100	2,5	100	Ø5/17 - Ø5/18	50
FG02410011000605	5410439322690	100	60	2,5	60	Ø5/14 - Ø5/13	50
FG02410011001005	5410439322775	100	100	2,5	100	Ø5/23 - Ø5/45	25

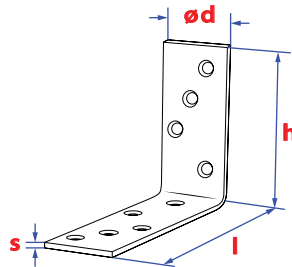

FG0242



Frame connector
Versterkingshoek

Equerre symétrique
Breitwinkel

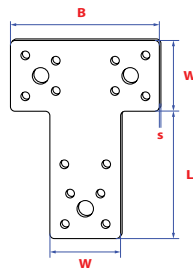

Art. Nr.	EAN Code	d [mm]	l [mm]	s [mm]	h [mm]	Hole pattern Dia. of the hole/nr. of holes	
FG02420010300755	5410439360951	30	100	3	75	Ø5,3/7	20
FG02420010400655	5410439360937	40	65	4	65	Ø4,5/8 - Ø8,1/2	20
FG02420010400855	5410439360975	40	125	4	85	Ø6/9	20

FG0243

T-ridge large
T-verbodingsplaat - Breed

Equerre en T - Large
T-Winkel - breit



Art. Nr.	EAN Code	B [mm]	l [mm]	s [mm]	w [mm]	
FG02430018068385	5410439269124	80	68	2	38	50



Garden fixings

Tuinbevestigingen

Fixations de jardin

Gartenbefestigungen





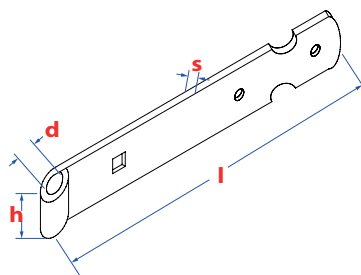

FG0251



Straight hinge
Rechte heng

Penture droite
Ladenband gerade



Art. Nr.	EAN Code	d [mm]	l [mm]	s [mm]	h [mm]	Hole pattern Dia. of the hole/nr. of holes	
FG02510011603005	5410439567961	16	300	5	37,5	Ø8,2/1 - Ø8,8/1	10
FG02510011604005	5410439568005	16	400	5	37,5	Ø8,2/2 - Ø8,8/1	10
FG02510011605005	5410439568142	16	500	5	44,5	Ø8,2/3 - Ø8,8/1	10
FG02510011606005	5410439568166	16	600	5	44,5	Ø8,2/3 - Ø8,8/1	10
FG02510011607005	5410439568180	16	700	5	44,5	Ø8,2/3 - Ø8,8/1	10
FG02510011608005	5410439568203	16	800	5	44,5	Ø8,2/4 - Ø8,8/1	10
FG02510011609005	5410439568227	16	900	5,5	44,5	Ø8,2/5 - Ø8,8/1	10
FG02510011610005	5410439568241	16	1000	5,5	44,5	Ø8,2/5 - Ø8,8/1	10
FG02510011612005	5410439568265	16	1200	5,5	44,5	Ø8,2/5 - Ø8,8/1	10

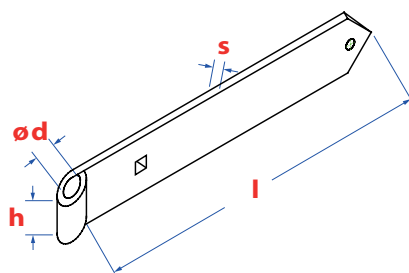

FG0253



Hinge with point
Heng met punt

Penture pointue
Ladenband mit Punkt



Art. Nr.	EAN Code	d [mm]	l [mm]	s [mm]	h [mm]	Hole pattern Dia. of the hole/nr. of holes	
FG02530021606005	5410439392914	16	600	5	45	Ø8,2/3 - Ø8,8/1	10
FG02530021607005	5410439392945	16	700	5	45	Ø8,2/3 - Ø8,8/1	10
FG02530021608005	5410439392952	16	800	5	45	Ø8,2/4 - Ø8,8/1	10
FG02530021610005	5410439392969	16	1000	5,5	45	Ø8,2/5 - Ø8,8/1	10
FG02530021612005	5410439392976	16	1200	5,5	45	Ø8,2/5 - Ø8,8/1	10
FG02530021802005	5410439687379	18	200	4	30	Ø8,5/2	10
FG02530021802505	5410439643603	18	250	4	30	Ø8,5/3	10
FG02530021803005	5410439628310	18	300	4	30	Ø8,5/3	10
FG02530021803505	5410439628273	18	350	4	30	Ø8,5/3	10
FG02530021804005	5410439568029	18	400	4	30	Ø8,5/4	10
FG02530021805005	5410439375672	18	500	4	30	Ø8,5/5	10

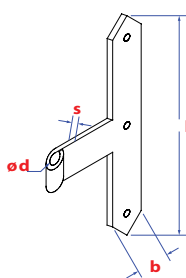

FG0254



Shutter hinge - Type T
Draailuikheng - Type T

Penture équerre - Type T
Winkelband - Typ T



Art. Nr.	EAN Code	d [mm]	l [mm]	b [mm]	s [mm]	Hole pattern Dia. of the hole/nr. of holes	
FG02540021801505	5410439393089	18	150	30	4	Ø8,5/3	10
FG02540021802005	5410439393096	18	200	30	4	Ø8,5/3	10

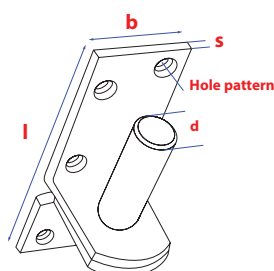

FG0255

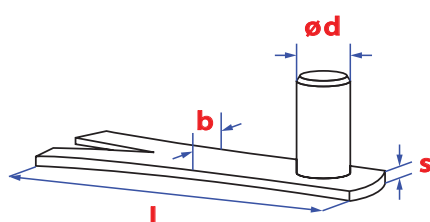

Plate pintle
Plaatduim

Gond sur platine
Haken zum aufschrauben



Art. Nr.	EAN Code	d [mm]	l [mm]	b [mm]	s [mm]	Hole pattern Dia. of the hole/nr. of holes	
FG02550021645385	5410439393119	16	45	40	5	Ø5,7/6	10
FG02550021835305	5410439393133	18	40	33	4	Ø5,5/6	10
FG02550021845385	5410439393126	18	45	40	5	Ø5,5/6	10



FG0256



Pintle for concrete
Betonduim

Gond à bétonner
Haken zum betonieren



Art. Nr.	EAN Code	d [mm]	l [mm]	b [mm]	s [mm]	
FG0256002181055	5410439625111	18	105	30	4	10

FG0257

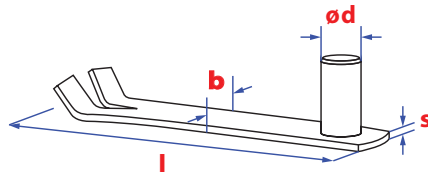

Pintle for bricklaying
Klauwduim voor baksteen

Gond à maçonner
Haken zum einmauern



Art. Nr.	EAN Code	d [mm]	l [mm]	b [mm]	s [mm]	
FG0257001161505	5410439625005	16	150	30	4	10

FG0257

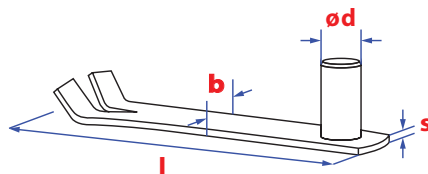

Pintle for bricklaying
Klauwduim voor baksteen

Gond à maçonner
Haken zum einmauern



Art. Nr.	EAN Code	d [mm]	l [mm]	b [mm]	s [mm]	
FG0257002181505	5410439625029	18	150	30	4	10

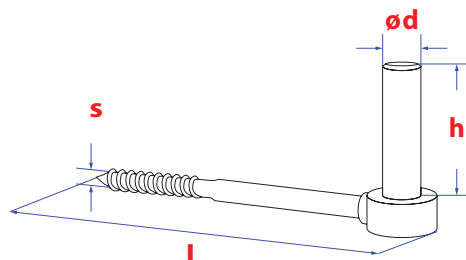

FG0258

Lag screw pintle
Schroefduim

Gond à vis à bois
Haken zum einschrauben



Art. Nr.	EAN Code	d [mm]	l [mm]	s [mm]	h [mm]	
FG0258001161005	5410439569804	16	115	10	55	10

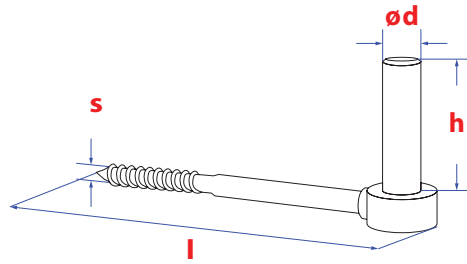

FG0258



Lag screw pintle
Schroefduim

Gond à vis à bois
Haken zum einschrauben



Art. Nr.	EAN Code	d [mm]	l [mm]	s [mm]	h [mm]	
FG0258002181005	5410439687492	18	100	12	35	10

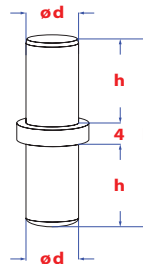

FG0259



Safety pintle
Veiligheidsstift

Axe infrarouge
Sicherungsstift



Art. Nr.	EAN Code	d [mm]	l [mm]	h [mm]	
FG0259002180755	5410439625159	18	75	35	10

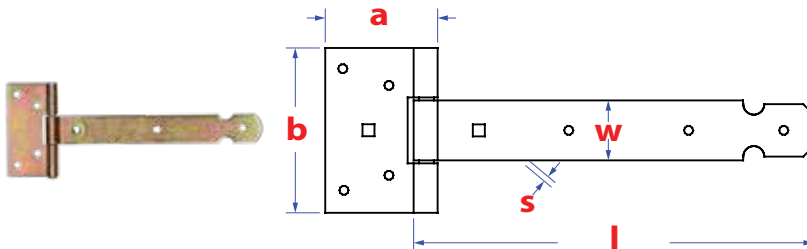

FG0300



Cross hinge - Light version
Kruisheng - Licht type

Penture en croix - Type Légère
Kreuzgehänge - leicht



Art. Nr.	EAN Code	w [mm]	l [mm]	s [mm]	Hole pattern Dia. of the hole/nr. of holes	
FG03000020201005	5410439330749	20	100	2	Ø4,1/6 - Ø5,2/1	6
FG03000020201505	5410439342339	20	150	2	Ø4,1/6 - Ø5,2/1	6
FG03000020352005	5410439342353	35	200	2	Ø5,2/6 - Ø8,8/2	6
FG03000020352505	5410439330763	35	250	2	Ø5,2/6 - Ø8,8/2	6
FG03000020353005	5410439342377	35	300	2	Ø5,2/7 - Ø8,8/2	6
FG03000020355005	5410439510578	35	500	2	Ø5,2/9 - Ø8,8/5	6

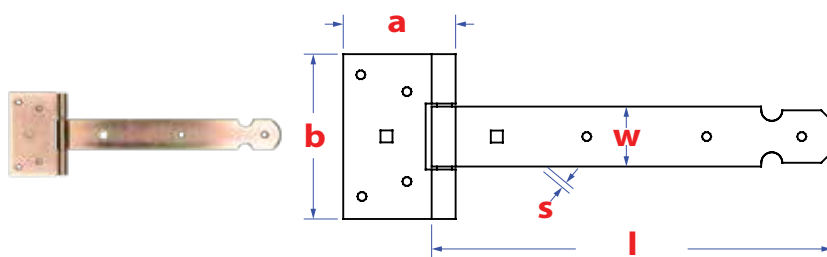

FG0301

LABELED
PER PIECE

Cross hinge - Heavy duty type
Kruisheng - Zwaar type

Penture en croix - Type lourde
Kreuzgehänge - schwer



Art. Nr.	EAN Code	w [mm]	l [mm]	s [mm]	Hole pattern Dia. of the hole/nr. of holes	
FG03010020403005	5410439342391	40	300	4	Ø6,4/2 - Ø5,5/4 - Ø8,4/2	6
FG03010020404005	5410439342414	40	400	4	Ø6,4/2 - Ø5,5/4 - Ø8,4/2	6
FG03010020405005	5410439342438	40	500	4	Ø6,4/3 - Ø5,5/4 - Ø8,4/2	6
FG03010020406005	5410439330817	40	600	4	Ø6,4/3 - Ø5,5/4 - Ø8,4/3	10

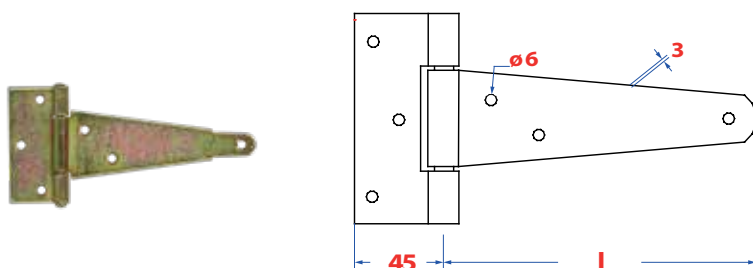

FG0302

LABELED
PER PIECE

T-Hinge
T-Heng

Penture anglaise
T-Gehänge



Art. Nr.	EAN Code	l [mm]	
FG03020020755	5410439625227	75	12
FG03020021005	5410439393171	100	12
FG03020021255	5410439625272	125	12
FG03020021505	5410439625296	150	12
FG03020021755	5410439393188	175	6
FG03020022005	5410439625319	200	6
FG03020022505	5410439625333	250	6
FG03020023005	5410439393195	300	6

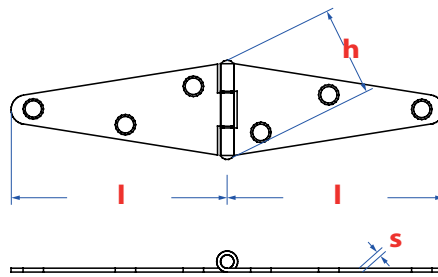

FG0303

LABELED
PER PIECE

Straight strap hinge - Light version
Staartheng - Licht type

Penture anglaise double - Type légère
Scharnier - leicht



Art. Nr.	EAN Code	l [mm]	h [mm]	s [mm]	
FG03030010755	5410439568302	75	27	1,5	10
FG03030011005	5410439568326	100	30	1,75	10
FG03030011255	5410439568340	125	34	2	10
FG03030011505	5410439568364	150	38	2	10
FG03030012005	5410439568388	200	44	2	10
FG03030012505	5410439568401	250	50	2	10

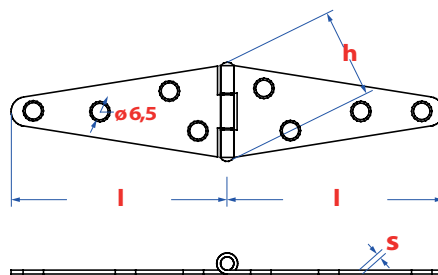

FG0304

LABELED
PER PIECE

Double tailhinge - Heavy version
Dubbele staartscharnier - Zwaar type

Penture double - Type forte
Doppelten Kistenband - schwer



Art. Nr.	EAN Code	l [mm]	h [mm]	s [mm]	
FG03040022005	5410439331968	200	50	2,5	12
FG03040022505	5410439395663	250	50	2,5	12
FG03040023005	5410439395670	300	50	2,5	12

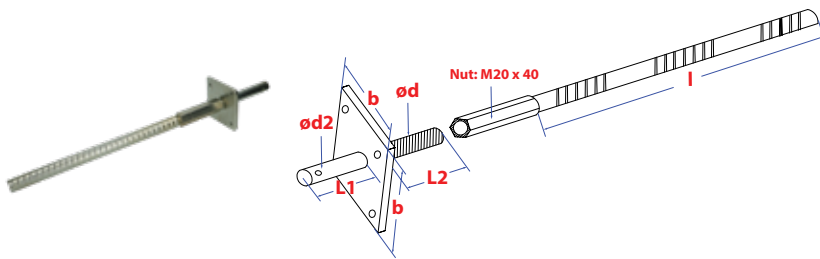

FG0307



Adjustable anchor
Verstelbaar instortanker m. pin

Ancrage réglable
Stützenfuss verstellbar mit Stange



Art. Nr.	EAN Code	d [mm]	l [mm]	b [mm]	d2 [mm]	L1 [mm]	L2 [mm]	
FG03070011101105	5410439034968	24	340	110	24	150	60	10

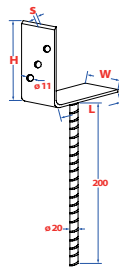

FG0310

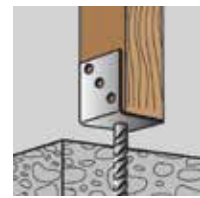

Column shoe with rebar - Type L
Balkenvoet met betonijzer - Type L

Pied de poteau avec fer de béton - Type L
Pfostenträger mit Riffeldolle - Typ L



Art. Nr.	EAN Code	w [mm]	l [mm]	s [mm]	h [mm]	Hole pattern Dia. of the hole/nr. of holes	
FG03100100600915	5410439343756	60	80	4	100	Ø11/3	10

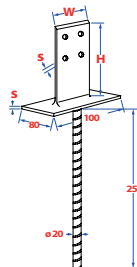

FG0311



Column shoe with rebar - Type T
Balkenvoet met betonijzer - Type T

Pied de poteau avec fer de béton - Type T
Pfostenträger mit Riffeldolle - Typ T



Art. Nr.	EAN Code	w [mm]	h [mm]	s [mm]	Hole pattern Dia. of the hole/nr. of holes	
FG03110100701105	5410439343848	70	110	8	Ø10/4	10

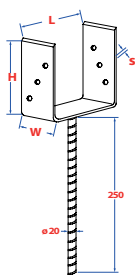

FG0312

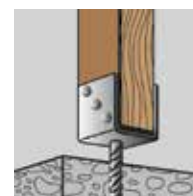

Column shoe with rebar - Type U
Balkenvoet met betonijzer - Type U

Pied de poteau avec fer de béton - Type U
Pfosträger mit Riffeldolle - Typ U



Art. Nr.	EAN Code	w [mm]	l [mm]	s [mm]	h [mm]	Hole pattern Dia. of the hole/nr. of holes	
FG03120100600715	5410439343770	60	71	4	100	Ø11/6	10
FG03120100600815	5410439343794	60	81	4	100	Ø11/6	10
FG03120100600915	5410439343817	60	91	4	100	Ø11/6	10

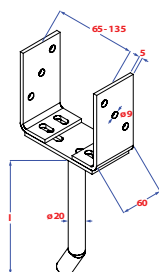

FG0313



Pergola support with rebar
Pergolasteun met betonijzer

Support de pergola avec fer pour béton
Pergola-Unterstützung mit Dolle

Art. Nr.	EAN Code	d [mm]	l [mm]	Hole pattern Dia. of the hole/nr. of holes	
FG03130100651355	5410439272971	65	190	Ø9/6	1

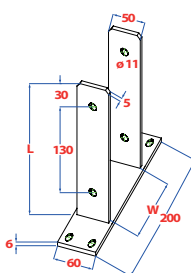

FG0316



DoPn° FG316001

Column shoe with anchoring pl. - Type U
Balkenvoet met bevestigingspl. - Type U

Pied de poteau avec patte de fixation - Type U
Pfosträger zum aufdübeln - Typ U



Art. Nr.	EAN Code	w [mm]	l [mm]	Hole pattern Dia. of the hole/nr. of holes	
FG03160100712005	5410439343909	71	200	Ø11/8	10
FG03160100812005	5410439343923	81	200	Ø11/8	10
FG03160100912005	5410439343947	91	200	Ø11/8	10

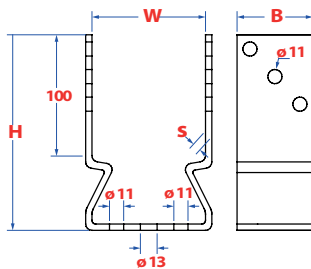

FG0317

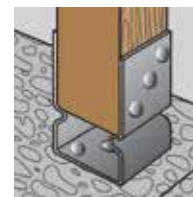

Column shoe - Type U
Balkenvoet met opschroefb. steun - Type U

Support de poutre - Type U
Pfostenträger U mit Balkenauflege



Art. Nr.	EAN Code	w [mm]	H [mm]	b [mm]	s [mm]	Hole pattern Dia. of the hole/nr. of holes	
FG03170100711505	5410439361552	71	150	60	5	$\phi 11/8 - \phi 13/1$	1
FG03170100911505	5410439361569	91	150	60	5	$\phi 11/8 - \phi 13/1$	1

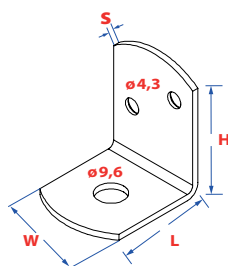

FG0319



Fence holder - Type L
Vlecht schermsteun - Type L

Support panneau tresse - Type L
Flechtzaunbeschlag - Typ L



Art. Nr.	EAN Code	d [mm]	l [mm]	s [mm]	h [mm]	w [mm]	Hole pattern Dia. of the hole/nr. of holes	
FG0319A000305	5410439007405	30	35	2	40	30	2/4,3 - 1/9,6	25

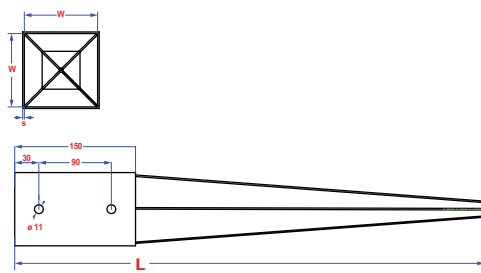

FG0320

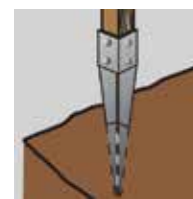

Pointed pole anchor
Paalhouder met punt

Pied de poteau de jardin pointu
Pfostenträger Rakete



Art. Nr.	EAN Code	w [mm]	l [mm]	s [mm]	Hole pattern Dia. of the hole/nr. of holes	
FG03200100717505	5410439343961	71	750	2	$\phi 11/4$	1
FG03200100917505	5410439386425	91	750	2	$\phi 11/4$	1
FG03200100919005	5410439343978	91	900	2	$\phi 11/4$	1

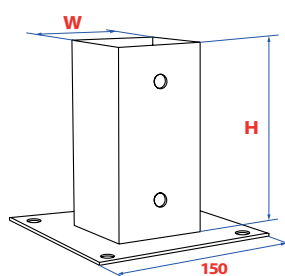

FG0321

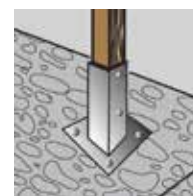

Post holder with anchor plate
Paalhouder op plaat

Pied de poteau avec patte d'ancrage
Pfostenträger mit Grundplatte



Art. Nr.	EAN Code	w [mm]	H [mm]	s [mm]	Hole pattern Dia. of the hole/nr. of holes	
FG03210100711505	5410439343985	71	150	2	Ø10,5/12	1
FG03210100911505	5410439343992	91	150	2	Ø10,5/12	1
FG03210101211505	5410439027274	121	150	2	-	1

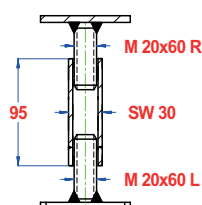
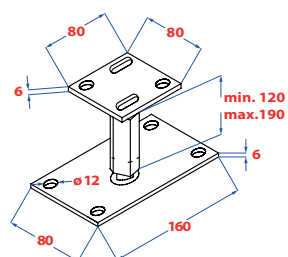

FG0322



DoPh[®] FG322001

Hight adjustable post holder - Type P
Paalhouder verstelbare hoogte - Type P

Pied de poteau ajustable en hauteur - Type P
Pfostenträger Höhenverstellung - Typ P



Art. Nr.	EAN Code	d [mm]	l [mm]	Hole pattern Dia. of the hole/nr. of holes	
FG0322002801605	5410439339698	80	160	Ø13/6 - Ø23X13/2	10

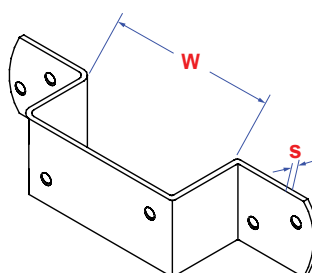

FG0324



Fence holder combi
Vlechtschermsteun combi

Support panneau tresse combi
Flechtzaunbeschlag combi



Art. Nr.	EAN Code	w [mm]	s [mm]	Hole pattern Dia. of the hole/nr. of holes	
FG03240020700705	5410439568722	70	2	Ø5/2	100
FG03240020900905	5410439568739	90	2	Ø5/2	100

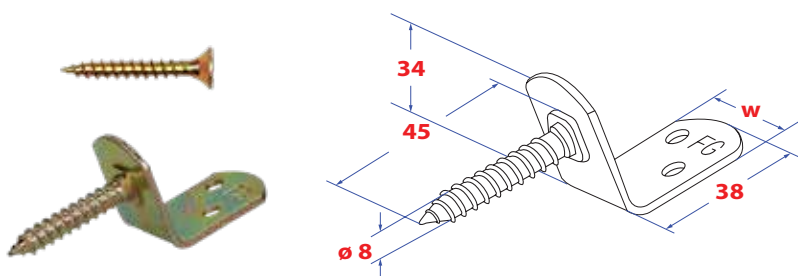



FG0325



Fence holder Type L with screws
Vlechtschermsteun Type L met schroeven

Support panneau tresse Type L avec vis
Flechtzaunbeschlag Typ L mit Schrauben



Art. Nr.	EAN Code	w [mm]	s [mm]	Screw size	Hole pattern Dia. of the hole/nr. of holes		
FG0325002SET5	5410439344104	30	2	4,0 x 25	Ø5/2	1	50

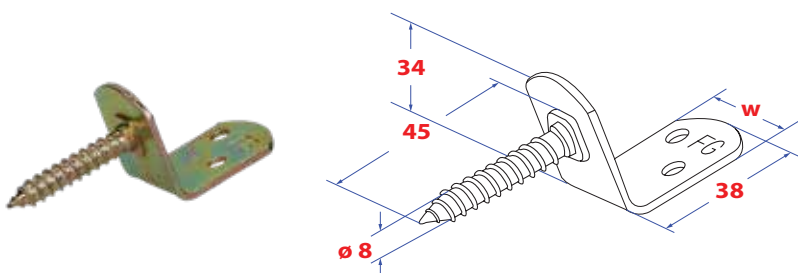

FG0325



Fence holder Type L
Vlechtschermsteun Type L

Support panneau tresse Type L
Flechtzaunbeschlag Typ L



Art. Nr.	EAN Code	w [mm]	s [mm]	Hole pattern Dia. of the hole/nr. of holes	
FG03250020305	5410439344098	30	2	Ø5/2	100

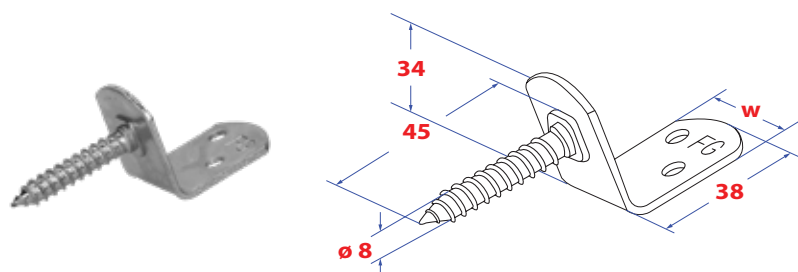

FG0325



Fence holder Type L
Vlechtschermsteun Type L

Support panneau tresse Type L
Flechtzaunbeschlag Typ L



Art. Nr.	EAN Code	w [mm]	s [mm]	Hole pattern Dia. of the hole/nr. of holes	
FG03250100305	5410439344081	30	2	Ø5/2	100

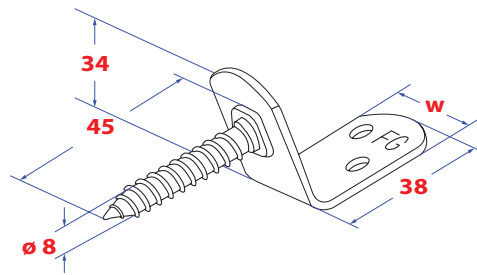

FG0325



Fence holder Type L with screws
Vlechtschermsteun Type L met schroeven

Support panneau tresse Type L avec vis
Flechtzaunbeschlag Typ L mit Schrauben



Art. Nr.	EAN Code	w [mm]	s [mm]	Screw size		
FG0325A00SET5	5410439632324	30	2	4,0 x 25	1	50

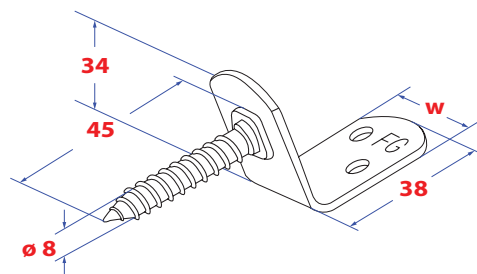

FG0325



Fence holder Type L
Vlechtschermsteun Type L

Support panneau tresse Type L
Flechtzaunbeschlag Typ L



Art. Nr.	EAN Code	w [mm]	s [mm]	
FG0325A000305	5410439344067	30	2	100

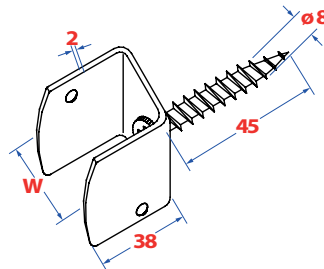

FG0326



Fence holder Type U
Vlechtschermsteun Type U

Support panneau tresse Type U
Flechtzaunbeschlag Typ U



Art. Nr.	EAN Code	w [mm]	
FG0326002385	5410439344128	38	50
FG0326002485	5410439344142	48	1

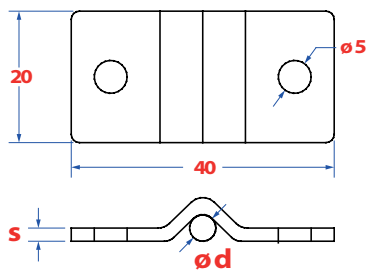

FG0327

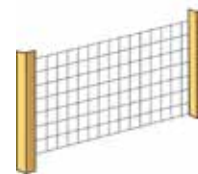

Bracket for panel fencing
Draadpaneelklem

Fixation treillis
Befestigungsschele

Art. Nr.	EAN Code	d [mm]	s [mm]	Hole pattern Dia. of the hole/nr. of holes	
FG0327001045	5410439388412	4	2	Ø5/2	100
FG0327001065	5410439393478	6	2	Ø5/2	100

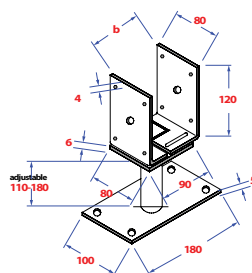

FG0328



DoPh® FG328001

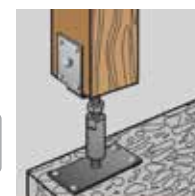

Column shoe adj. in height and width
Verstelbare voet in hoogte en breedte

Pied de poteau réglable en hauteur et largeur
Pfostenr. höhen- und seitenverstellb.



Art. Nr.	EAN Code	b min [mm]	b max [mm]	Hole pattern Dia. of the hole/nr. of holes	
FG032801080160A5	5410439343381	80	160	Ø5/2	10

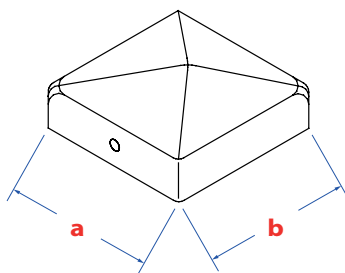

FG0329



Pole cover - Pyramid type
Paalkap - piramidevormig

Ornement de poteau - Forme pyramide
Pfostenkappe - Pyramideförmig



Art. Nr.	EAN Code	a [mm]	b [mm]	Hole pattern Dia. of the hole/nr. of holes	
FG03290100710715	5410439624473	71	71	Ø5/2	1
FG03290100910915	5410439624497	91	91	Ø5/2	1

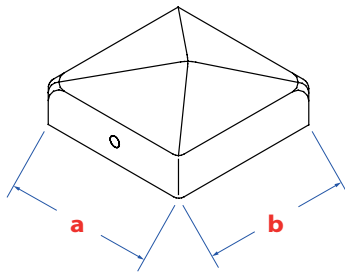

FG0329

Pole cover - Pyramid type
Paalkap - piramidevormig

Ornement de poteau - Forme pyramide
Pfostenkappe - Pyramideförmig



Art. Nr.	EAN Code	a [mm]	b [mm]	Hole pattern Dia. of the hole/nr. of holes	
FG0329A000710715	5410439646758	71	71	Ø5/2	1
FG0329A000910915	5410439646772	91	91	Ø5/2	1

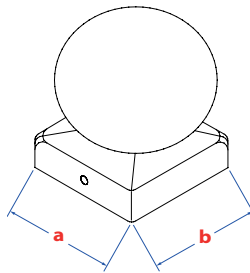

FG0330

Pole cover - Ball type
Paalkap - bolvormig

Ornement de poteau - Forme boule
Pfostenkappe - Kugelförmig



Art. Nr.	EAN Code	a [mm]	b [mm]	Hole pattern Dia. of the hole/nr. of holes	
FG03300100710715	5410439568845	71	71	Ø2,5/2	1
FG03300100910915	5410439568869	91	91	Ø3/2	1

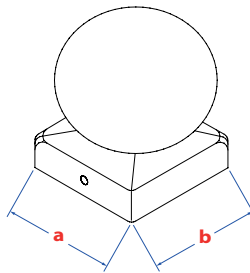

FG0330

Pole cover - Ball type
Paalkap - bolvormig

Ornement de poteau - Forme boule
Pfostenkappe - Kugelförmig



Art. Nr.	EAN Code	a [mm]	b [mm]	Hole pattern Dia. of the hole/nr. of holes	
FG0330A000710715	5410439646796	71	71	Ø2,5/2	1
FG0330A000910915	5410439646819	91	91	Ø2,5/2	1

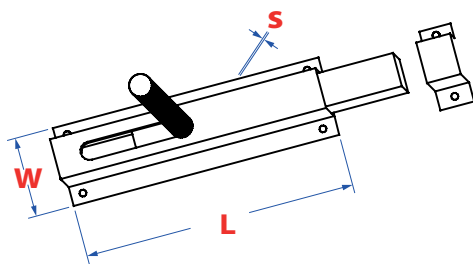

FG0331

LABELED
PER PIECE

Plane sliding latch - Light version
Vlakke schuif - Licht type

Verrou de fenetre plat - Type légère
Fensterriegel gerade



Art. Nr.	EAN Code	w [mm]	l [mm]	s [mm]	
FG0331001350605	5410439337618	35	60	1	12
FG0331001350805	5410439337632	35	80	1	12
FG0331001351005	5410439337656	35	100	1	12
FG0331001351205	5410439337670	35	120	1	12

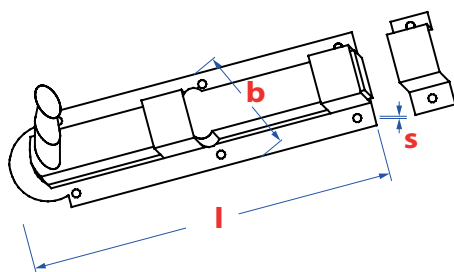

FG0332

LABELED
PER PIECE

Plane window sliding latch
Vlakke raamschuif

Verrou pêne plat bouton
Schlossriegel gerade



Art. Nr.	EAN Code	b [mm]	l [mm]	s [mm]	
FG0332001200405	5410439568661	20	40	1	10
FG0332001250605	5410439568623	25	60	1	10
FG0332001250805	5410439568685	25	80	1	10
FG0332001301005	5410439568708	30	100	1	10
FG0332001301205	5410439482561	30	120	1	10

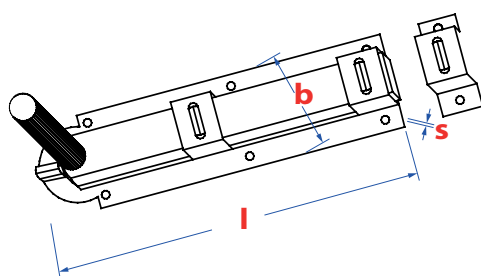

FG0333



Plane roll latch
Vlakke deurrolschuif

Verrou à coulisse
Rollen-Schlossriegel gerade



Art. Nr.	EAN Code	b [mm]	l [mm]	s [mm]	Hole pattern Dia. of the hole/nr. of holes	
FG0333002451005	5410439568500	45	100	2	Ø4,6/8	10
FG0333002551205	5410439568524	55	120	2	Ø4,6/8	10
FG0333002551405	5410439568548	55	140	2	Ø4,6/8	10
FG0333002651605	5410439568555	65	160	2	Ø4,6/8	10
FG0333002751805	5410439568586	75	180	2	Ø4,6/8	5
FG0333002752005	5410439568593	75	200	2	Ø4,6/8	5

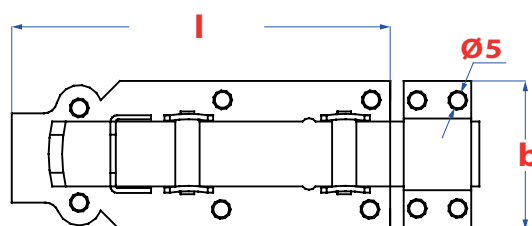

FG0334



Flat padlock sliding bolt
Vlakke hangslotrolschuif

Verrou pour cadenas à rouleau plat
Rollenschlossriegel flach



Art. Nr.	EAN Code	l [mm]	b [mm]	Hole pattern Dia. of the hole/nr. of holes	
FG03340021605	5410439363167	160	70	Ø5/10	1

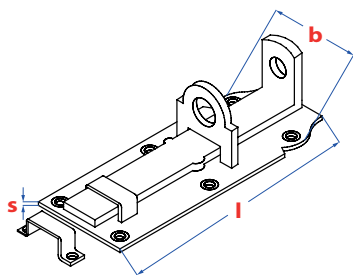

FG0336

LABELED
PER PIECEPlane latch for padlock
Vlakke hangslotschuifVerrou à porte-cadenas plat
Schlossriegel gerade

Art. Nr.	EAN Code	b [mm]	l [mm]	s [mm]	Hole pattern Dia. of the hole/nr. of holes	
FG03360021005	5410439589086	45	100	2	Ø4,6/8	10
FG03360021205	5410439589093	55	120	2	Ø4,5/8	10
FG03360021405	5410439589109	55	140	2	Ø4,5/8	10
FG03360021605	5410439589116	65	160	2	Ø4,5/8	10

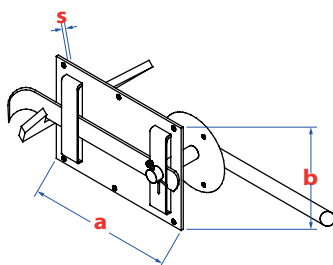

FG0341

LABELED
PER PIECEFarmer gate latch
Boerenklinkstel met inslagneusFermeture à l'ancienne
Gartentorfall mit Einschlagnase

Art. Nr.	EAN Code	a [mm]	b [mm]	s [mm]	Hole pattern Dia. of the hole/nr. of holes	
FG03410011200855	5410439631693	120	85	2	Ø3/4 - Ø3,6/6	10

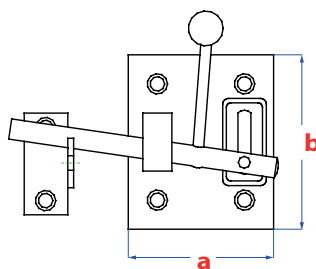
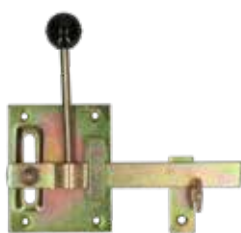

FG0343

LABELED
PER PIECEGarden gate latch
TuinhekssluitingFermeture porte de jardin
Gartentorfall

Art. Nr.	EAN Code	a [mm]	b [mm]	Hole pattern Dia. of the hole/nr. of holes	
FG03430021001805	5410439425001	100	180	Ø4,8/4 - Ø5,8/2	10

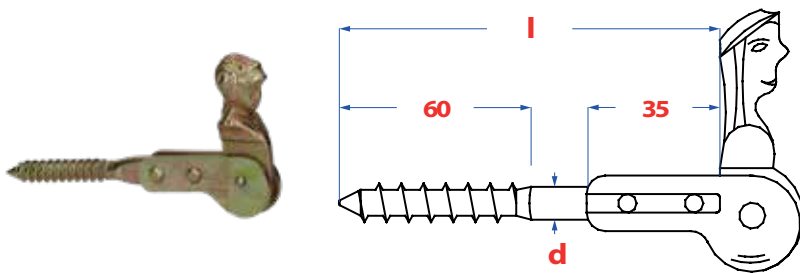

FG0349



Shutter catch "shepherdress" wood thread
Herderinnekopje met houtdraad

Arrêt tête bergère à vis à bois
Fensterlade-Feststeller mit Holzgewinde



Art. Nr.	EAN Code	d [mm]	l [mm]	
FG0349002101155	5410439393157	10	115	10

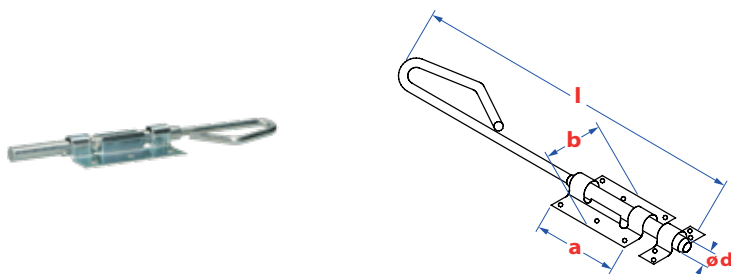

FG0351



Barrel bolt
Bajonetrendel

Verrou à baionette
Bolzenstangenriegel



Art. Nr.	EAN Code	d [mm]	l [mm]	b [mm]	a [mm]	
FG03510010002005	5410439441797	10	200	60	80	6
FG03510010002505	5410439441803	10	250	60	80	6
FG03510010003005	5410439441810	10	300	60	80	6
FG03510010003205	5410439323895	15	320	70	100	5
FG03510010004005	5410439323918	15	400	70	100	5
FG03510010005005	5410439323932	15	500	70	100	5
FG03510010006005	5410439323956	15	600	70	100	5
FG03510010008005	5410439605328	15	800	70	100	5
FG03510010010005	5410439323963	15	1000	70	100	5

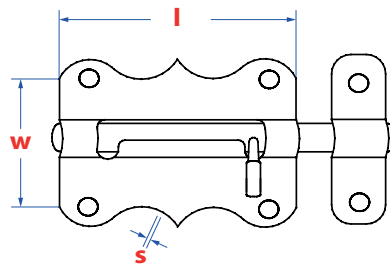

FG0352

LABELED
PER PIECE

Slide bolt - American type
Amerikaanse grendel

Verrou à glissiere - Type Américaine
Grendelriegel - Amerikanische typ



Art. Nr.	EAN Code	w [mm]	l [mm]	s [mm]	Hole pattern Dia. of the hole/nr. of holes	
FG03520010000355	5410439323987	35	38	1	Ø4/6	12
FG03520010000405	5410439324007	40	43	1	Ø4/6	12
FG03520010000505	5410439337564	50	50	1	Ø4/6	12
FG03520010000705	5410439324021	70	60	1	Ø4/6	12

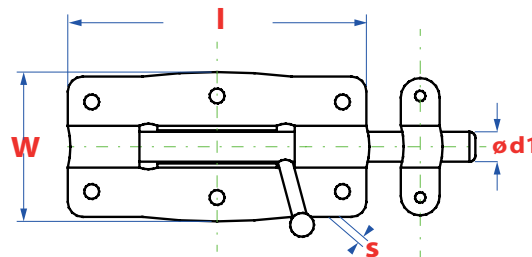

FG0353

LABELED
PER PIECE

Slide bolt
Plaatgrendel

Verrou à glissiere
Grendelriegel



Art. Nr.	EAN Code	w [mm]	l [mm]	s [mm]	d1 [mm]	Hole pattern Dia. of the hole/nr. of holes	
FG03530010000805	5410439324045	80	50	1,5	10	Ø4,5/6	12
FG03530010001005	5410439324069	100	50	1,5	-	Ø4,5/8	12
FG03530010001205	5410439324083	120	81	1,5	13	Ø5,3/10	12

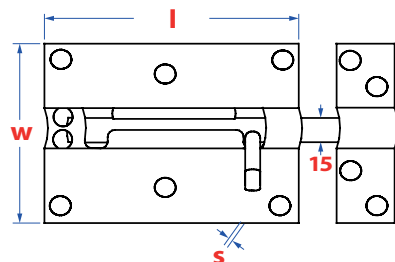

FG0354

LABELED
PER PIECE

Slide bolt for padlock
Hangslotgrendel met oogslot achteraan

Verrou à porte-cadenas
Grendelriegel - abschliessbar

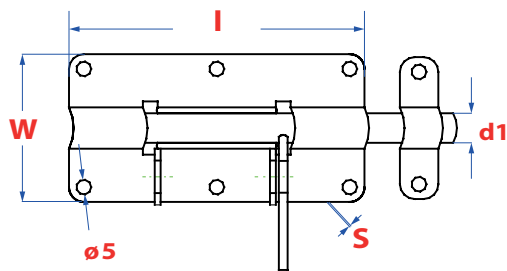

Art. Nr.	EAN Code	w [mm]	l [mm]	s [mm]	
FG03540011000755	5410439324106	100	75	1,5	12

**FG0355**LABELED
PER PIECE

Slide bolt for padlock
Hangslotgrendel

Verrou à porte-cadenas
Grendelriegel - abschliessbar

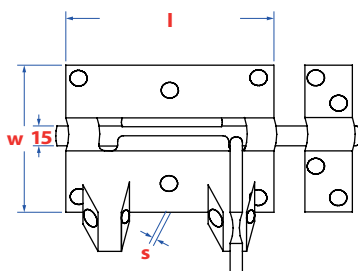

Art. Nr.	EAN Code	w [mm]	l [mm]	s [mm]	d1 [mm]	Hole pattern Dia. of the hole/nr. of holes	
FG03550010501005	5410439324137	50	100	1,5	Ø10	Ø4,2/6	12

**FG0356**LABELED
PER PIECE

Slide bolt for padlock
Hangslotgrendel

Verrou à porte-cadenas
Grendelriegel - abschliessbar

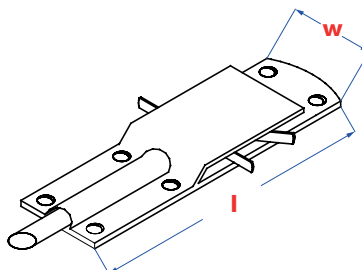

Art. Nr.	EAN Code	w [mm]	l [mm]	s [mm]	
FG03560010701005	5410439269674	70	100	1,5	12

**FG0357**LABELED
PER PIECE

Security bolt for pig stable
Varkenshok veiligheidsrendel

Verrou d'étable de sécurité
Sicherheitsstallriegel



Art. Nr.	EAN Code	w [mm]	l [mm]	Hole pattern Dia. of the hole/nr. of holes	
FG03570010652005	5410439442619	65	200	Ø5,1/6 - Ø3,5/1	5

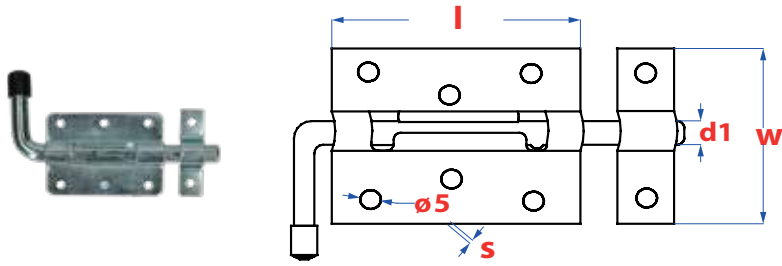

FG0358

Labeled
per piece

Pistol latch
Pistoolgrendel

Verrou pistolet
Pistolriegel



Art. Nr.	EAN Code	w [mm]	l [mm]	s [mm]	d1 [mm]	Hole pattern Dia. of the hole/nr. of holes	
FG03580020600805	5410439389457	60	80	1,5	Ø12	Ø5/8	10



Miscellaneous

Diversen

Divers

Sonstiges





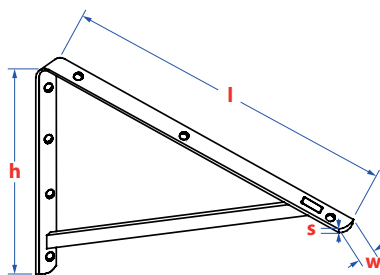

FG0380



Shelf bracket - Heavy type
Plankendrager met steun - Zwaar type

Support de table - Lourd
Konsolenstutze - schwer



Art. Nr.	EAN Code	w [mm]	l [mm]	s [mm]	h [mm]	
FG03800012003005	5410439324144	30	300	4	200	10
FG03800012504005	5410439337427	30	400	4	250	10
FG03800013305005	5410439337441	30	500	4	330	10

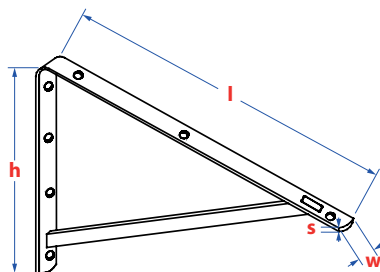

FG0380



Shelf bracket - Heavy type
Plankendrager met steun - Zwaar type

Support de table - Lourd
Konsolenstutze - schwer



Art. Nr.	EAN Code	w [mm]	l [mm]	s [mm]	h [mm]	
FG03800742003005	5410439324168	30	300	4	200	10
FG03800742504005	5410439324182	30	400	4	250	10
FG03800743305005	5410439324205	30	500	4	330	10

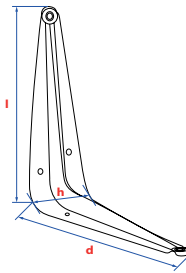

FG0382



Pressed shelf bracket - Type 1
Geperste plankendrager - Type 1

Console emboutie - Type 1
Blechkonsole - Typ 1



Art. Nr.	EAN Code	d [mm]	l [mm]	h [mm]	
FG03820711001255	5410439273268	100	125	34	20
FG03820711251505	5410439273251	125	150	35	20
FG03820711502005	5410439273244	150	200	41	20
FG03820712002505	5410439273237	200	250	42	20
FG03820712503005	5410439273220	250	300	45	20
FG03820713003505	5410439273213	300	350	48	20

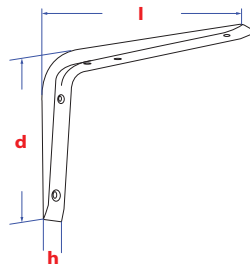

FG0383



Pressed shelf bracket - Type 2
Geperste plankendrager - Type 2

Console emboutie - Type 2
Blechkonsole - Typ 2



Art. Nr.	EAN Code	d [mm]	l [mm]	h [mm]	
FG03830711251505	5410439055833	125	150	24	10
FG03830711502005	5410439273282	150	200	26	12
FG03830712002505	5410439273299	200	250	30	12
FG03830712503005	5410439273275	250	300	34	12

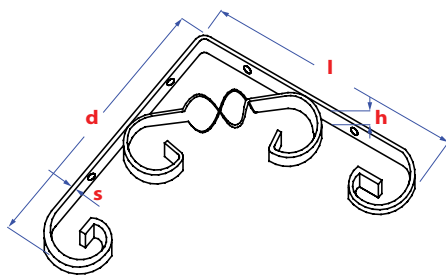

FG0384



Ornamental shelf bracket
Ornamentale plankendrager

Console ornamental
Konsole ornamental



Art. Nr.	EAN Code	d [mm]	l [mm]	s [mm]	h [mm]	Hole pattern Dia. of the hole/nr. of holes	
FG03840711001005	5410439273336	100	100	3	16	Ø5/5	10
FG03840711501505	5410439273329	150	150	3	13	Ø5/5	10
FG03840712002005	5410439273312	200	200	3	13	Ø5/5	10
FG03840712502505	5410439273305	250	250	3	13	Ø5/5	10

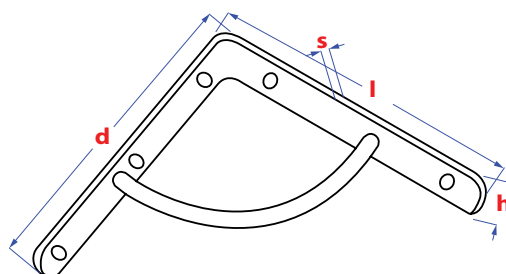

FG0385



Shelf bracket
Plankendrager

Console
Konsole



Art. Nr.	EAN Code	d [mm]	l [mm]	s [mm]	h [mm]	
FG03850711401405	5410439273404	140	140	3	20	10
FG03850711901905	5410439273398	190	190	5	20	10
FG03850712402405	5410439273381	240	240	5	20	10

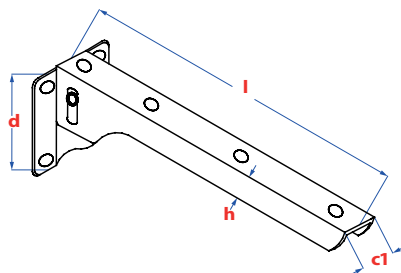

FG0388



Foldable shelf bracket
Inklapbare plankendrager

Console pliable
Konsole klappbar



Art. Nr.	EAN Code	d [mm]	l [mm]	c [mm]	h [mm]	
FG03880010602005	5410439273190	60	180	20	15	2
FG03880010603005	5410439273206	60	300	20	15	2

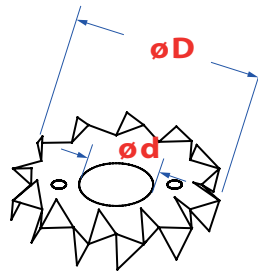

FG0413



DoPn° FG413001



Timber connector double sided
Kramplaat dubbelzijdig getand

Crampon double denture
Holzverbinder dorne zweiseitig



Art. Nr.	EAN Code	d [mm]	l [mm]	Hole pattern Dia. of the hole/nr. of holes	
FG04130010480175	5410439646949	48	17	Ø3,5/2 - Ø17/1	200
FG04130010750265	5410439646963	75	26	Ø5/2 - Ø26/1	100

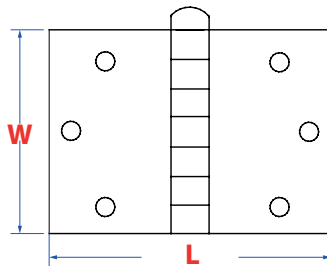

FG0421



Rolled knuckle hinge straight corners
Gerolde knopscharnier rechte hoeken

Charniere à noeud angle droite 90°
Stangenscharnier gerollt Winkel 90°



Art. Nr.	EAN Code	w [mm]	l [mm]	
FG04210010760765	5410439340250	76,2	76	24

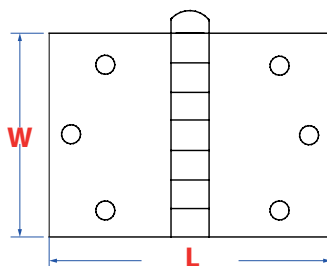

FG0421



Rolled knuckle hinge straight corners
Gerolde knopscharnier rechte hoeken

Charniere à noeud angle droite 90°
Stangenscharnier gerollt Winkel 90°



Art. Nr.	EAN Code	w [mm]	l [mm]	
FG04210020760765	5410439340274	76,2	76	24

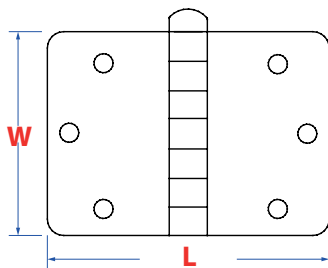

FG0422



Rolled hinge round corners and head
Gerolde scharnier ronde hoeken en balkop

Charniere roulee angle arondi et tête ronde
Geroldes scharn. Hecke abger. und Rund-
kopt



Art. Nr.	EAN Code	w [mm]	l [mm]	
FG04220020760765	5410439340298	76,2	76	24

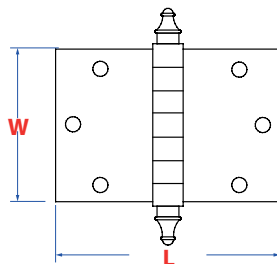

FG0423



Rolled knuckle hinge straight corners-plug
Gerolde knopsch. rechte hoeken en vaaskop

Charn. à noeuds roulee angle 90°-vase
Stangenscharnier gerollt Winkel 90° stopfen



Art. Nr.	EAN Code	w [mm]	l [mm]	
FG04230010760765	5410439340335	76,2	76	24

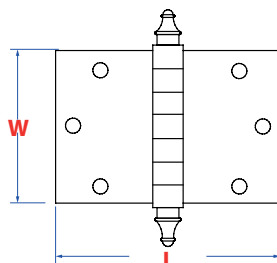

FG0423



Rolled knuckle hinge straight corners-plug
Gerolde knopsch. rechte hoeken en vaaskop

Charn. à noeuds roulee angle 90°-vase
Stangenscharnier gerollt Winkel 90° stopfen



Art. Nr.	EAN Code	w [mm]	l [mm]	
FG04230020760765	5410439340359	76,2	76	24

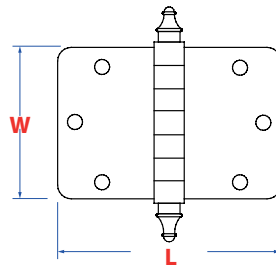

FG0424



Rolled knuckle hinge rounded corners-plug
Gerolde knopsch. ronde hoeken en vaaskop

Charn. à noeuds roulee angl. arondis-vase
Stangenscharn. gerollt Winkel abger.-stop-
fen



Art. Nr.	EAN Code	w [mm]	l [mm]	
FG04240020760765	5410439324229	76,2	76	24



Construction & Wall ties

Constructie & Muurbevestigingen

Construction & Fixations pour mur

Konstruktion & Mauerverbindungen



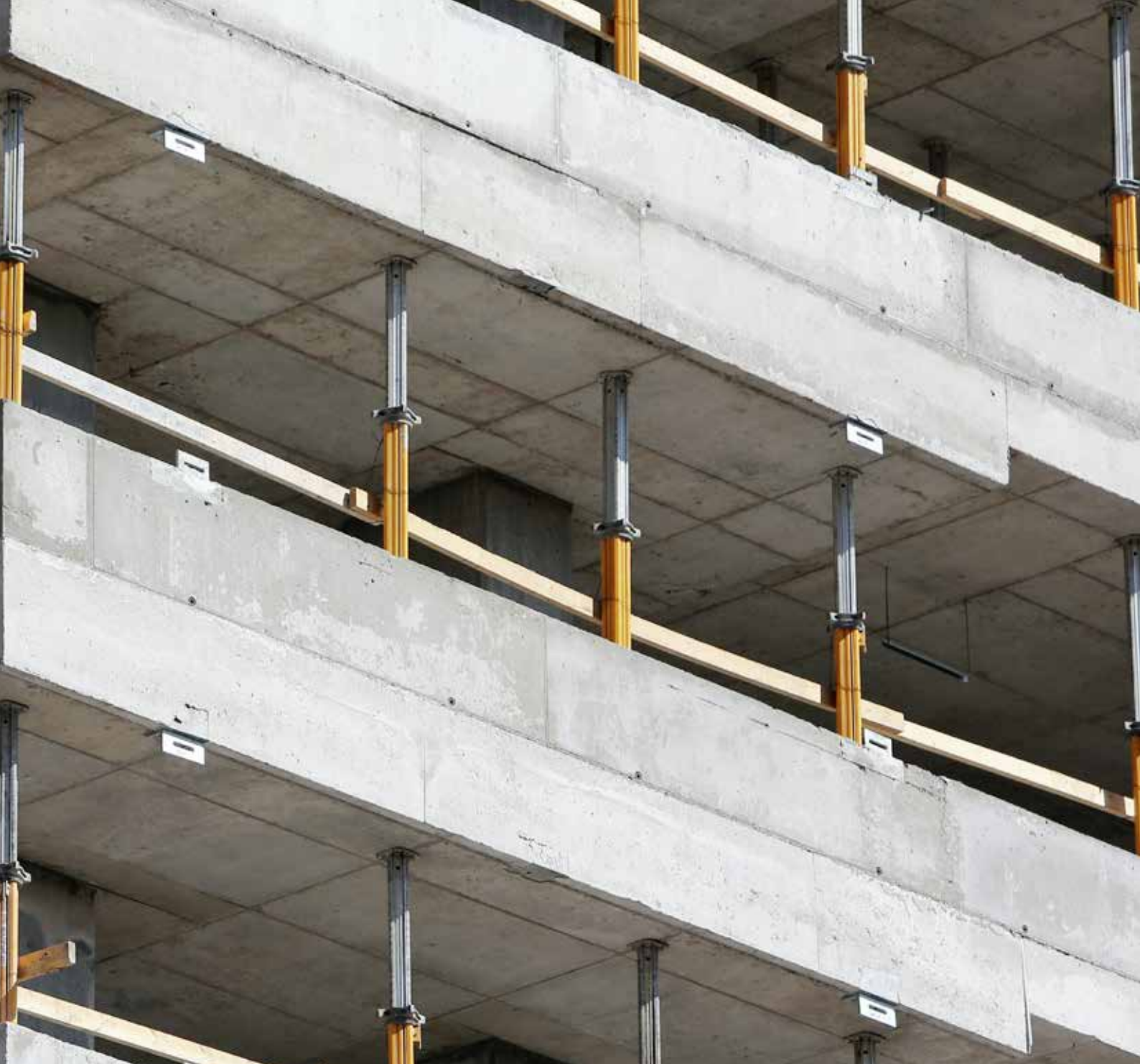

FG0517

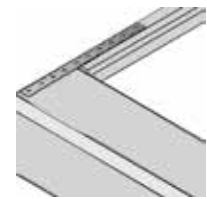
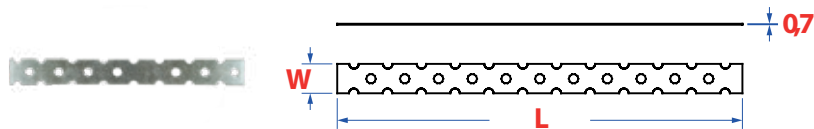

Wall junction strip
Lijmkoppelstrip

Raccord à coller
Mauerverbinder



Art. Nr.	EAN Code	w [mm]	l [mm]	s [mm]	Hole pattern Dia. of the hole/nr. of holes	
FG05170010222005	5410439567695	22	200	0,7	Ø7/7	250
FG05170010223005	5410439567718	22	300	0,7	Ø7/11	250
FG05170010224005	5410439567732	22	400	0,7	Ø7/14	250

FG0517

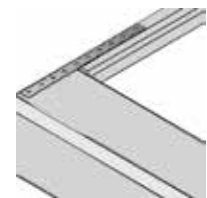
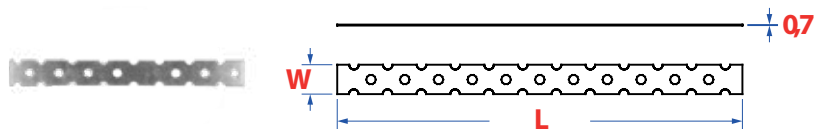

Wall junction strip
Lijmkoppelstrip

Raccord à coller
Mauerverbinder



Art. Nr.	EAN Code	w [mm]	l [mm]	s [mm]	Hole pattern Dia. of the hole/nr. of holes	
FG0517B000223005	5410439646734	22	300	0,7	Ø7/11	250

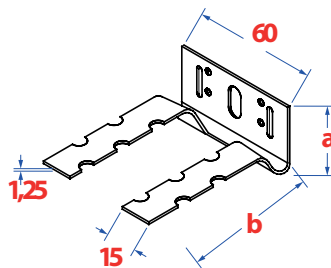

FG0521

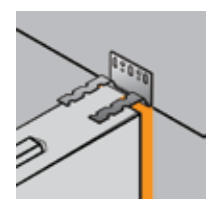

Flexible wall clamp
Uizetbaar wandanker

Ancrage mur dilatant
Wandanker beweglich



Art. Nr.	EAN Code	a [mm]	b [mm]	Hole pattern Dia. of the hole/nr. of holes	
FG052100140885	5410439567756	40	88	Ø4/2 - Ø5/2	100

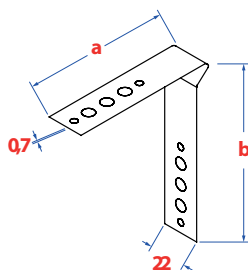

FG0523

Spring anchor
VeerankerAncrage dilatant
Federanker

Art. Nr.	EAN Code	a [mm]	b [mm]	Hole pattern Dia. of the hole/nr. of holes	
FG0523001901035	5410439567770	90	103	Ø4/4 - Ø7/6	100

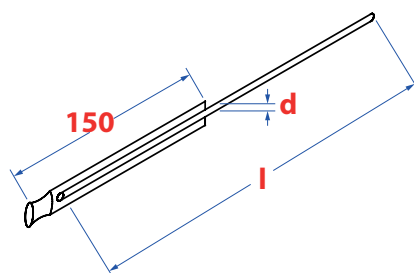

FG0526

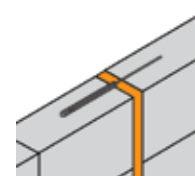
Slip tie
GlijankerTige de dilatation lisse
Gleitanker

Art. Nr.	EAN Code	d [mm]	l [mm]	
FG0526001063005	5410439567794	6	300	100

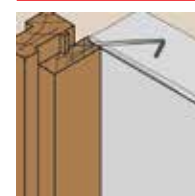

FG0531

Window frame anchor wood thread
Kozijnanker met houtdraadFixation de chambranle filet bois
Zargenanker mit Holzgewinde

Art. Nr.	EAN Code	d [mm]	l [mm]	h [mm]	
FG0531001061505	5410439233057	6	150	40	100
FG0531001062005	5410439233064	6	200	50	100
FG0531001062505	5410439233071	6	250	60	100

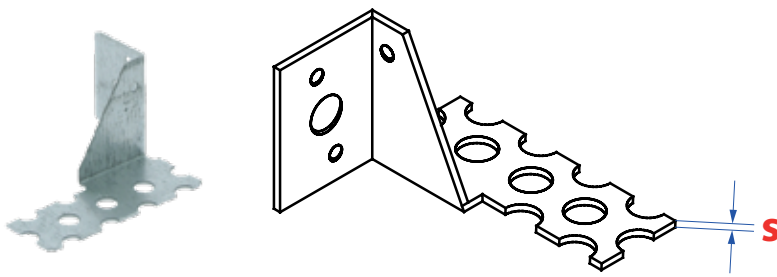

FG0534

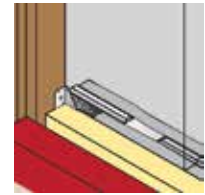

Frame anchor - l + r
Lijmkozijnanker - l + r

Ancre chambranle à coller - g + d
Zargenanker zum verkleben - l + r



Art. Nr.	EAN Code	s [mm]	Hole pattern Dia. of the hole/nr. of holes	
FG05340010000015	5410439568043	1	Ø4/3 - Ø6/1 - Ø8/3	100

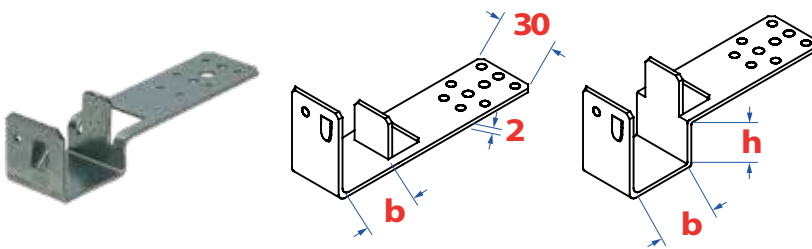

FG0563

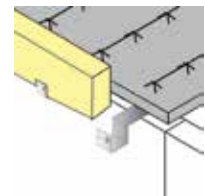

Rim shuttering anchor
Randbekistingsanker

Ancrage pour margelle
Randschalungsanker



Art. Nr.	EAN Code	b [mm]	h [mm]	Hole pattern Dia. of the hole/nr. of holes	
FG05630010320005	5410439646826	32	-	Ø3/5 - Ø4,5/2 - Ø6,5/1	100
FG05630010320125	5410439646840	32	12	Ø3/7 - Ø4,5/2 - Ø6,5/1	100
FG05630010320225	5410439646864	32	22	Ø3/7 - Ø4,5/2 - Ø6,5/1	100
FG05630010320325	5410439646888	32	32	Ø3/5 - Ø4,5/2 - Ø6,5/1	100

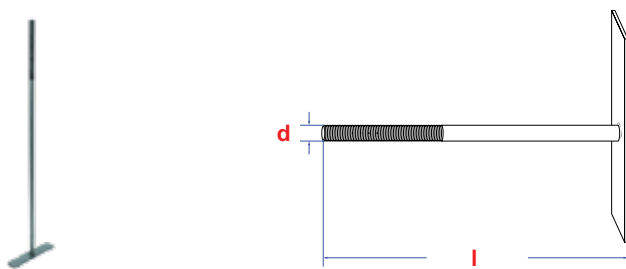

FG0586

Wall anchor plate centre
Muurplaatanker plaat centrisch

Tirant de mur plaque centrée
Steinanker platte zentrisch

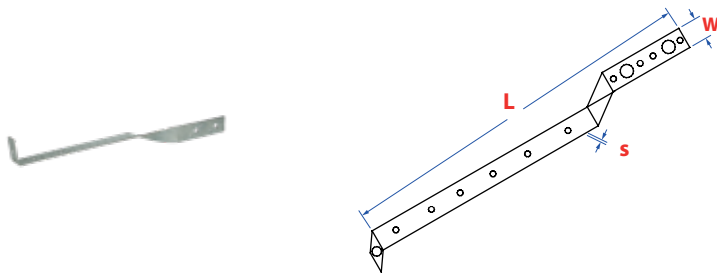

Art. Nr.	EAN Code	d [mm]	l [mm]	
FG05860011206005	5410439280037	12	600	10

**FG0599**

Storm anchor
Stormanker

Ancrage tempête
Windsoganker

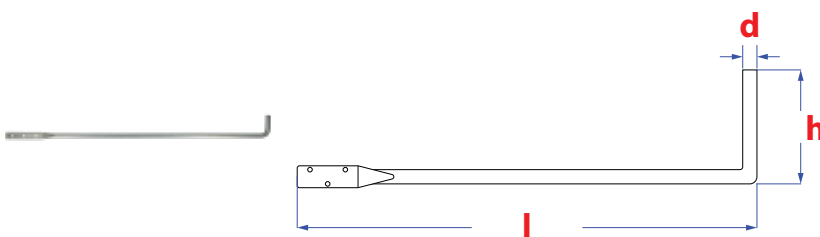

Art. Nr.	EAN Code	w [mm]	l [mm]	s [mm]	Hole pattern Dia. of the hole/nr. of holes	
FG05990010304005	5410439360869	30	400	2	Ø3,7/10 - Ø8,8/2	25

**FG0601**

Storm anchorage
Opwaaianker

Ancrage tempête
Windsoganker

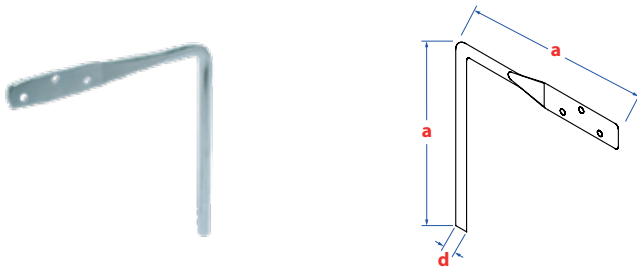

Art. Nr.	EAN Code	d [mm]	l [mm]	Hole pattern Dia. of the hole/nr. of holes	
FG06010011006005	5410439568104	10	600	Ø3/6	25

**FG0606**

Cramp iron
Bintanker

Ancrage bois/maçonnerie
Balkenanker



Art. Nr.	EAN Code	d [mm]	a [mm]	Hole pattern Dia. of the hole/nr. of holes	
FG06060012402405	5410439568128	14,5	240	Ø3/7	20

FG0651

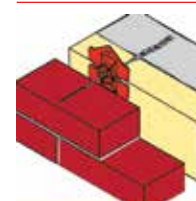
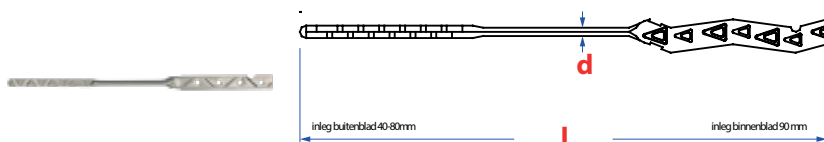

Thin joint tie
Prikspouwanker

Crochet mur creux à coller
Prik-Luftschichtanker



Art. Nr.	EAN Code	d [mm]	l [mm]	
FG0651A000402505	5410439568791	4	250	500
FG0651A000402805	5410439568807	4	280	500
FG0651A000403105	5410439379908	4	310	500

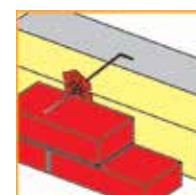
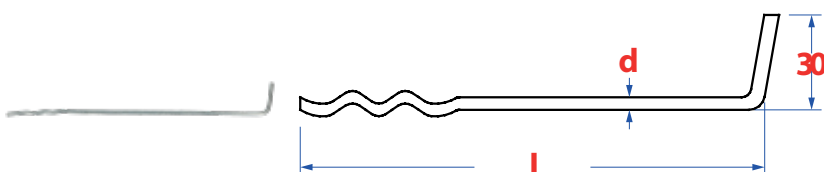

FG0661



Universal wall tie - L type
Universeel L-spouwanker

Crochet mur en L universel
Universeel L-Luftschichtanker

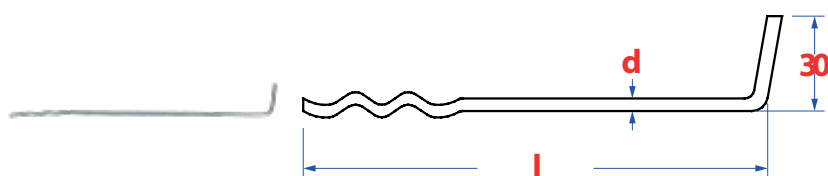
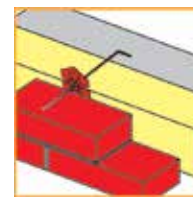

Art. Nr.	EAN Code	d [mm]	l [mm]		
FG06610013602304	5410439481304	3,6	230	100	100
FG06610013602604	5410439481540	3,6	260	100	100
FG06610013602904	5410439481557	3,6	290	100	100

**FG0661**

Universal wall tie - L type
Universeel L-spouwanker

Crochet mur en L universel
Universeel L-Luftschichtanker



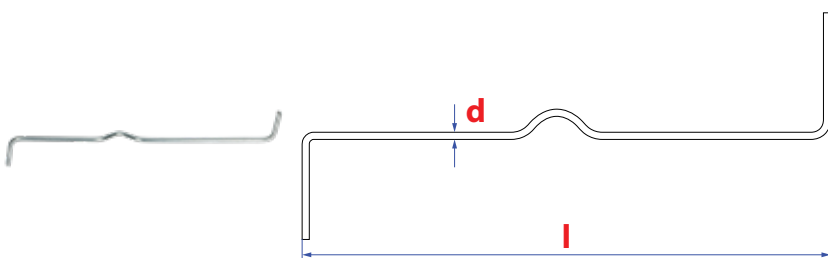

Art. Nr.	EAN Code	d [mm]	l [mm]	
FG06610013602005	5410439568814	3,6	200	250
FG06610013602305	5410439568838	3,6	230	250
FG06610013602605	5410439569279	3,6	260	250
FG06610013602905	5410439569286	3,6	290	250

**FG0663**

Wall tie - Mono
Spouwanker - Mono

Crochet mur - Mono
Luftschichtanker - Mono

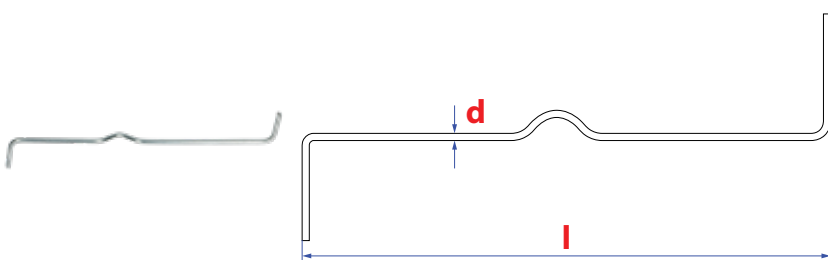

Art. Nr.	EAN Code	d [mm]	l [mm]		
FG06630013201804	5410439481199	3,2	180	100	100
FG06630013502104	5410439481205	3,5	210	100	100

**FG0663**

Wall tie - Mono
Spouwanker - Mono

Crochet mur - Mono
Luftschichtanker - Mono



Art. Nr.	EAN Code	d [mm]	l [mm]	
FG06630013201805	5410439169264	3,2	180	1000
FG06630013502105	5410439169271	3,5	210	500

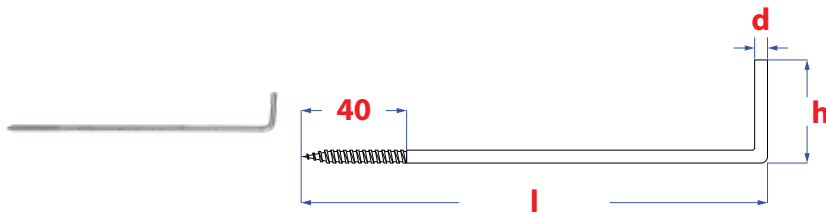

FG0664

Wall tie with wood thread - L type
L-spouwanker met houtdraad

Crochet mur à filet bois - Type L
Luftschichtanker mit Holzgewinde - Typ L



Art. Nr.	EAN Code	d [mm]	l [mm]	
FG06640013501804	5410439481250	3,5	180	100
FG06640013502104	5410439481298	3,5	210	100

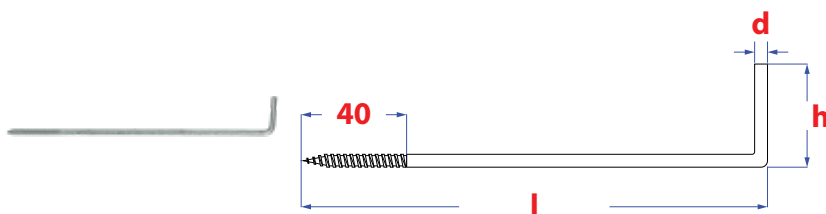

FG0664

Wall tie with wood thread - L type
L-spouwanker met houtdraad

Crochet mur à filet bois - Type L
Luftschichtanker mit Holzgewinde - Typ L



Art. Nr.	EAN Code	d [mm]	l [mm]	
FG06640013501805	5410439055895	3,5	180	1000
FG06640013502105	5410439169295	3,5	210	500

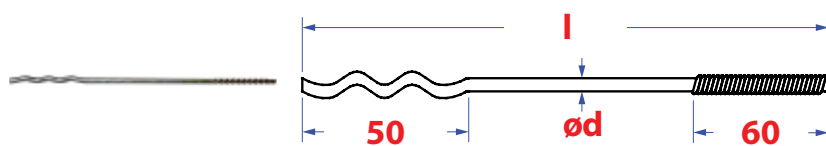

FG0671

Selftapping wall tie
Slagspouwanker

Crochet mur creux à clouer
Dübelanker mit Einschlaggewinde



Art. Nr.	EAN Code	d [mm]	l [mm]		
FG06710014002504	5410439481601	4	250	100	100
FG06710014002754	5410439481700	4	275	100	100

FG0671

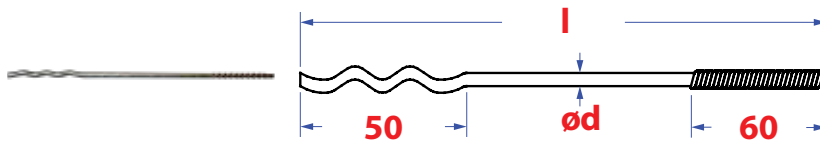

Selftapping wall tie
Slagspouwanker

Crochet mur creux à clouer
Dübelanker mit Einschlaggewinde



Art. Nr.	EAN Code	d [mm]	l [mm]	
FG06710014001905	5410439569293	4	190	250
FG06710014002205	5410439569309	4	220	250
FG06710014002505	5410439569316	4	250	250
FG06710014002755	5410439623803	4	275	250

The information in this catalogue is intended for general guidance only. We are not responsible for any (printing) errors, and we reserve the right of taking technical modifications and modifications in our product range without prior notice.

Aansprakelijkheid in gevolge van drukfouten wordt uitgesloten en veranderingen in het assortiment worden voorbehouden. Niets uit deze publicatie mag verveelvoudigd of openbaar gemaakt worden op gelijk welke wijze zonder voorafgaande schriftelijke toestemming van de uitgever.

Les informations reprises dans ce catalogue sont à titre général uniquement. Nous ne sommes pas responsables d'éventuelles erreurs d'impression et nous nous réservons le droit d'apporter des modifications aussi bien sur le plan technique que dans notre gamme de produits sans remarque au préalable.

Irrtümer, technische und Sortimentänderungen bleiben vorbehalten. Haftung für Druckfehler und -mängel wird ausgeschlossen.



At pgb-Europe
we invest in
green energy on
a daily base.

Follow us via

LinkedIn, Instagram,
Facebook & Youtube

Contact us.

pgb-Europe

Logistics centre

Gontrode Heirweg 170
9090 Melle
Belgium
T: +32 9 272 70 70
info@pgb-europe.com

www.pgb-europe.com

pgb-Polska

Production plant

Ul. Fryderyka
Wilhelma Redena 3
41 - 807 Zabrze, Polska
T: +48 (32) 330 26 10
biuro@pgb-polska.com

www.pgb-polska.com

pgb-France

Sales office

25 Rue du Champ des Oiseaux
59230 Saint-Amand-les-Eaux
France
T: +33 (0)3 27 21 56 80
info@pgb-france.com

www.pgb-france.com