



**Technical and Test Institute
for Construction Prague**

Prosecká 811/76a
190 00 Prague
Czech Republic
eota@tzus.cz



Member of



www.eota.eu

European Technical Assessment

**ETA 19/0151
of 14/03/2019**

Technical Assessment Body issuing the ETA: Technical and Test Institute
for Construction Prague

Trade name of the construction product

SMART S-RE1

**Product family to which the construction
product belongs**

Product area code: 33
Bonded injection type anchor for use in
cracked and uncracked concrete

Manufacturer

pgb-Polska Sp. z o.o.,
ul. Fryderyka Wilhelma Redena 3
41-807 Zabrze
Polska

Manufacturing plant

pgb-Polska Sp. z o.o.
Plant 1

**This European Technical Assessment
contains**

18 pages including 15 Annexes which form
an integral part of this assessment.

**This European Technical Assessment is
issued in accordance with regulation
(EU) No 305/2011, on the basis of**

EAD 330499-00-0601

Translations of this European Technical Assessment in other languages shall fully correspond to the original issued document and should be identified as such.

Communication of this European Technical Assessment, including transmission by electronic means, shall be in full (excepted the confidential Annex(es) referred to above). However, partial reproduction may be made, with the written consent of the issuing Technical Assessment Body - Technical and Test Institute for Construction Prague. Any partial reproduction has to be identified as such.

1. Technical description of the product

The SMART S-RE1 with steel elements is bonded anchor (injection type).

Steel elements can be galvanized or stainless steel threaded rod or rebar.

Steel element is placed into a drilled hole filled with injection mortar. The steel element is anchored via the bond between metal part, injection mortar and concrete. The anchor is intended to be used with embedment depth from 4 diameters to 20 diameters.

The illustration and the description of the product are given in Annex A.

2. Specification of the intended use in accordance with the applicable EAD

The performances given in Section 3 are only valid if the anchor is used in compliance with the specifications and conditions given in Annex B.

The provisions made in this European Technical Assessment are based on an assumed working life of the anchor of 50 years. The indications given on the working life cannot be interpreted as a guarantee given by the producer, but are to be regarded only as a means for choosing the products in relation to the expected economically reasonable working life of the works.

3. Performance of the product and references to the methods used for its assessment

3.1 Mechanical resistance and stability (BWR 1)

Essential characteristic	Performance
Static and quasi-static loading	
Resistance to steel failure (tension)	See Annex C1, C2
Resistance to combined pull-out and concrete failure	See Annex C1, C2
Resistance to concrete cone failure	See Annex C1, C2
Edge distance to prevent splitting under load	See Annex C1, C2
Robustness	See Annex C1, C2
Maximum setting torque moment	See Annex B3
Minimum edge distance and spacing	See Annex B3
Resistance to steel failure (shear)	See Annex C3, C4
Resistance to pry-out failure	See Annex C3, C4
Resistance to concrete edge failure	See Annex C3, C4
Displacements under short term and long term loading	See Annex C5, C6
Durability of metal parts	See Annex A3
Seismic performance C1	
Resistance to steel failure	See Annex C7
Resistance to pull-out	See Annex C7
Factor for annular gap	See Annex C7

3.2 Hygiene, health and environment (BWR 3)

No performance determined.

3.3 General aspects relating to fitness for use

Durability and serviceability are only ensured if the specifications of intended use according to Annex B 1 are kept.

4. Assessment and verification of constancy of performance (AVCP) system applied with reference to its legal base

According to the Decision 96/582/EC of the European Commission¹ the system of assessment verification of constancy of performance (see Annex V to Regulation (EU) No 305/2011) given in the following table apply.

Product	Intended use	Level or class	System
Metal anchors for use in concrete	For fixing and/or supporting to concrete, structural elements (which contributes to the stability of the works) or heavy units	-	1

5. Technical details necessary for the implementation of the AVCP system, as provided in the applicable EAD

5.1 Tasks of the manufacturer

The manufacturer may only use raw materials stated in the technical documentation of this European Technical Assessment.

The factory production control shall be in accordance with the control plan which is a part of the technical documentation of this European Technical Assessment. The control plan is laid down in the context of the factory production control system operated by the manufacturer and deposited at Technical and Test Institute for Construction Prague.² The results of factory production control shall be recorded and evaluated in accordance with the provisions of the control plan.

5.2 Tasks of the notified bodies

The notified body shall retain the essential points of its actions referred to above and state the results obtained and conclusions drawn in a written report.

The notified certification body involved by the manufacturer shall issue a certificate of constancy of performance stating the conformity with the provisions of this European Technical Assessment.

In cases where the provisions of the European Technical Assessment and its control plan are no longer fulfilled the notified body shall withdraw the certificate of constancy of performance and inform Technical and Test Institute for Construction Prague without delay.

Issued in Prague on 14.03.2019

By

Ing. Mária Schaan

Head of the Technical Assessment Body

¹ Official Journal of the European Communities L 254 of 08.10.1996

² The control plan is a confidential part of the documentation of the European Technical Assessment, but not published together with the ETA and only handed over to the approved body involved in the procedure of AVCP.

Threaded rod

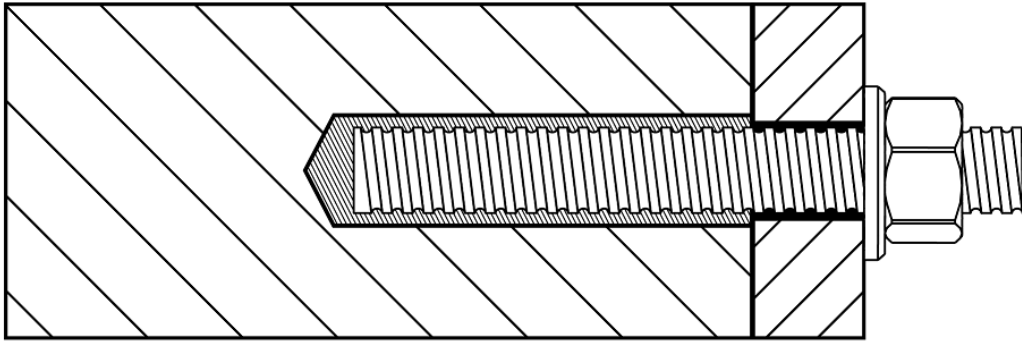

Reinforcing bar

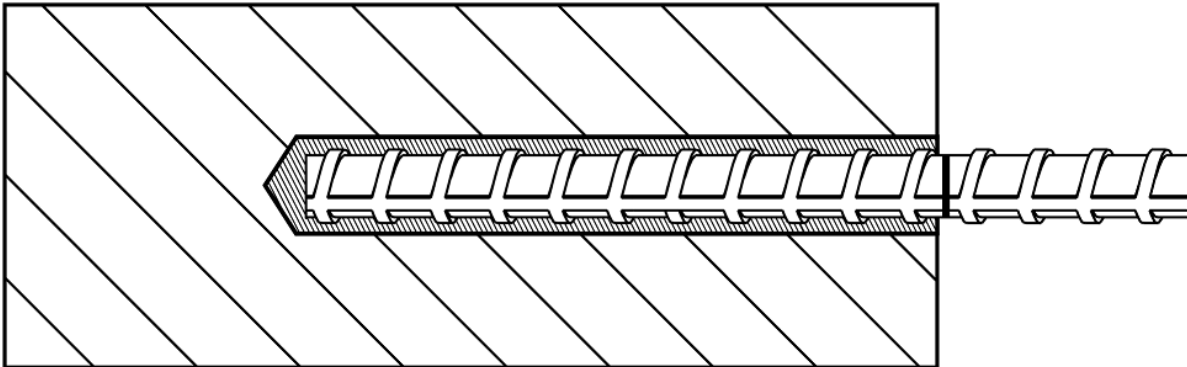

SMART S-RE1

Product description
Installed conditions

Annex A 1

Universal cartridge

SMART S-RE1 250 ml



Side by side cartridge

SMART S-RE1 400 ml

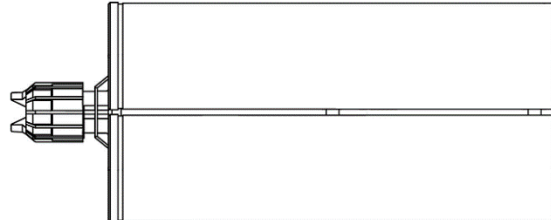

SMART S-RE1 600 ml
650 ml

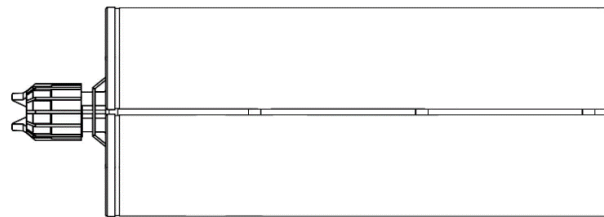

SMART S-RE1 1500 ml

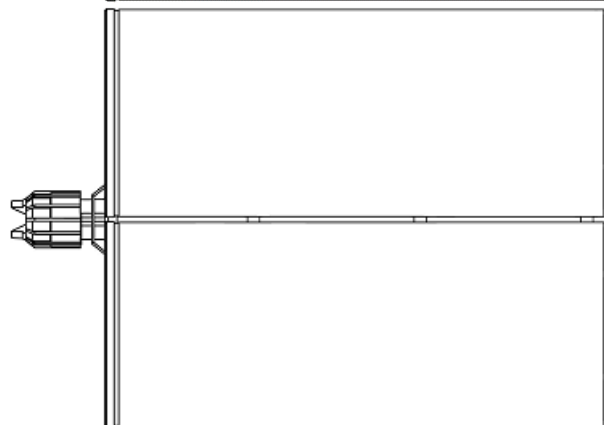

Marking of the mortar cartridges

Identifying mark of the producer, Trade name, Charge code number, Storage life, Curing and processing time

Mixing nozzle

SMCH4-05

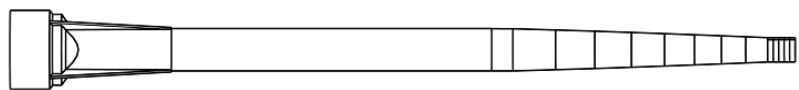

SMCH4-07

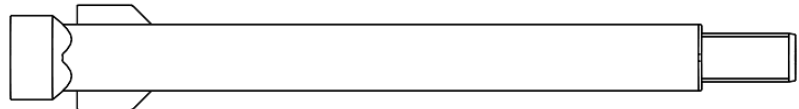
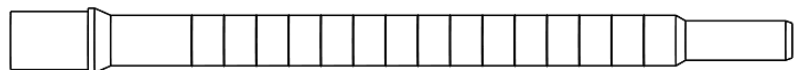

SMCH4-20 SMART EasyFlow

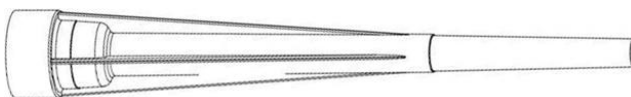

SMART S-RE1

Product description
Injection system

Annex A 2

Threaded rod M10, M12, M16, M20, M24, M30

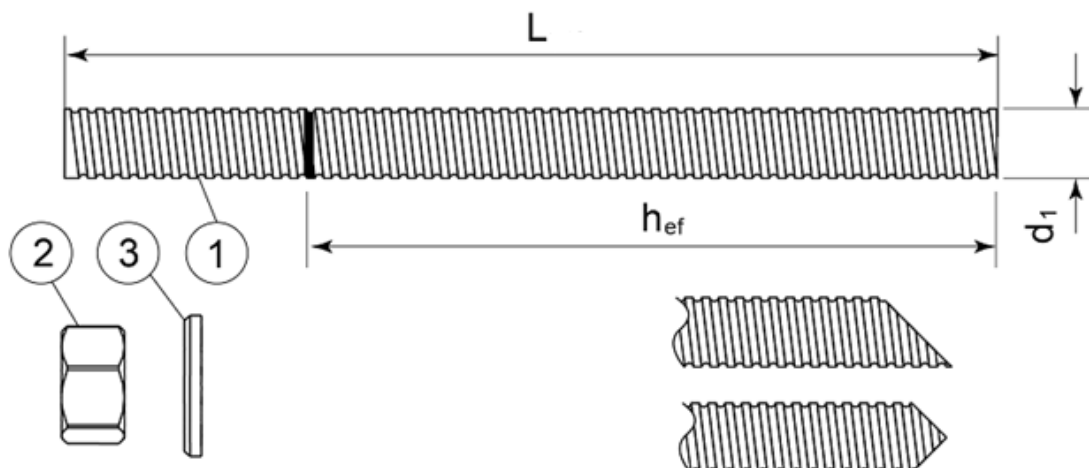

Standard commercial threaded rod with marked embedment depth

Part	Designation	Material
Steel, zinc plated $\geq 5 \mu\text{m}$ acc. to EN ISO 4042 or Steel, Hot-dip galvanized $\geq 40 \mu\text{m}$ acc. to EN ISO 1461 and EN ISO 10684		
1	Anchor rod	Steel, EN 10087 or EN 10263 Property class 5.8, 8.8, 10.9* EN ISO 898-1
2	Hexagon nut EN ISO 4032	According to threaded rod, EN 20898-2
3	Washer EN ISO 887, EN ISO 7089, EN ISO 7093 or EN ISO 7094	According to threaded rod
Stainless steel		
1	Anchor rod	Material: A2-70, A4-70, A4-80, EN ISO 3506
2	Hexagon nut EN ISO 4032	According to threaded rod
3	Washer EN ISO 887, EN ISO 7089, EN ISO 7093 or EN ISO 7094	According to threaded rod
High corrosion resistant steel 1.4529		
1	Anchor rod	Material: 1.4529, EN 10088-1
2	Hexagon nut EN ISO 4032	According to threaded rod
3	Washer EN ISO 887, EN ISO 7089, EN ISO 7093 or EN ISO 7094	According to threaded rod

*Galvanized rod of high strength are sensitive to hydrogen induced brittle failure

SMART S-RE1

Product description
Threaded rod and materials

Annex A 3

Rebar Ø10, Ø12, Ø16, Ø20, Ø25, Ø32



Standard commercial reinforcing bar with marked embedment depth

Product form		Bars and de-coiled rods	
Class		B	C
Characteristic yield strength f_{yk} or $f_{0,2k}$ (MPa)		400 to 600	
Minimum value of $k = (f_t/f_y)_k$		$\geq 1,08$	$\geq 1,15$ < 1,35
Characteristic strain at maximum force ϵ_{uk} (%)		$\geq 5,0$	$\geq 7,5$
Bendability		Bend/Rebend test	
Maximum deviation from nominal mass (individual bar) (%)	Nominal bar size (mm) ≤ 8	$\pm 6,0$	
	> 8	$\pm 4,5$	
Bond: Minimum relative rib area, $f_{R,min}$	Nominal bar size (mm) 8 to 12	0,040	
	> 12	0,056	

SMART S-RE1

Product description
Rebars and materials

Annex A 4

Specifications of intended use

Anchorage subject to:

- Static and quasi-static load.
- Seismic actions category C1 (max w = 0,5 mm): threaded rods

Base materials

- Cracked and uncracked concrete.
- Reinforced or unreinforced normal weight concrete of strength class C20/25 at minimum and C50/60 at maximum according EN 206-1:2000-12.

Temperature range:

- Ta) -40°C to +40°C (max. short. term temperature +40°C and max. long term temperature +24°C)
- Tb) -40°C to +70°C (max. short. term temperature +70°C and max. long term temperature +40°C)
- Tc) -40°C to +80°C (max. short. term temperature +80°C and max. long term temperature +40°C)

Use conditions (Environmental conditions)

- (X1) Structures subject to dry internal conditions (zinc coated steel, stainless steel, high corrosion resistance steel).
- (X2) Structures subject to external atmospheric exposure (including industrial and marine environment) and to permanently damp internal condition, if no particular aggressive conditions exist (stainless steel A4, high corrosion resistant steel).
- (X3) Structures subject to external atmospheric exposure and to permanently damp internal condition, if other particular aggressive conditions exist (high corrosion resistant steel).

Note: Particular aggressive conditions are e.g. permanent, alternating immersion in seawater or the splash zone of seawater, chloride atmosphere of indoor swimming pools or atmosphere with extreme chemical pollution (e.g. in desulphurization plants or road tunnels where de-icing materials are used).

Concrete conditions:

- I1 – installation in dry or wet (water saturated) concrete and use in service in dry or wet concrete.

Design:

- The anchorages are designed in accordance with the EN 1992-4 or EOTA Technical Report TR 055 under the responsibility of an engineer experienced in anchorages and concrete work.
- Verifiable calculation notes and drawings are prepared taking account of the loads to be anchored. The position of the anchor is indicated on the design drawings.
- Anchorages under seismic actions (cracked concrete) have to be designed in accordance with EN 1992-4.

Installation:

- Hole drilling by hammer drill mode.
- Anchor installation carried out by appropriately qualified personnel and under the supervision of the person responsible for technical matters of the site.

Installation direction:

- D2 – downward and horizontal installation

SMART S-RE1

**Intended use
Specifications**

Annex B 1

Applicator gun

A



B



C



D



E



Cartridge	Applicator gun
Universal 250	A
Side by Side 400	B
Side by Side 600, 650	C, D
Side by Side 1500	E

SMCH3 SDS



SMCH3 EXTSDS-250



Size	M10	M12	M16	M20	M24	M30
Steel brush head diameter [mm]	S14HF	S16HF	S22HF	S24HF	S31HF	S38HF
Steel brush head length [mm]	75					
Min. overall brush length [mm]	110					

Size	Ø10	Ø12	Ø16	Ø20	Ø25	Ø32
Steel brush head diameter [mm]	S16HF	S18HF	S22HF	S27HF	S35HF	S43HF
Steel brush head length [mm]	75					
Min. overall brush length [mm]	110					

SMART S-RE1

Intended use
 Applicator guns
 Cleaning brush

Annex B 2

Table B1: Installation parameters of threaded rod

Size		M10	M12	M16	M20	M24	M30
Nominal drill hole diameter	$\varnothing d_0$ [mm]	12	14	18	22	26	35
Diameter of cleaning brush	d_b [mm]	S14HF	S16HF	S22HF	S24HF	S31HF	S38HF
Torque moment	$\max T_{fix}$ [Nm]	20	40	80	135	200	270
Depth of drill hole for $h_{ef,min}$	$h_0 = h_{ef}$ [mm]	60	70	80	90	96	120
Depth of drill hole for $h_{ef,max}$	$h_0 = h_{ef}$ [mm]	200	240	320	400	480	600
Minimum edge distance	c_{min} [mm]	40	40	45	50	55	65
Minimum spacing	s_{min} [mm]	40	40	45	50	55	65
Minimum thickness of member	h_{min} [mm]	$h_{ef} + 30 \text{ mm} \geq 100 \text{ mm}$			$h_{ef} + 2d_0$		

Table B2: Installation parameters of rebar

Size		Ø10	Ø12	Ø16	Ø20	Ø25	Ø32
Nominal drill hole diameter	$\varnothing d_0$ [mm]	14	16	20	25	32	40
Diameter of cleaning brush	d_b [mm]	S16HF	S18HF	S22HF	S27HF	S35HF	S43HF
Torque moment	T_{inst} [Nm]	20	40	80	135	200	270
Depth of drill hole for $h_{ef,min}$	$h_0 = h_{ef}$ [mm]	60	70	80	90	100	128
Depth of drill hole for $h_{ef,max}$	$h_0 = h_{ef}$ [mm]	200	240	320	400	500	640
Minimum edge distance	c_{min} [mm]	40	40	45	50	55	65
Minimum spacing	s_{min} [mm]	40	40	45	50	55	65
Minimum thickness of member	h_{min} [mm]	$h_{ef} + 30 \text{ mm} \geq 100 \text{ mm}$			$h_{ef} + 2d_0$		

Table B3: Minimum curing time

Concrete temperature [°C]	Gel time [minutes]	Cure time [hours]
+5 to +10	20	24
+10 to +15		12
+15 to +20	15	8
+20 to +25	11	7
+25 to +30	8	6
+30 to +35	6	5
+35 to +40	4	4
+40	3	3
Cartridge must be conditioned to minimum +10°C		

SMART S-RE1

Intended use
Installation parameters
Curing time

Annex B 3

Installation procedure

Before commencing installation ensure the operative is equipped with appropriate personal protection equipment, SDS Hammer Drill, Air, Hole Cleaning Brush, good quality Dispensing Tool – either manual or power operated, Chemical cartridge with mixing nozzle and extension tube, if needed.

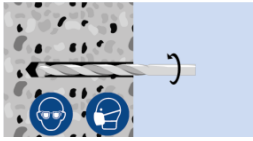

1/ Using the SDS Hammer Drill in rotary hammer mode for drilling, with a carbide tipped drill bit of the appropriate size, drill the hole to the specified hole diameter and depth

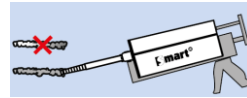

8/ Extrude some resin to waste until an even-colored mixture is extruded, The cartridge is now ready

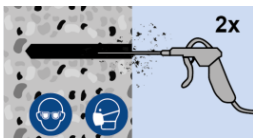

2/ Insert the Air Lance to the bottom of the hole and depress the trigger for 2 seconds. The compressed air must be clean – free from water and oil – and at a minimum pressure of 6bar (90psi). **Perform the blowing operation twice.**

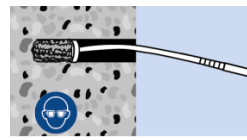

9/ Attach an extension tube with resin stopper (if required) to the end of the mixing nozzle with a push fit (The extension tubes may be pushed into the resin stoppers and are held in place with a coarse internal thread).

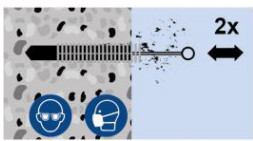

3/ Select the correct size Hole Cleaning Brush. Ensure that the brush is in good condition and the correct diameter. Insert the brush to the bottom of the hole, using a brush extension if needed to reach the bottom of the hole and withdraw with a twisting motion. There should be positive interaction between the steel bristles of the brush and the sides of the drilled hole. **Perform the brushing operation twice.**

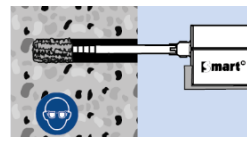

10/ Insert the mixing nozzle to the bottom of the hole. Extrude the resin and slowly withdraw the nozzle from the hole. **Ensure no air voids are created** as the nozzle is withdrawn. Inject resin until the hole is approximately ¾ full and remove the nozzle from the hole.

4/ Repeat 2

5/ Repeat 3

6/ Repeat 2

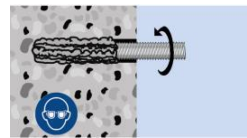

11/ Select the steel anchor element ensuring it is free from oil or other contaminants, and mark with the required embedment depth. Insert the steel element into the hole using a back and forth twisting motion to ensure complete cover, until it reaches the bottom of the hole. Excess resin will be expelled from the hole evenly around the steel element and there shall be no gaps between the anchor element and the wall of the drilled hole.

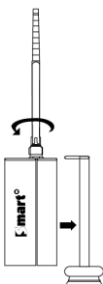

7/ Select the appropriate static mixer nozzle, checking that the mixing elements are present and correct. Do not modify the mixer. Attach mixer nozzle to the cartridge. Check the Dispensing Tool is in good working order. Place the cartridge into the dispensing tool.
Note: The SMCH4-07 is in two sections. One section contains the mixing elements and the other section is an extension piece. Connect the extension piece to the mixing section by pushing the two sections firmly together until a positive engagement is felt.

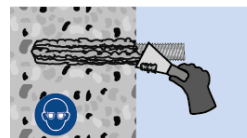

12/ Clean any excess resin from around the mouth of the hole

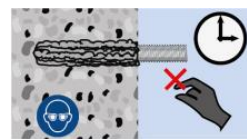

13/ Do not disturb the anchor until at least the minimum cure time has elapsed. Refer to the Working and Load Timetable to determine the appropriate cure time

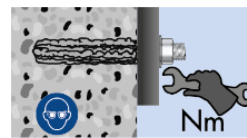

14/ Position the fixture and tighten the anchor to the appropriate installation torque.

Do not over-torque the anchor as this could adversely affect its performance.

SMART S-RE1

Intended use
Installation instructions

Annex B 4

Table C1: Design method EN 1992-4
Characteristic values of resistance to tension load of threaded rod

Steel failure – Characteristic resistance									
Size			M10	M12	M16	M20	M24	M30	
Steel grade 5.8	$N_{Rk,s}$	[kN]	29	42	79	123	177	281	
Partial safety factor	γ_{Ms}	[-]	1,5						
Steel grade 8.8	$N_{Rk,s}$	[kN]	46	67	126	196	282	449	
Partial safety factor	γ_{Ms}	[-]	1,5						
Steel grade 10.9*	$N_{Rk,s}$	[kN]	58	84	157	245	353	561	
Partial safety factor	γ_{Ms}	[-]	1,4						
Stainless steel grade A2-70, A4-70	$N_{Rk,s}$	[kN]	41	59	110	172	247	393	
Partial safety factor	γ_{Ms}	[-]	1,9						
Stainless steel grade A4-80	$N_{Rk,s}$	[kN]	46	67	126	196	282	449	
Partial safety factor	γ_{Ms}	[-]	1,6						
Stainless steel grade 1.4529	$N_{Rk,s}$	[kN]	41	59	110	172	247	393	
Partial safety factor	γ_{Ms}	[-]	1,5						

Combined pullout and concrete cone failure in uncracked concrete C20/25								
Size			M10	M12	M16	M20	M24	M30
Characteristic bond resistance in uncracked concrete C20/25								
Temperature a) -40°C to +40°C	$\tau_{Rk,ucr}$	[N/mm ²]	11	11	11	11	12	10
Temperature b) -40°C to +70°C	$\tau_{Rk,ucr}$	[N/mm ²]	5	5	5	5	5,5	4,5
Temperature c) -40°C to +80°C	$\tau_{Rk,ucr}$	[N/mm ²]	4,5	4	4	4	4,5	4
Installation safety factor	$\gamma_2^{(1)} = \gamma_{inst}^{(2)}$	[-]	1,2	1,4				
Factor for uncracked concrete C30/37			1,12					
Factor for uncracked concrete C40/50	ψ_c		1,23					
Factor for uncracked concrete C50/60			1,30					
Characteristic bond resistance in cracked concrete C20/25								
Temperature a) -40°C to +40°C	$\tau_{Rk,cr}$	[N/mm ²]	8,5	8,5	8,5	5,5	5,5	5,5
Temperature b) -40°C to +70°C	$\tau_{Rk,cr}$	[N/mm ²]	3,5	3,5	4	2	2	2
Temperature c) -40°C to +80°C	$\tau_{Rk,cr}$	[N/mm ²]	3	3	3	2	2	2
Partial safety factor	$\gamma_2^{(1)} = \gamma_{inst}^{(2)}$	[-]	1,2	1,4				
Factor for cracked concrete C30/37			1,03					
Factor for cracked concrete C40/50	ψ_c		1,06					
Factor for cracked concrete C50/60			1,07					

Concrete cone failure			
Factor for concrete cone failure for uncracked concrete	$k_1^{(1)}$ $k_{ucr,N}^{(2)}$	[-]	10,1
Factor for concrete cone failure for cracked concrete	$k_1^{(1)}$ $k_{cr,N}^{(2)}$		7,2
Edge distance	$C_{cr,N}$	[mm]	$1,5h_{ef}$

Splitting failure								
Size			M10	M12	M16	M20	M24	M30
Edge distance	$C_{cr,sp}$	[mm]	$1,0 \cdot h_{ef} \leq 2,0 \cdot h_{ef} \cdot \left(2,5 - \frac{h}{h_{ef}} \right) \leq 2,4 \cdot h_{ef}$					
Spacing	$S_{cr,sp}$	[mm]	$2 \cdot C_{cr,sp}$					
Partial safety factor	γ_{Msp}	[-]	1,8					

¹⁾ Design according EOTA Technical Report TR 055

²⁾ Design according EN 1992-4:2016

SMART S-RE1

Performances

Design according to EN 1992-4
Characteristic resistance for tension loads - threaded rod

Annex C 1

Table C2: Design method EN 1992-4
Characteristic values of resistance to tension load of rebar

Steel failure – Characteristic resistance									
Size			Ø10	Ø12	Ø16	Ø20	Ø25	Ø32	
Rebar BSt 500 S	$N_{Rk,s}$	[kN]	43	62	111	173	270	442	
Partial safety factor	γ_{Ms}	[-]	1,4						

Combined pullout and concrete cone failure in uncracked concrete C20/25								
Size			Ø10	Ø12	Ø16	Ø20	Ø25	Ø32
Characteristic bond resistance in uncracked concrete C20/25								
Temperature a) -40°C to +40°C	$\tau_{Rk,ucr}$	[N/mm ²]	11	11	12	12	12	12
Temperature b) -40°C to +70°C	$\tau_{Rk,ucr}$	[N/mm ²]	5	5	5,5	5,5	5,5	5,5
Temperature c) -40°C to +80°C	$\tau_{Rk,ucr}$	[N/mm ²]	4,5	4,5	4,5	4,5	4,5	4,5
Installation safety factor	$\gamma_2^{(1)} = \gamma_{inst}^{(2)}$	[-]	1,2	1,4				
Factor for uncracked concrete C30/37			1,06					
Factor for uncracked concrete C40/50	ψ_c		1,11					
Factor for uncracked concrete C50/60			1,14					
Characteristic bond resistance in cracked concrete C20/25								
Temperature a) -40°C to +40°C	$\tau_{Rk,cr}$	[N/mm ²]	8,5	8,5	6,5	6,5	4,5	4,5
Temperature b) -40°C to +70°C	$\tau_{Rk,cr}$	[N/mm ²]	3,5	3,5	2,5	2,5	1,5	1,5
Temperature c) -40°C to +80°C	$\tau_{Rk,cr}$	[N/mm ²]	3	3	2	2	1,5	1,5
Partial safety factor	$\gamma_2^{(1)} = \gamma_{inst}^{(2)}$	[-]	1,2	1,4				
Factor for cracked concrete C30/37			1,04					
Factor for cracked concrete C40/50	ψ_c		1,07					
Factor for cracked concrete C50/60			1,09					

Concrete cone failure			
Factor for concrete cone failure for uncracked concrete	$k_1^{(1)}$ $k_{ucr,N}^{(2)}$	[-]	10,1
Factor for concrete cone failure for cracked concrete	$k_1^{(1)}$ $k_{cr,N}^{(2)}$		7,2
Edge distance	$C_{cr,N}$	[mm]	$1,5h_{ef}$

Splitting failure								
Size			Ø10	Ø12	Ø16	Ø20	Ø25	Ø32
Edge distance	$C_{cr,sp}$	[mm]	$1,0 \cdot h_{ef} \leq 2,0 \cdot h_{ef} \cdot \left(2,5 - \frac{h}{h_{ef}} \right) \leq 2,4 \cdot h_{ef}$					
Spacing	$S_{cr,sp}$	[mm]	$2 \cdot C_{cr,sp}$					
Partial safety factor	γ_{Msp}	[-]	1,8					

¹⁾ Design according EOTA Technical Report TR 055

²⁾ Design according EN 1992-4:2016

SMART S-RE1

Performances

Design according to EN 1992-4

Characteristic resistance for tension loads - rebar

Annex C 2

Table C3: Design method EN 1992-4
Characteristic values of resistance to shear load of threaded rod

Steel failure without lever arm									
Size			M10	M12	M16	M20	M24	M30	
Steel grade 5.8	$V_{Rk,s}$	[kN]	15	21	39	61	88	140	
Partial safety factor	γ_{Ms}	[-]	1,25						
Steel grade 8.8	$V_{Rk,s}$	[kN]	23	34	63	98	141	224	
Partial safety factor	γ_{Ms}	[-]	1,25						
Steel grade 10.9*	$V_{Rk,s}$	[kN]	29	42	79	123	177	281	
Partial safety factor	γ_{Ms}	[-]	1,5						
Stainless steel grade A2-70, A4-70	$V_{Rk,s}$	[kN]	20	30	55	86	124	196	
Partial safety factor	γ_{Ms}	[-]	1,56						
Stainless steel grade A4-80	$V_{Rk,s}$	[kN]	23	34	63	98	141	224	
Partial safety factor	γ_{Ms}	[-]	1,33						
Stainless steel grade 1.4529	$V_{Rk,s}$	[kN]	20	30	55	86	124	196	
Partial safety factor	γ_{Ms}	[-]	1,25						
Characteristic resistance of group of fasteners									
Ductility factor $k_7 = 1,0$ for steel with rupture elongation $A_5 > 8\%$									

Steel failure with lever arm									
Size			M10	M12	M16	M20	M24	M30	
Steel grade 5.8	$M^o_{Rk,s}$	[N.m]	37	66	166	325	561	1125	
Partial safety factor	γ_{Ms}	[-]	1,25						
Steel grade 8.8	$M^o_{Rk,s}$	[N.m]	60	105	266	519	898	1799	
Partial safety factor	γ_{Ms}	[-]	1,25						
Steel grade 10.9*	$M^o_{Rk,s}$	[N.m]	75	131	333	649	1123	2249	
Partial safety factor	γ_{Ms}	[-]	1,50						
Stainless steel grade A2-70, A4-70	$M^o_{Rk,s}$	[N.m]	52	92	233	454	786	1574	
Partial safety factor	γ_{Ms}	[-]	1,56						
Stainless steel grade A4-80	$M^o_{Rk,s}$	[N.m]	60	105	266	519	898	1799	
Partial safety factor	γ_{Ms}	[-]	1,33						
Stainless steel grade 1.4529	$M^o_{Rk,s}$	[N.m]	52	92	233	454	786	1574	
Partial safety factor	γ_{Ms}	[-]	1,25						
Concrete pryout failure									
Factor for resistance to pry-out failure k_8								2	

Concrete edge failure									
Size			M10	M12	M16	M20	M24	M30	
Outside diameter of fastener	d_{nom}	[mm]	10	12	16	20	24	30	
Effective length of fastener	l_f	[mm]	min (h_{ef} , 8 d_{nom})						

SMART S-RE1

Performances

Design according to EN 1992-4
Characteristic resistance for shear loads - threaded rod

Annex C 3

Table C4: Design method EN 1992-4
Characteristic values of resistance to shear load of rebar

Steel failure without lever arm							
Size		Ø10	Ø12	Ø16	Ø20	Ø25	Ø32
Rebar BSt 500 S	$V_{Rk,s}$ [kN]	22	31	55	86	135	221
Partial safety factor	γ_{Ms} [-]	1,5					
Characteristic resistance of group of fasteners							
Ductility factor $k_7 = 1,0$ for steel with rupture elongation $A_5 > 8\%$							

Steel failure with lever arm							
Size		Ø10	Ø12	Ø16	Ø20	Ø25	Ø32
Rebar BSt 500 S	$M^o_{Rk,s}$ [N.m]	65	112	265	518	1013	2122
Partial safety factor	γ_{Ms} [-]	1,5					
Concrete pryout failure							
Factor for resistance to pry-out failure	k_8 [-]	2					

Concrete edge failure							
Size		Ø10	Ø12	Ø16	Ø20	Ø25	Ø32
Outside diameter of fastener	d_{nom} [mm]	10	12	16	20	25	32
Effective length of fastener	l_f [mm]	min (h_{ef} , 8 d_{nom})					

SMART S-RE1

Performances

Design according to EN 1992-4
Characteristic resistance for shear loads - rebar

Annex C 4

Table C5: Displacement of threaded rod

Tension load

Anchor size			M10	M12	M16	M20	M24	M30
Uncracked concrete								
40°C / 24°C	δ_{N0}	[mm/(N/mm ²)]	0,080	0,092	0,118	0,143	0,168	0,206
	$\delta_{N\infty}$	[mm/(N/mm ²)]	0,080	0,092	0,118	0,143	0,168	0,206
70°C / 40°C	δ_{N0}	[mm/(N/mm ²)]	0,113	0,131	0,167	0,203	0,239	0,293
	$\delta_{N\infty}$	[mm/(N/mm ²)]	0,176	0,204	0,260	0,316	0,371	0,455
80°C / 40°C	δ_{N0}	[mm/(N/mm ²)]	0,113	0,131	0,167	0,203	0,239	0,293
	$\delta_{N\infty}$	[mm/(N/mm ²)]	0,176	0,204	0,260	0,316	0,371	0,455
Cracked concrete								
40°C / 24°C	δ_{N0}	[mm/(N/mm ²)]	0,119	0,136	0,168	0,201	0,234	0,283
	$\delta_{N\infty}$	[mm/(N/mm ²)]	0,119	0,136	0,168	0,201	0,234	0,283
70°C / 40°C	δ_{N0}	[mm/(N/mm ²)]	0,119	0,136	0,168	0,201	0,234	0,283
	$\delta_{N\infty}$	[mm/(N/mm ²)]	0,179	0,204	0,253	0,303	0,352	0,426
80°C / 40°C	δ_{N0}	[mm/(N/mm ²)]	0,119	0,136	0,168	0,201	0,234	0,283
	$\delta_{N\infty}$	[mm/(N/mm ²)]	0,179	0,204	0,253	0,303	0,352	0,426

Shear load

Anchor size			M10	M12	M16	M20	M24	M30
Uncracked concrete								
All temperatures	δ_{V0}	[mm/(N/mm ²)]	0,23	0,16	0,09	0,05	0,04	0,04
	$\delta_{V\infty}$	[mm/(N/mm ²)]	0,47	0,32	0,17	0,11	0,08	0,08

SMART S-RE1

Performances
Displacement for threaded rod

Annex C 5

Table C6: Displacement of rebar

Tension load

Anchor size		Ø10	Ø12	Ø16	Ø20	Ø25	Ø32	
Uncracked concrete								
40°C / 24°C	δ_{N0}	[mm/(N/mm ²)]	0,080	0,092	0,118	0,143	0,174	0,206
	$\delta_{N\infty}$	[mm/(N/mm ²)]	0,080	0,092	0,118	0,143	0,174	0,206
70°C / 40°C	δ_{N0}	[mm/(N/mm ²)]	0,113	0,131	0,167	0,203	0,248	0,293
	$\delta_{N\infty}$	[mm/(N/mm ²)]	0,176	0,204	0,260	0,316	0,385	0,455
80°C / 40°C	δ_{N0}	[mm/(N/mm ²)]	0,113	0,131	0,167	0,203	0,248	0,293
	$\delta_{N\infty}$	[mm/(N/mm ²)]	0,176	0,204	0,260	0,316	0,385	0,455
Cracked concrete								
40°C / 24°C	δ_{N0}	[mm/(N/mm ²)]	0,119	0,136	0,168	0,201	0,242	0,283
	$\delta_{N\infty}$	[mm/(N/mm ²)]	0,119	0,136	0,168	0,201	0,242	0,283
70°C / 40°C	δ_{N0}	[mm/(N/mm ²)]	0,115	0,131	0,163	0,195	0,235	0,274
	$\delta_{N\infty}$	[mm/(N/mm ²)]	0,179	0,204	0,253	0,303	0,365	0,426
80°C / 40°C	δ_{N0}	[mm/(N/mm ²)]	0,115	0,131	0,163	0,195	0,235	0,274
	$\delta_{N\infty}$	[mm/(N/mm ²)]	0,179	0,204	0,253	0,303	0,365	0,426

Shear load

Anchor size		Ø10	Ø12	Ø16	Ø20	Ø25	Ø32	
Uncracked concrete								
All temperatures	δ_{V0}	[mm/(N/mm ²)]	0,23	0,16	0,09	0,05	0,04	0,04
	$\delta_{V\infty}$	[mm/(N/mm ²)]	0,47	0,32	0,17	0,11	0,08	0,08

SMART S-RE1
Performances
 Displacement for rebar
Annex C 6

Table C7: Reduction factors for seismic design category C1 for threaded rods

Size		M10	M12	M16	M20	M24	M30
Tension load							
Steel failure							
Characteristic resistance grade 5.8	$N_{Rk,s,eq}$ [kN]	29,0	42,2	78,5	122,5	176,5	280,5
Characteristic resistance grade 8.8	$N_{Rk,s,eq}$ [kN]	46,4	67,4	125,6	196,0	282,4	448,8
Characteristic resistance grade 10.9	$N_{Rk,s,eq}$ [kN]	58,0	84,3	157,0	245,0	353,0	561,0
Characteristic resistance A2-70, A4-70	$N_{Rk,s,eq}$ [kN]	40,6	59,0	109,9	171,5	247,1	392,7
Characteristic resistance A4-80	$N_{Rk,s,eq}$ [kN]	46,4	67,4	125,6	196,0	282,4	448,8
Characteristic resistance 1.4529	$N_{Rk,s,eq}$ [kN]	40,6	59,0	109,9	171,5	247,1	392,7
Combined pull-out and concrete cone failure							
Factor for calculation of $\tau_{Rk,eq}$ ¹⁾	$\alpha_{N,seis}$	-	1,00	0,96	0,79	0,79	0,68
Shear load							
Steel failure without lever arm							
Characteristic resistance grade 5.8	$V_{Rk,s,eq}$ [kN]	13,5	19,6	36,5	61,3	86,3	140,3
Characteristic resistance grade 8.8	$V_{Rk,s,eq}$ [kN]	21,6	32,3	58,4	98,0	141,2	224,4
Characteristic resistance grade 10.9	$V_{Rk,s,eq}$ [kN]	27,0	39,2	73,0	122,5	176,5	280,5
Characteristic resistance A2-70, A4-70	$V_{Rk,s,eq}$ [kN]	18,9	27,4	51,2	85,8	123,6	196,4
Characteristic resistance A4-80	$V_{Rk,s,eq}$ [kN]	21,6	31,3	58,4	98,0	141,2	224,4
Characteristic resistance 1.4529	$V_{Rk,s,eq}$ [kN]	18,9	27,4	51,2	85,8	123,6	196,4
Factor for annular gap	α_{gap} [-]	0,5					

¹⁾ $\tau_{Rk,eq} = \alpha_{N,seis} \times \tau_{Rk,cr}$

Note: Rebars are not qualified for seismic design

SMART S-RE1

Performances
Reduction factors for seismic design

Annex C 7